

PAPER • OPEN ACCESS

Assessment of validated geoelectrical resistivity methods to reconstruct buried archaeological site (case study: Beteng Site-Sidomekar, Jember Regency)

To cite this article: Supriyadi *et al* 2019 *J. Phys.: Conf. Ser.* **1153** 012026

View the [article online](#) for updates and enhancements.



IOP | ebooks™

Bringing you innovative digital publishing with leading voices to create your essential collection of books in STEM research.

Start exploring the collection - download the first chapter of every title for free.

Assessment of validated geoelectrical resistivity methods to reconstruct buried archaeological site (case study: Beteng Site- Sidomekar, Jember Regency)

Supriyadi, Agus Suprianto, Nurul Priyantari, Bowo Eko Cahyono, Imroatus Sholeha

Physics Dept, Mathematics and Natural Science Faculty, University of Jember
Jl. Kalimantan III/25 Kampus Tegalboto Jember, 68121

E-mail: supriyadi@unej.ac.id

Abstract. Jember Regency has many relics of historical objects spread in some sub-districts, one of which is Beteng Site located in Sidomekar Village, Semboro Sub district - Jember. Beteng site is one of the relics of the Majapahit period, with an area of 93,5 m x 40,5 m. Inside of the site, there is red brick which is the vestige of the castle's foundation, a small part exposed on the surface and most still buried beneath the soil surface. The real condition of the Beteng Site with its limitations interesting to further investigated about its relevance to the history of the Majapahit Kingdom and the reconstruction of the fortress design and its function based on the mapping of the foundation of the building. The result of laboratory measurement of exposed red brick resistivity value is 17,5 Ωm . The used values as a reference for analysing the field measurement results with 2D geo-electrical resistivity methods using Wenner-Schlumberger configuration. The measurement result using the geo-electrical resistivity method shows that the resistivity value of 22.1 Ωm - 25,0 Ωm in every line with depth 1 m - 2 m. This is quite close to the results of laboratory measurements, so it is presumed to be a red brick layer. Based on the distribution result of resistivity value in every line and real condition in the form of an exposed red brick, distribution of artifacts can be mapped to estimate the design of the foundation building of the castle's vestige.

1. Introduction

Beteng site is a region about 93.5 x 40.5 m, used as cultural heritage in Jember. This site is a relic of the Majapahit Kingdom located in the hamlet of Beteng, village Sidomekar, sub-district of Semboro, district of Jember. Within site, there is the house of Beteng gatekeeper and a mini-museum containing objects of artifacts found in the area of Beteng Site. In addition to these objects, the remnants of the red brick which is the remains of the foundation of the building of the fort exposed on the surface, and some are still buried beneath the soil surface around the house gatekeeper of this site.

Red brick is a building element made of clay with or without additional material, printed in blocks, then burned with a high temperature[1]. Generally, red brick is made of a mixture of clay and silt sand that has resistivity 15 – 150 Ωm [2]. This resistivity value have range limits that are too wide and not specific to the type of Majapahit relics red bricks so that the necessary measurement it as the resistivity values in-situ on the Beteng Site. The analysis of in-situ resistivity values of the samples can be use as Beteng Site reference in justification of subsequent research results using the geoelectrical resistivity method. Geoelectrical resistivity method is one of the geophysical method studies the physical properties of subsurface rocks or objects. This method aims at describing the distribution of the resistivity value



subsurface of the earth from measurements on the surface of the earth [3]. A geoelectrical resistivity method can provide information on the value of resistivity associated with the objects ancient relic's artifacts in subsurface [4; 5].

While on a surface of homogeneous media there are two current electrodes circuit, i.e. C_1 and C_2 with a limited distance and between current electrode there are potential electrode i.e P_1 and P_2 with close proximity (Figure 1), and then electric potential on the adjacent points on the surface will be influenced by both the current electrode [4]. The potential P_1 caused by C_1 is:

$$V_1 = -\frac{A_1}{r_1}; \quad A_1 = -\frac{I\rho}{2\pi} \tag{1}$$

Potential P_2 caused by C_2 is:

$$V_2 = -\frac{A_2}{r_2}; \quad A_2 = -A_1 = \frac{I\rho}{2\pi} \tag{2}$$

Potential in point P_1 induced by current C_1 and C_2 be:

$$V_1 + V_2 = \frac{I\rho}{2\pi} \left(\frac{1}{r_1} - \frac{1}{r_2} \right) \tag{3}$$

Potential difference at the point P_2 can be determined in the same way, so that the potential difference between the P_1 and P_2 is:

$$\Delta V = \frac{I\rho}{2\pi} \left[\left(\frac{1}{r_1} - \frac{1}{r_2} \right) - \left(\frac{1}{r_3} - \frac{1}{r_4} \right) \right] \tag{4}$$

or

$$\Delta V = \frac{I\rho}{K} \tag{5}$$

K is the geometry factor which depends on the electrode arrangement. The value of K can be obtained if the distance between the electrodes has been known and followed by reading ΔV between P_1 and P_2 and the injected current. For the value potential difference ΔV and current I usually can be read directly out of the tool, and the value of the apparent resistivity can be obtained by the equation:

$$\rho_a = K \frac{\Delta V}{I} \tag{6}$$

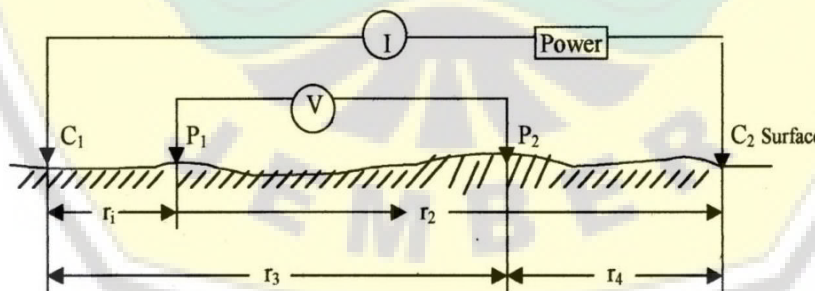

Figure 1. Two current sources and two potential electrodes on the surface of a homogeneous isotropic medium [6].

Wenner-Schlumberger configuration is the configuration with constant spacing rules and comparison factor "n" i.e. comparison of the distance between electrodes AM with MN (Figure 2). When the distance between the electrode potential of MN is a then the distance between the electrode current (A and B) is $2na + a$ [6].

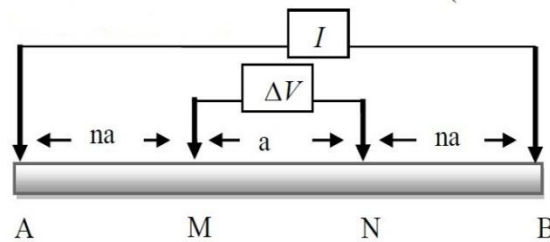

Figure 2. The arrangement of electrodes configuration Wenner-Schlumberger [6].

The Wenner-Schlumberger configuration sensitive enough to map the structure vertically or horizontally. The penetration depth of this configuration is better 10% than Wenner configuration for the same distance between the outer electrodes (C_1 and C_2). This configuration is also superior to the coverage data horizontally compared to the Wenner configuration [3; 6]. The electrodes arrangement of Wenner-Schlumberger configuration shows in Figure 2. The apparent resistivity value for the Wenner-Schlumberger configuration can be calculated using equation 6 with geometry factor K is:

$$K = n(n + 1)\pi a \tag{7}$$

where a is the distance between electrodes M and N [6].

The artifacts that are estimated to still present under the surface is the Foundation of the red brick building since there are outcrops of red brick in the area the site of Beteng. The outcrop shaped like a insulated room's. Basic materials commonly used to make bricks are baked clay soil with a high temperature of about 500 °C made traditionally [7]. Traditional manufacturing results in different sizes, colors and shapes. Clay soil as the main material in making red brick has a resistivity value of 1 Ωm – 100 Ωm. Red bricks in Majapahit period have resistivity value near with recent red brick, where the resistivity of the red brick on the of Beteng site is 17.5 Ωm [8].

2. Experimental Methods

Steps of the comprehensive plan of the research conducted are shown in the flowchart in Figure 3. To measure the resistivity value of red brick, the first prepared the tools and materials of red brick, the adapter/power supply regulator circuit, current, plate zinc, copper wires, and a multimeter. The equipment assembled like Figure 4.

On the measurement of the resistivity value of red brick in the laboratory, the resulting data in the form of the value of the current (I) and voltage (V). Based on these two data, the resistivity of the red brick can be calculated by using Ohm's law:

$$R = \frac{V}{I} \tag{8}$$

$$\rho = R \frac{A}{L} \tag{9}$$

Sampling rocks and the location of the research carried out at the Beteng site, the hamlet of Beteng, village Sidomekar, sub-district Semboro. The location of the research are on coordinates 08°12'0" S and 113°27'0" E. The research in Beteng site is based on the information that in this site still contained artifacts and the remains of the buildings are still buried in subsurface.

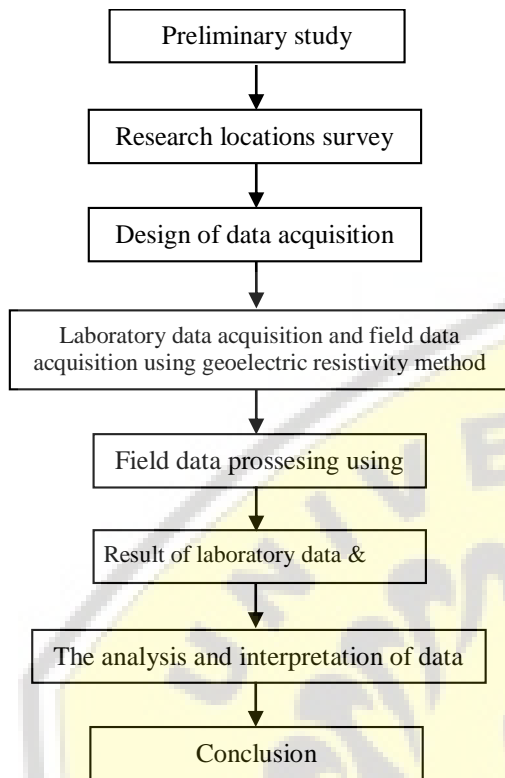

Figure 3. Flowchart steps of the research.

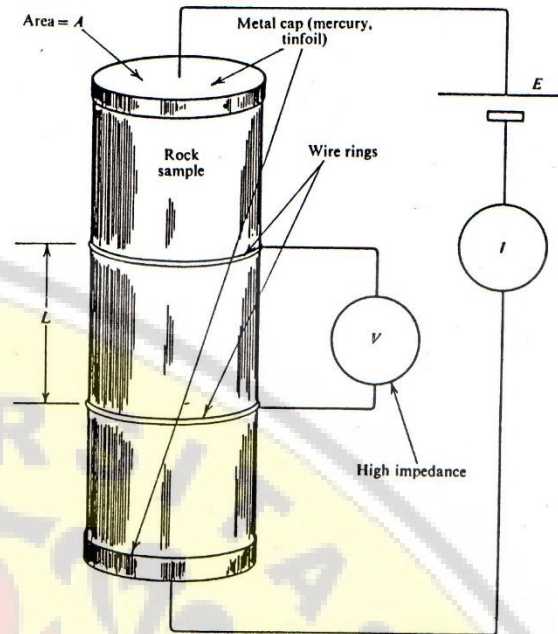

Figure 4. Measurement equipment of red brick resistivity value in the laboratory.

Data mapping acquisition in the Beteng Site area consists of 6 lines with 2 lines along 40 m, 2 lines along 36 m, 1 line along 30 m, and 1 line along 60 m. Position of 3 lines are located in front of the mini museum, 2 other line are located in the back of the mini museum and the longest line is 60 m beside the mini museum. Some lines pass rock outcrops, the former brick foundation of building the fort. Data acquisition is performed using a geoelectrical resistivity method Wenner-Schlumberger configuration with the electrode spacing of 2 m. The rules shift spacing in Wenner-Schlumberger described in Figure 2. Sketch the line of the acquisition of the data shown in Figure 5 & 6.

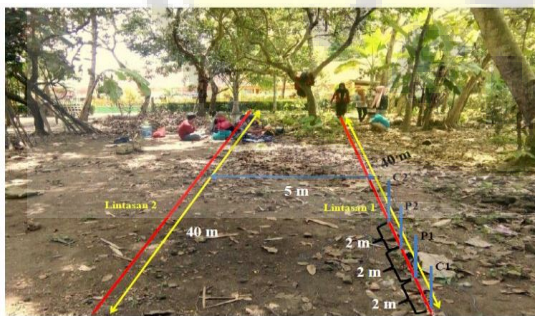

Figure 5. Sketch the line data acquisition in the field in back of mini museum.

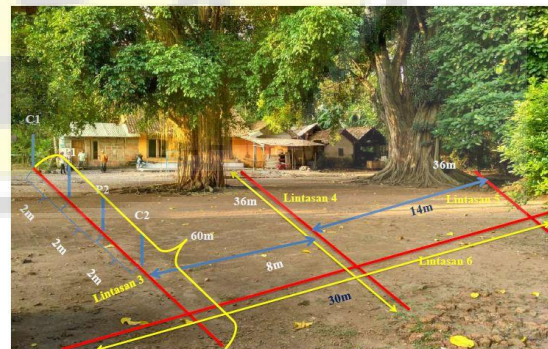

Figure 6. Sketch the line data retrieval in a field that is in front of Beteng Site Museum.

Data obtained on the acquisition of the data field are in the form of an electric current and potential difference. The data is processed to get the apparent resistivity value by using equation 6 with geometry factor as equation 7 and then inverted to produce a 2-dimensional resistivity cross section. Based on the

resistivity value of red brick samples the results of laboratory measurements, 2-dimensional resistivity cross section from geoelectrical resistivity measurement and information on the field, can be estimated depth and shape of the building foundation at the Beteng Site.

3. Results and Discussion

Measurements on red brick resistivity are performed using five samples. In this study measured the value of voltage and current of sampel using equipment as in Figure 4. Voltage and current are measured, then calculated with equation (8) and (9) so that the obtained values of red brick resistivity. From the five samples obtained from different locations on the Beteng site, the average value of red brick resistivity i.e., $15.73 \Omega\text{m}$. This resistivity value of the red brick is used as a reference for the interpretation of resistivity cross sections resulting from geoelectrical resistivity measurements.

Based on the results of the interpretation of resistivity cross sections for 6 line, constituent layers of rock can be found in subsurface of Beteng Site. Types of rocks constituents subsurface are relatively the same in each line, i.e., type of a layer of clay and silt. This type of tampering with the subsurface layer of Beteng Site namely silt and silty clays, wet soil, silt, sand, and red brick. Objects are artifacts that can be seen from the results of the geoelectric investigation is the red brick building of the foundation of the former fortress.

To clarify the result of interpretation of the subsurface, then do the merge between the line. The merger between the line aims to find out the correlation between the one with the other.

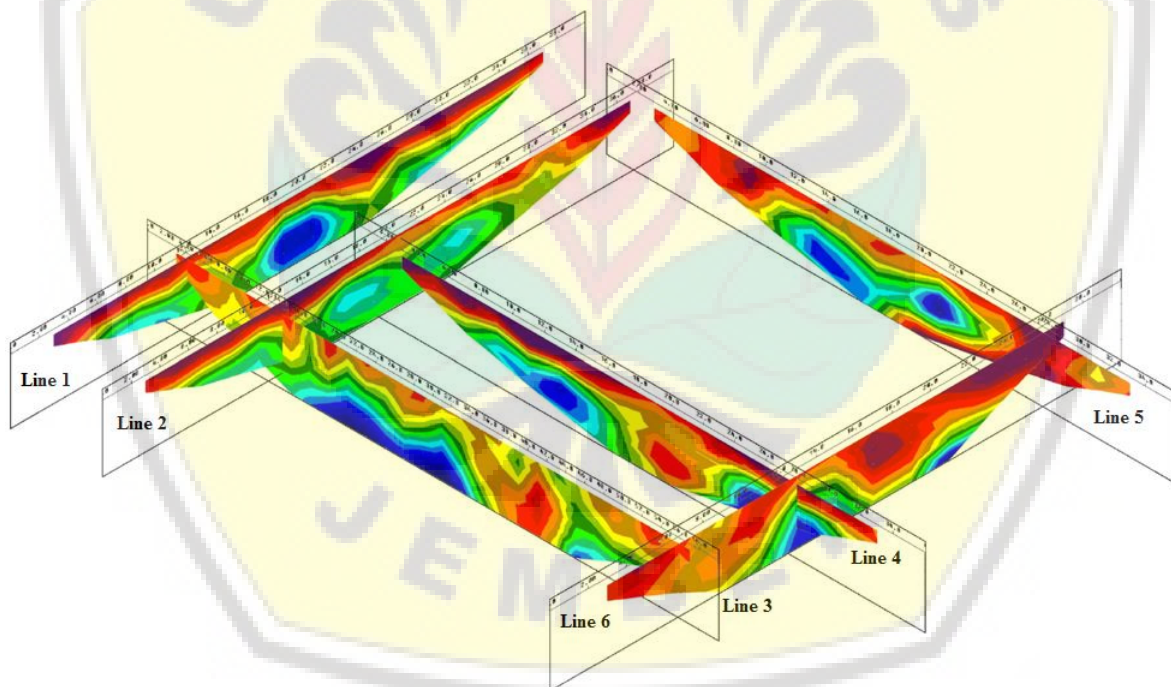

Figure 7. Vertical cross section resulting from intersection of the 6 lines.

Figure 7 show that there are strong correlation between each line is combined i.e color image similarity. Based on Figure 7, it can be seen that the type of layer contained in the Beteng Site area is dominated by the type of clay layer i.e silty clay and soft wet silt and sandy silt soil with resistivity value $3,75 \Omega\text{m}$ - $19,0 \Omega\text{m}$. The inversion results from the 6 lines obtained the highest resistivity values from each line that ranged from $22.1 \Omega\text{m}$ - $25.0 \Omega\text{m}$ which was imaged with dark red to purple allegedly as red bricks layer. The resistivity value which is thought to be a red brick is generally at a depth ranging between 1 m - 2 m. Resistivity value of red bricks is not only found in sub surface that there are red brick outcrops, but also at a depth of 3.9 m - 6.91 m.

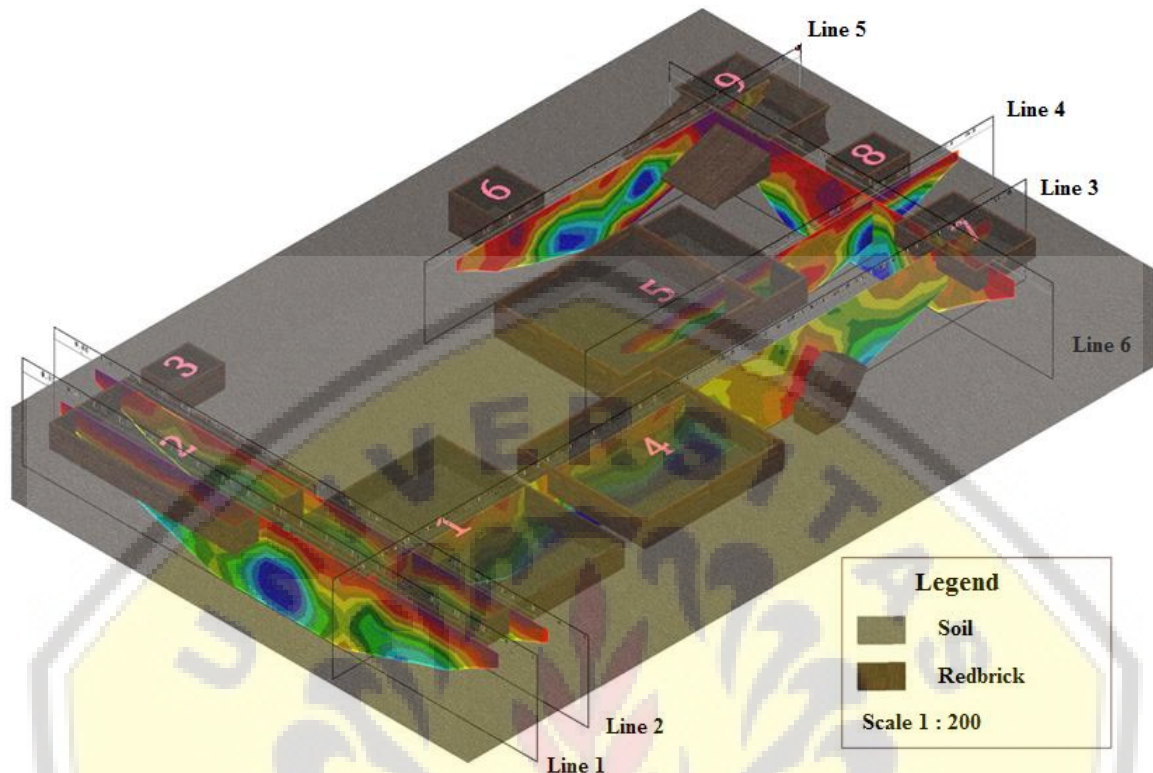

Figure 8. Estimation of the former construction of building foundations within the Benteng Site area based on the results of data acquisition and field conditions.

Figure 8 is the prediction of the shape of the former construction of fortress buildings in the Beteng Site area.. The sketch of the building has a length of 60 m and a width of 40 m. Estimation of the shape of building construction is based on the results of geoelectrical resistivity data acquisition and real conditions in the field. The results of data acquisition indicate that there are a resistivity value that are thought to be the resistivity value of red bricks scattered on each line. Estimation of the shape of building construction is also based on real conditions in the field where the red brick outcrops at the research location also assist in making estimates of the shape of the building's construction. In estimating the construction of the building that is made, each building made has a different area because the type of layer that is thought to be red brick is scattered at different measurement points on each line.

In room 1 it is estimated to have a length of 16 m, a width of 13 m, and a depth of foundation 2 m. Determination of the size of room 1 based on the combination of line 1, line 2, and line 3. At line 1 and line 2, the resistivity value of the red brick is spread along 16 m from the measurement point 3 m to 19 m. Line 1 and 2 are parallel line intersect with line 3 where on line 3 there is also a 13 m brick resistivity value from the measurement point 3 m to 16 m. Room 2 has a length of 16 m which is found at the measurement point of 21 m to 37 m with a depth of 2 m. Room 3 has a small size which is 3 m long and 2 m wide. Determination of the size in room 3 based on the resistivity value of the bricks found on line 2, those found at the measurement point of 34 m-37 m. Room 4 has a length of 12 m and a width of 11 m where this room is crossed by line 3 which has a brick resistivity value at the measurement point of 18 m to 30 m. The length size of room 4 is obtained from the resistivity value which is assumed to be the red brick layer on line 3 and the width is obtained from the outcrop of red bricks found on line 3 where the length of the 11 m brick outcrop. Room 5 has a length of 16 m and a width of 11 m, there are 2 stacking brick outcrops with a width of 11 m and a length of 12 m based on real conditions in the field. In rooms 6 and 8 are small room, room 6 has a length of 4 m and a width of 4 m while room 8 has a length of 4 m and a width of 3 m. Room 7 has a length of 7 m and a width of 5 m where the size is

obtained from the intersection between line 6 and line 3 which has a red brick resistivity value. Room 9 has a length of 9 m and a width of 4 m, the size is determined based on the intersection between line 5 and line 6. Room 9 has a different depth of foundation with another building which is 6.91 m. The depth estimation is based on the interpretation results on line 6, there is a resistivity value which is thought to be a red brick located at a depth of 1 m to 6.91 m.

In Figures 7 and 8, bricks are scattered in this area, so it is assumed that this area was once part of a large building in the form of a fortress building. The outcrops of a rectangular red brick that looks like a room, can be expected to be the rooms inside the fortress. Based on the results of geoelectrical resistivity investigations, the room has the same depth of foundation which is around 2 m and there are also remaining buildings at depths of up to 6.91 m. It can be concluded that in subsurface of this location there are still other buildings that are still buried.

4. Conclusion

On the area within the site of Beteng suspected ancient structures of the foundation in the form of red bricks with a resistivity value range between $23.6 \Omega\text{m}$ - $26.0 \Omega\text{m}$ at an average depth of 1 m-2 m. Resistivity values of rocks which are thought to be red bricks are generally along the bottom of the red brick outcrop. Based on the results of this research showed that the combination of red brick resistivity measurement in laboratory, resistivity cross section using geoelectrical resistivity method and real condition in the field can be used for effective prediction of subsurface structures especially especially in the field of archeology before excavation carry out.

5. References

- [1] Public Works Department (Departemen Pekerjaan Umum). 1987. Quality and Red Brick Solid Test (Mutu dan Uji Bata Merah Pejal) (SII-0021-1987). Bandung: Yayasan Lembaga Pendidikan Masalah Bangunan.
- [2] Hunt, R.E. 1984. Geotechnical Engineering Investigation Manual. Mc Graw Hill: New York.
- [3] Looke, M. H. 2004. Electrical Imaging Surveys for Environmental and Engineering Studies: A practical guide to 2-D and 3-D surveys. Malaysia: Penang.
- [4] Linford, N. 2006. The application of geophysical methods to archaeological prospection Reports. Progress Physics 69(7) p 2205
- [5] Alashloo, S.Y.M, S. Rosli, M.N.N. Nawai, M.M. Saidin, and M.M. Alashloo .2011. Magnetic and 2D Electrical Imaging Methods to Investigate an Archaeological Site at Sungai Batu, Kedah, Malaysia 3rd International Conference on Chemical, Biological and Environmental Engineering 20 p 42-48
- [6] Telford, W. M., Sherif, R. E., dan Geldart, L. P. 1990. Applied Geophysics Second Edition. New York: Cambridge University.
- [7] Kurniaty, D.R. 2010. Exposed Brick as an Alternative Wall Material for Building Design (Bata Ekspos sebagai Alternatif Material Dinding untuk Rancangan Bangunan). Ruang. 2(2): 45-52.
- [8] Supriyadi, N. Priyantari, & R.D. Sukmadewi. 2016. Resistivity Value as Characteristics Of Majapahit Kingdom Era Red Bricks, Proceeding 1st IBSC (International Basics Science Conference)- University Of Jember. ISBN 978-602-60569-5-5.