



**PERHITUNGAN RENCANA ANGGARAN BIAYA GEDUNG
EKONOMI AKUNTANSI FAKULTAS EKONOMI
UNIVERSITAS JEMBER**

PROYEK AKHIR

Oleh

Raditya Ramadhan Islami

NIM 131903103001

**PROGRAM STUDI DIPLOMA III TEKNIK
JURUSAN TEKNIK SIPIL
FAKULTAS TEKNIK
UNIVERSITAS JEMBER**

2017



**PERHITUNGAN RENCANA ANGGARAN BIAYA GEDUNG
EKONOMI AKUNTANSI FAKULTAS EKONOMI
UNIVERSITAS JEMBER**

PROYEK AKHIR

diajukan guna melengkapi tugas akhir dan memenuhi salah satu syarat
untuk menyelesaikan Program Studi Teknik Mesin (DIII)
dan mencapai gelar Ahli Madya

Oleh

Raditya Ramadhan Islami

NIM 131903103001

**PROGRAM STUDI DIPLOMA III TEKNIK
JURUSAN TEKNIK SIPIL
FAKULTAS TEKNIK
UNIVERSITAS JEMBER**

2017

PERSEMBAHAN

Laporan Proyek Akhir ini saya persembahkan untuk Ibunda Ika Rusfiyati dan Ayahanda Arif Wijaya (Alm) yang tercinta, terima kasih atas pengorbanan, usaha, kasih sayang, dorongan, nasehat dan air mata yang menetes dalam setiap untaian do'a yang senantiasa mengiringi setiap langkah bagi perjuangan dan keberhasilan penulis;

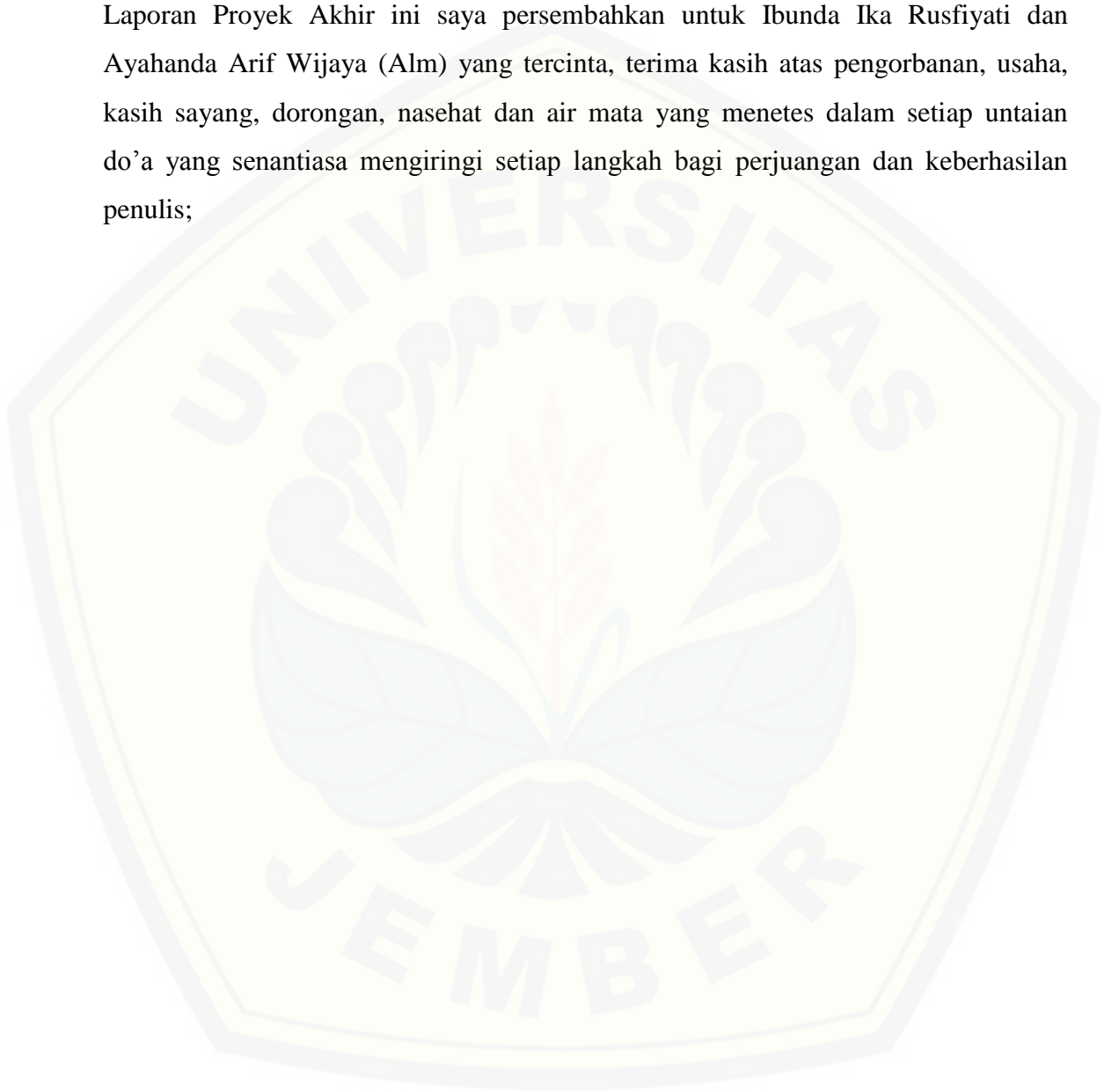

MOTTO

Ketika semua orang berharap menjadi luar biasa, saya hanya berharap menjadi biasa saja, karena biasa sajapun sudah luar biasa.

(Raditya Ramadhan I.)*)

atau

Kalau tujuan kuliah adalah untuk bekerja, ya setuju, bekerja menyelesaikan tugas kuliah.

(Pidi Baiq)*)



PERNYATAAN

Saya yang bertanda tangan di bawah ini:

Nama : Raditya Ramadhan Islami

NIM : 131903103001

Menyatakan dengan sesungguhnya bahwa proyek akhir yang berjudul “Perhitungan Rencana Anggaran Biaya Gedung Ekonomi Akuntansi Fakultas Ekonomi Universitas Jember”. adalah benar-benar hasil karya sendiri, kecuali kutipan yang sudah saya sebutkan sumbernya, belum pernah diajukan pada institusi manapun, dan bukan karya jiplakan. Saya bertanggung jawab atas keabsahan dan kebenaran isinya sesuai dengan sikap ilmiah yang harus dijunjung tinggi.

Demikian pernyataan ini saya buat dengan sebenarnya, tanpa ada tekanan dan paksaan dari pihak manapun serta bersedia mendapat sanksi akademik jika ternyata dikemudian hari pernyataan ini tidak benar.

Jember, 13 Desember 2017

Yang menyatakan,

Nama : Raditya Ramadhan Islami

NIM : 131903103001

TUGAS AKHIR

**PERHITUNGAN RENCANA ANGGARAN BIAYA GEDUNG EKONOMI
AKUNTANSI FAKULTAS EKONOMI UNIVERSITAS JEMBER**

Oleh

Raditya Ramadhan Islami
NIM 131903103001

Pembimbing:

Dosen Pembimbing Utama : Ir. Hernu Suyoso, M.T.

Dosen Pembimbing Anggota : Dr. Anik Ratnaningsih, S.T., M.T.

PENGESAHAN

Proyek akhir berjudul "Perhitungan Rencana Anggaran Biaya Gedung Ekonomi Akuntansi Fakultas Ekonomi Universitas Jember" telah diuji dan disahkan pada:

hari, tanggal :

tempat : Fakultas Teknik Jurusan Teknik Sipil

Pembimbing

Pembimbing I,

Pembimbing II,

Ir. Hernu Suyoso, M.T.
NIP 195511121987021001

Dr. Anik Ratnaningsih, S.T., M.T.
NIP 197005301998032001

Penguji

Penguji I,

Penguji II,

Dr. Dewi Junita K, S.T., M.T.
NIP 197106101999032001

Anita Trisiana, S.T., M.T.
NIP 198009232015042

Mengesahkan,

Dekan Fakultas Teknik Universitas Jember,

Dr. Ir. Entin Hidayah, M.U.M
NIP 19661215 199503 2 001

RINGKASAN

Perhitungan Rencana Anggaran Biaya Gedung Ekonomi Akuntansi Fakultas Ekonomi Universitas Jember ; Raditya Ramadhan Islami, 131903103001; 2017; 241 halaman; Jurusan Teknik Sipil Fakultas Teknik Universitas Jember.

Rencana Anggaran Biaya selalu berikatan dengan proses pembangunan proyek, rencana anggaran biaya akan dijadikan acuan untuk penjadwalan proyek, estimasi proyek, dan lain-lain. Maka dapat disimpulkan bahwa Rencana Anggaran Biaya adalah suatu perhitungan banyaknya biaya yang diperlukan untuk bahan dan upah,serta biaya- biaya lain yang berhubungan dengan pelaksanaan bangunan atau proyek. Anggaran biaya merupakan harga dari bahan bangunan yang dihitung dengan teliti, cermat dan memenuhi syarat.

Dalam perhitungan Rencana Anggaran Biaya harus dihitung dengan teliti untuk penentuan keawetan dan kekuatan yang dipengaruhi oleh bahan bangunan yang digunakan. Isu seputar pemanasan global mendorong lahirnya bangunan berbasis hijau atau dikenal *green building* yang meminimumkan dampak negatif terhadap lingkungan dengan meningkatkan efisiensi penggunaan bahan, lahan, serta energy dalam proses pembangunan dan pengoperasian. Konsep hijau tak hanya memperhatikan komposisi luas lahan untuk penghijauan, juga material yang ramah lingkungan.

Pada pembangunan proyek gedung Ekonomi Akuntansi Fakultas Ekonomi Universitas Jember perlu adanya penanganan manajemen pengelolaan sumber daya proyek yang baik, karena itu perlu ditangani dengan perhitungan yang cermat dan teliti. Suatu proyek dikatakan baik jika penyelesaian proyek tersebut efisien ditinjau dari segi waktu, biaya dan mempertinggi efisiensi kerja baik manusia maupun alat.

Berdasarkan hasil pengolahan data dari proyek akhir ini disimpulkan bahwa Setelah dilakukannya survey harga material, upah pekerja pada tahun 2017 dan dilakukannya perhitungan volume dan analisa harga persatuan pekerjaan menurut aturan dari Dinas Tata Ruang dan Cipta Karya tahun 2017 maka dihitung Rencana Anggaran Biaya proyek gedung Ekonomi Akutansi Fakultas Ekonomi Universitas Jember senilai Rp 3.226.978.804,21 (Tiga Milyar Dua Ratus Dua Puluh Enam Juta Sembilan Ratus Tujuh Puluh Delapan Ribu Delapan Ratus Empat Koma Dua Puluh Satu Rupiah) RAB dan ditambahkan PPN sebesar 10 % dengan jumlah total anggaran adalah Rp 3.549.676.000,00 (Tiga Milyar Lima Ratus Empat Puluh Sembilan Juta Enam Ratus Tujuh Puluh Enam Ribu Rupiah)

PRAKATA

Puji syukur kehadiran Allah SWT atas segala rahmat dan karunia-Nya sehingga penulis dapat menyelesaikan proyek akhir yang berjudul "Perhitungan Rencana Anggaran Biaya Gedung Ekonomi Akuntansi Fakultas Ekonomi Universitas Jember". Laporan proyek akhir ini disusun untuk memenuhi salah satu syarat menyelesaikan pendidikan diploma tiga (DIII) pada Jurusan Teknik Sipil Fakultas Teknik Universitas Jember.

Penyusunan proyek akhir ini tidak lepas dari bantuan berbagai pihak, oleh karena itu, penulis menyampaikan terima kasih kepada:

1. Dekan Fakultas Teknik Universitas Jember Dr. Ir. Entin Hidayah, M.U.M atas kesempatan yang diberikan kepada penulis untuk menyelesaikan proyek akhir ini;
2. Ir. Hernu Suyoso, M.T. selaku Dosen Pembimbing Utama dan Dr. Anik Ratnaningsih, S.T., M.T. selaku Dosen Pembimbing Anggota yang penuh kesabaran memberi bimbingan, dorongan, meluangkan waktu, pikiran, perhatian dan saran kepada penulis selama penyusunan proyek akhir ini sehingga dapat terlaksana dengan baik;
3. Dr. Dewi Junita K, S.T., M.T. selaku Dosen Penguji I dan Anita Trisiana, S.T., M.T. selaku Dosen Penguji II, terima kasih atas saran dan kritiknya;
4. Seluruh Dosen Jurusan Teknik Mesin Fakultas Teknik Universitas Jember yang telah memberikan ilmu, bimbingan, pengorbanan, saran dan kritik kepada penulis;
5. Ibunda Ika Rusfiyati dan Ayahanda Arif Wijaya (Alm) yang telah memberikan segalanya kepada penulis;
6. Pihak lain yang tidak bisa disebutkan satu-persatu.

Penulis juga menerima segala kritik dan saran dari semua pihak demi kesempurnaan proyek akhir ini. Akhirnya penulis berharap, semoga tulisan ini dapat bermanfaat.

Jember, Desember 2017

Penulis



DAFTAR ISI

	Halaman
HALAMAN SAMPUL.....	i
HALAMAN JUDUL.....	ii
HALAMAN PERSEMBAHAN.....	iii
HALAMAN MOTTO.....	iv
HALAMAN PERNYATAAN.....	v
HALAMAN PEMBIMBING.....	vi
HALAMAN PENGESAHAN.....	vii
RINGKASAN.....	viii
KATA PENGANTAR.....	x
DAFTAR ISI.....	xii
DAFTAR GAMBAR.....	xv
DAFTAR TABEL.....	xvi
BAB I PENDAHULUAN.....	1
1.1 Latar Belakang.....	1
1.2 Rumusan Masalah.....	2
1.3 Batasan Masalah.....	2
1.4 Tujuan.....	2
1.5 Manfaat.....	2
BAB II TINJAUAN PUSTAKA.....	3
2.1 Estimasi Biaya Proyek.....	3
2.2 Perhitungan Biaya Pembangunan.....	3
2.2.1 Anggaran Biaya Kasar.....	4
2.2.2 Anggaran Biaya Rinci.....	4
2.3 Penjelasan Tahapan Pekerjaan.....	5
2.3.1 Pekerjaan Persiapan.....	5
2.3.2 Pekerjaan Tanah.....	6

2.3.3 Pekerjaan Pondasi.....	6
2.3.4 Pekerjaan Beton.....	7
2.3.5 Pekerjaan Dinding.....	7
2.3.6 Pekerjaan Kusen, Pintu, dan Jendela.....	8
2.3.7 Pekerjaan Rangka Atap.....	8
2.3.8 Pekerjaan Lantai dan Keramik.....	9
2.4 Menghitung Luas Bangunan.....	9
2.4.1 Batas Fisik.....	9
2.4.2 Ketentuan Bangunan.....	10
2.5 Volume Pekerjaan.....	10
2.6 Analisis Harga Satuan.....	11
BAB III METODOLOGI.....	12
3.1 Lingkup Penelitian.....	12
3.2 Lokasi Penelitian.....	12
3.3 Langkah-Langkah dalam Penelitian.....	13
3.3.1 Pengumpulan Data.....	13
3.3.2 Mempelajari Shop Drawing.....	14
3.3.3 Menghitung Luas Bangunan.....	14
3.3.4 Perhitungan Volume Pekerjaan.....	15
3.4 Survey Harga Material dan Upah Pekerja.....	16
3.5 Analisis Harga Satuan.....	16
3.6 Perhitungan Total Biaya.....	16
3.7 RAB Proyek.....	17
BAB IV HASIL DAN PEMBAHASAN.....	20
4.1 Data Umum Proyek.....	20
4.2 <i>Work Breakdown Structure</i>	20
4.3 Perhitungan Volume.....	34
4.3.1 Volume Pekerjaan Persipan.....	35
4.3.2 Volume Pekerjaan Tanah.....	35

4.3.3 Volume Pekerjaan Pondasi.....	36
4.3.4 Volume Pekerjaan Beton.....	38
4.4 Survey Harga Material dan Upah.....	42
4.5 Analisa Harga Satuan.....	43
4.5.1 Analisa Harga Satuan Pekerjaan Persiapan.....	43
4.5.2 Analisa Harga Satuan Pekerjaan Tanah.....	45
4.5.3 Analisa Harga Satuan Pekerjaan Pondasi.....	45
4.5.4 Analisa Harga Satuan Pekerjaan Beton.....	47
4.6 Rencana Anggaran Biaya Total Kegiatan.....	54
BAB V KESIMPULAN DAN SARAN.....	56
5.1 Kesimpulan.....	56
5.2 Saran.....	56
DAFTAR PUSTAKA.....	57
DAFTAR LAMPIRAN.....	58
1. Gambar Rencana.....	59
2. Volume Pekerjaan.....	93
3. Harga Material dan Upah Pekerja.....	134
4. Analisa Harga Satuan.....	144
5. Rencana Anggaran Biaya Seluruh Pekerjaan.....	271

DAFTAR TABEL

	Halaman
Tabel 4.1 Work Breakdown Structure.....	21
Tabel 4.2 Perhitungan Volume Pekerjaan Pondasi.....	37
Tabel 4.3 Analisa Harga Satuan Bahan Pekerjaan Persiapan Pasangan Bouwplank.....	43
Tabel 4.4 Analisa Harga Satuan Upah Pekerjaan Persiapan Pasangan Bouwplank.....	44
Tabel 4.5 Analisa Harga Satuan Pekerjaan Persiapan Pasangan Bouwplank.....	44
Tabel 4.6 Analisa Harga Satuan Pekerjaan Tanah Galian.....	45
Tabel 4.7 Analisa Harga Satuan Bahan Pekerjaan Pondasi Batu Belah.....	45
Tabel 4.8 Analisa Harga Satuan Upah Pekerjaan Pondasi Batu Belah.....	46
Tabel 4.9 Analisa Harga Satuan Pekerjaan Pondasi Batu Belah.....	46
Tabel 4.10 Analisa Harga Satuan Bahan Beton K275.....	47
Tabel 4.11 Analisa Harga Satuan Upah Beton K275.....	47
Tabel 4.12 Analisa Harga Satuan Beton K275.....	48
Tabel 4.13 Analisa Harga Satuan Bahan Pembesian.....	48
Tabel 4.14 Analisa Harga Satuan Upah Pembesian.....	49
Tabel 4.15 Analisa Harga Satuan Pembesian.....	49
Tabel 4.16 Analisa Harga Satuan Bahan Bekisting Kolom.....	50
Tabel 4.17 Analisa Harga Satuan Upah Bekisting Kolom.....	50
Tabel 4.18 Analisa Harga Satuan Pekerjaan Bekisting Untuk Kolom.....	51
Tabel 4.19 Analisa Harga Satuan Pekerjaan Kolom 40/60	51
Tabel 4.20 Analisa Harga Satuan Bahan Pekerjaan Bekisting Balok.....	52
Tabel 4.21 Analisa Harga Satuan Upah Pekerjaan Bekisting Balok.....	52
Tabel 4.22 Analisa Harga Satuan Bekisting Balok.....	53
Tabel 4.23 Analisa Harga Satuan Balok 20/40.....	53
Tabel 4.24 Rekapitulasi Anggaran Biaya Proyek.....	54

DAFTAR GAMBAR

	Halaman
Gambar 3.1 Lokasi Penelitian.....	13
Gambar 3.2 Flow chart Perhitungan Estimasi Biaya Proyek.....	18
Gambar 3.3 Diagram Alir Penelitian Tugas Akhir.....	19
Gambar 4.1 Denah Gedung Ekonomi Akuntansi Fakultas Ekonomi Universitas Jember.	35
Gambar 4.2 Pondasi Telapak.....	36
Gambar 4.3 Detail Pondasi Batu Kali.....	37
Gambar 4.4 Rencana Pondasi.....	38
Gambar 4.5 Kolom K1.....	39
Gambar 4.6 Type Kolom.....	39
Gambar 4.7 Rencana Kolom.....	40
Gambar 4.8 Balok.....	41
Gambar 4.9 Type Balok.....	41
Gambar 4.10 Rencana Balok.....	42

BAB 1.

PENDAHULUAN

1.1 Latar Belakang

Rencana Anggaran Biaya selalu berikatan dengan proses pembangunan proyek, rencana anggaran biaya akan dijadikan acuan untuk penjadwalan proyek, estimasi proyek, dan lain-lain. Maka dapat disimpulkan bahwa Rencana Anggaran Biaya adalah suatu perhitungan banyaknya biaya yang diperlukan untuk bahan dan upah,serta biaya- biaya lain yang berhubungan dengan pelaksanaan bangunan atau proyek. Anggaran biaya merupakan harga dari bahan bangunan yang dihitung dengan teliti, cermat dan memenuhi syarat.

Dalam perhitungan Rencana Anggaran Biaya harus dihitung dengan teliti untuk penentuan keawetan dan kekuatan yang dipengaruhi oleh bahan bangunan yang digunakan. Isu seputar pemanasan global mendorong lahirnya bangunan berbasis hijau atau dikenal *green building* yang meminimumkan dampak negatif terhadap lingkungan dengan meningkatkan efisiensi penggunaan bahan, lahan, serta energy dalam proses pembangunan dan pengoperasian. Konsep hijau tak hanya memperhatikan komposisi luas lahan untuk penghijauan, juga material yang ramah lingkungan.

Kriteria bahan bangunan ramah lingkungan yaitu mudah terurai secara alami dalam jangka waktu pendek, tidak mengandung bahan kimia beracun yang berbahaya bagi kesehatan dan lingkungan, dan dekat dengan alam yang artinya material berkesan alami.

Dalam proyek akhir ini direncanakan perhitungan rencana anggaran biaya dengan system analisa harga satuan yang memfokuskan dari survey harga material dan upah pekerja yang didapat di sekitar wilayah Kabupaten Jember. Penelitian ini bertujuan mengidentifikasi unsur biaya untuk merencanakan suatu kegiatan, yang terdiri dari biaya persiapan hingga finishing dan dari waktu mulai, waktu selesai dan waktu pelaporan.

Pada pembangunan proyek gedung Ekonomi Akutansi Fakultas Ekonomi Universitas Jember perlu adanya penanganan manajemen pengelolaan sumber daya proyek yang baik, karena itu perlu ditangani dengan perhitungan yang cermat dan teliti. Suatu proyek dikatakan baik jika penyelesaian proyek tersebut efisien ditinjau dari segi waktu, biaya dan mempertinggi efisiensi kerja baik manusia maupun alat.

1.2 Rumusan Masalah

Berdasarkan latar belakang diatas maka dapat dirumuskan permasalahan yaitu Berapa Rencana Anggaran Biaya proyek gedung Ekonomi Akutansi Fakultas Ekonomi Universitas Jember ?

1.3 Batasan Masalah

Dalam penulisan laporan tugas akhir ini, penulis membatasi penulisan pada beberapa masalah, yaitu :

1. Data proyek yang dianalisa adalah Proyek Pembangunan Gedung Ekonomi Akutansi Fakultas Ekonomi Universitas Jember yang diperoleh dari kontraktor yang menangani proyek.
2. Rencana Anggaran Biaya dilakukan berdasarkan analisa harga satuan yang diperoleh dari DPU Cipta Karya dan Tata Ruang tahun 2017 dengan dilakukan survey harga material, dan upah pekerja.
3. Gambar Rencana, Volume dan Spek Teknis diperoleh dari data proyek
4. Tidak menggunakan Kurva S.

1.4 Tujuan

Tujuan tugas akhir ini adalah Mengetahui Rencana Anggaran Biaya proyek gedung Ekonomi Akutansi Fakultas Ekonomi Universitas Jember.

1.5 Manfaat

Manfaat yang diharapkan dari penelitian ini adalah dari hasil penelitian dapat memberi informasi kepada pihak proyek tentang RAB proyek.

BAB 2.

TINJAUAN PUSTAKA

Pembangunan melibatkan banyak aktivitas. Tiap aktivitas memerlukan sejumlah biaya yang didefinisikan sebagai Rencana Anggaran Biaya. Rencana Anggaran Biaya adalah suatu perhitungan banyaknya biaya yang diperlukan untuk bahan dan upah, serta biaya-biaya lain yang berhubungan dengan pelaksanaan bangunan atau proyek. Anggaran biaya merupakan harga dari bahan bangunan yang dihitung dengan teliti, cermat dan memenuhi syarat.

2.1 Estimasi Biaya Proyek

Estimasi biaya adalah perkiraan atau perhitungan biaya pembangunan. Estimasi biaya disusun sebagai pedoman bagi pemilik untuk menyediakan dana dan sebagai pegangan pemilik proyek dalam pelaksanaan proyek (Istimawan Dipohusodo, 1999).

Dalam perhitungan estimasi biaya, perhatikan faktor resiko yang menyebabkan perubahan biaya, seperti kemungkinan naiknya harga material dan upah pekerja selama pelaksanaan, serta untuk bangunan bertingkat memerlukan peralatan khusus pengangkut material dan kecepatan waktu kerja yang berkurang.

Berikut keuntungan melakukan estimasi biaya sebelum pelaksanaan :

- a. Mengetahui jenis bahan yang akan digunakan dan dibeli.
- b. Mengetahui volume setiap bahan yang dibutuhkan.
- c. Perkiraan pengaturan keuangan berdasarkan jumlah biaya yang diperlukan
- d. Dapat mengontrol setiap pekerjaan yang sudah atau akan dilaksanakan
- e. Membantu sang pemilik bernegosiasi dalam penawaran harga kontraktor sehingga tidak merugikan pemilik.
- f. Menjadi pedoman bagi pemilik untuk menyediakan dana yang diperlukan

2.2 Perhitungan Biaya Pembangunan

Perhitungan biaya pembangunan dibagi menjadi anggaran biaya kasar dan anggaran biaya rinci, berikut penjelasan mengenai hal tersebut.

2.2.1 Anggaran Biaya Kasar

Penaksiran biaya kasar dilakukan dengan cara menghitung volume bangunan, harga satuan standar dari tipe bangunan, dan kualitas finishing bangunan. Contoh, luas bangunan 100 m² dengan standar bangunan kelas A @Rp. 1.500.000/m². Jadi asumsi biaya yang dibuat adalah mengalikan luas bangunan dengan harga satuan standar. Perkiraan biaya = 100 m² x Rp. 1.500.000,00/m² = Rp 150.000.000,00.

Perhitungan anggaran biaya kasar digunakan sebagai pedoman terhadap anggaran biaya yang dihitung secara rinci. Meski berupa pendekatan biaya kasar, tetapi hasil perhitungan antara anggaran biaya kasar dan rinci tidak jauh berbeda.

2.2.2 Anggaran Biaya Rinci

Anggaran biaya rinci adalah anggaran biaya bangunan yang dihitung secara mendetail, yaitu menghitung volume dan harga seluruh pekerjaan pelaksanaan. Volume dihitung berdasarkan gambar detail (bestek) yang dibuat perencana. Sementara itu, harga pekerjaan pelaksanaan ditentukan berdasarkan spesifikasi material yang dituangkan menjadi harga satuan pekerjaan

Harga satuan pekerjaan dihitung berdasarkan :

- a. Taksiran biaya material. Biasanya, harga material yang digunakan didapat dari harga material pasaran sekitar tempat pelaksanaan.
- b. Taksiran biaya pekerja. Biaya pekerja sangat dipengaruhi oleh panjangnya waktu kerja, keadaan tempat pekerjaan, dan keahlian pekerja.
- c. Taksiran biaya peralatan. Biaya peralatan yang diperlukan untuk suatu jenis konstruksi haruslah termasuk di dalam biaya operasional mesin dan peralatan tangan.

Berikut ini komponen pekerjaan dari tahap awal sampai penyelesaian pembangunan yang harus dihitung secara rinci :

- a. Pekerjaan persiapan. Terdiri dari pembersihan lahan, pengukuran, bouwplank, cut and fill, pagar pengaman, serta mobilisasi dan demobilisasi.
- b. Pekerjaan galian dan urukan.
- c. Pekerjaan struktur. Terdiri dari pondasi, sloof, kolom, balok, dinding, dan rangka penutup atap.

- d. Pekerjaan instalasi mekanikal, elektrikal, dan plumbing. Terdiri dari jaringan listrik, telepon, tata suara, tata udara, serta air bersih dan kotor.
- e. Pekerjaan luar/halaman. Terdiri dari jalan setapak, pengerasan jalan, taman, dan pagar halaman.

Setiap pekerjaan tersebut dibuat berdasarkan jenis material dan komponen pekerjaan, misalnya :

- a. Komponen beton dihitung berdasarkan volume (m³) dan dikalikan harga satuan permeter kubik (@Rp/M³)
- b. Komponen material lantai, dinding, dan plafon dihitung berdasarkan luas areal (m²) dikalikan harga satuan permeter persegi (@Rp/m²)
- c. Komponen pekerjaan finishing, seperti jaringan pipa, talang air, kabel, dan tali air dihitung berdasarkan panjang bahan (m) dikalikan harga satuan material permeter (@Rp/m²)
- d. Komponen material besar, seperti daun pintu, jendela, dan peralatan dihitung berdasarkan jumlah material yang digunakan (unit) dikalikan harga satuan material perunit (@Rp/unit). Bisa juga dengan perhitungan volume secara detail, yaitu kusen (m³), daun pintu (m²), kaca (m²), daun jendela (m²), dan material lain (bh), termasuk finishing.
- e. Komponen material yang sulit dihitung, tetapi harus dikerjakan dihitung dengan menentukan status lump sum (ls). Artinya, nilai besaran pekerjaan tersebut ditentukan berdasarkan cakupan pekerjaan yang dikerjakan sesuai kehendak perancang. Biasanya, komponen ini tidak memiliki harga satuan, tetapi langsung menyebutkan nilai total pekerjaan tersebut.

2.3 Penjelasan Tahapan Pekerjaan

Ada beberapa tahapan untuk menyelesaikan suatu proyek yaitu dimulai dengan pekerjaan persiapan, pekerjaan tanah, pekerjaan pondasi, pekerjaan beton, hingga pekerjaan finishing. Berikut penjelasannya.

2.3.1 Pekerjaan Persiapan

Pekerjaan persiapan merupakan tahapan awal pekerjaan proyek adapun tahapan pekerjaan persiapan yaitu :

- a. Pembersihan Lahan dihitung dengan cara lump sum

- b. Pengukuran adalah pekerjaan sebelum memulai pekerjaan konstruksi untuk menentukan posisi bangunan. Volume pengukuran dihitung dengan cara lump sum. Misal, pekerjaan diperkirakan 2 hari dengan 2 tukang (@ Rp 50.000/hari). Jadi, perhitungannya adalah $2 \times 2 \times \text{Rp } 50.000 = \text{Rp } 200.000$
- c. Umumnya, bouwplank menggunakan papan 2/15, dipaku pada kayu berukuran 6 x 7 m, volume bouwplank-nya adalah $(6+1+1) + (7+1+1) = 17 \text{ m}$. Sementara itu, untuk harga dan kebutuhan material dapat dilihat pada analisa pekerjaan

2.3.2 Pekerjaan Tanah

Setelah pekerjaan persiapan selesai dilanjutkan dengan pekerjaan tanah yang dibagi menjadi sebagai berikut beserta penjelasannya :

- a. Galian adalah pekerjaan menggali yang berhubungan dengan pembuatan pondasi. Kedalaman dan lebar galian ditentukan oleh pondasi. Misal, lebar bawah pondasi 70 cm, maka lebar galian 70 cm, ditambah lebar kiri-kanan masing-masing 10 cm. Jadi galian pondasi adalah $70+20 = 90 \text{ cm}$. Perhitungan volume galian (m^3) = $0,9 \text{ m} \times 0,7 \text{ m} \times \text{panjang pondasi}$.
- b. Urukan adalah pekerjaan menguruk lantai bangunan tertentu. Volume dihitung berdasarkan luas bangunan dikalikan tinggi urukan sehingga menghasilkan satuan m^3
- c. Menguruk kembali adalah pekerjaan menguruk bekas pondasi. Secara ringkas, volume bisa dihitung $1/3$ dari volume galian. Misal Volume galian 60 m^3 maka urukan kembali adalah $60 \text{ m}^3 / 3 = 20 \text{ m}^3$. Namun, dalam hitungan detail, volume urukan kembali dihitung dari volume galian dikurangi volume pondasi.

2.3.3 Pekerjaan Pondasi

Pekerjaan pondasi merupakan tahapan pekerjaan proyek yang meliputi pembuatan pondasi sendiri, berikut tahapan pekerjaan pondasi :

- a. Lantai kerja adalah pekerjaan dibawah pondasi. Lantai kerja dapat berupa urukan pasir setebal 10 cm atau beton dengan campuran 1:3:5 setebal 5-10 cm. Perhitungannya adalah luas dikalikan tebal dengan satuan m^3 .
- b. Pasangan pondasi. Pada umumnya, pondasi yang digunakan bangunan rumah satu lantai adalah pondasi batu kali. Volume didapat dengan menghitung luas penampang pondasi, yaitu tinggi pondasi dikalikan lebar atas dan bawah dibagi dua. Kemudian, dikalikan panjang pondasi. Misal, tinggi pondasi 0,7 m, lebar

atas 0,3 m, lebar bawah 0,7 m, dan panjang pondasi 50 m, maka volumenya adalah $0,7 \times ((0,3+0,7)/2) \times 50 = 17,5 \text{ m}^3$

2.3.4 Pekerjaan Beton

Pekerjaan Beton merupakan pekerjaan pembeconan dari pondasi hingga tahapan lainnya, berikut contoh dan proses perhitungan pekerjaan beton yang mengkerucut menjadi pekerjaan sloof, Sloof yaitu struktur bangunan yang berada diatas pondasi. Cara menghitung volumenya adalah :

- a. Volume beton = panjang sloof x lebar x tinggi = satuan m³
- b. Jumlah besi beton :

- Begel

Jumlah begel = panjang sloof / jarak baegel + 1. Panjang 1 begel = panjang total besi beton yang dibutuhkan. Misal, sloof 15/20, begel d 8-15, panjang total 25 meter. Jadi, Jumlah begel = $(25/0,15)+1=167,6 \text{ bh} = 168 \text{ bh}$

Panjang satu begel = $((15-5) \times 2) + ((20-5) \times 2) = 50 \text{ cm}$. Jadi total besi beton untuk begel adalah $0,5 \times 168 = 84 \text{ m}$. Panjang standar 1 batang besi beton = 12 m. Jadi diperlukan $84/12 = 7$ batang.

- Vesi beton tulsngsn pokok Jumlah tulangan pokok dikalikan panjang total. Dalam perhitungan anggaran biaya besi beton tidak ditampilkan merinci, tetapi hanya ditampilkan volume beton bertulang dengan besi sekian kg per m³ beton
- Kolom perhitungan volume beton sama seperti menghitung volume beton sloof. Perbedaannya terletak pada perhitungan bekisting. Bekisting kolom dihitung 4 sisi, sedangkan bekisting sloof dihitung 2 sisi.

2.3.5 Pekerjaan Dinding

Pekerjaan dinding dibagi menjadi beberapa pekerjaan, berikut tahapan mengenai pekerjaan dinding :

- a. Pasangan Bata

Terdapat dua cara menghitung volume pasangan bata, yaitu :

- Perhitungan luas. Hitung lebar dinding dikalikan tinggi dinding. Kemudian, dikurangi luas bagian bangunan yang mengurangi luas dinding, seperti jendela, pintu, dan bouven dalam satuan m².

- Perhitungan isi. Hitung luas dinding dikalikan tebal bata. Tebal bata tergantung jenis pasangan bata. Pasangan 1 bata = 30 cm, $\frac{1}{2}$ bata = 15 cm.
- b. Volume plesteran adalah 2 kali volume pasangan bata yang dihitung dengan cara perhitungan luas.
- c. Volume acian sama seperti menghitung volume plesteran dan dikurangi daerah tidak diaci seperti dinding keramik.
- d. Sponengan atau tali air adalah batas antara kusen dan plesteran. Jika lebar kusen dan plesteran. Jika lebar kusen kurang dari lebar dinding (15cm) maka batas antara kusen dan plesteran disebut sponengan. Sementara itu, jika lebar kusen sama dengan lebar dinding maka batas antara kusen dan plesteran disebut tali air.

2.3.6 Pekerjaan Kusen, Pintu, dan Jendela

Perhitungan kusen ada dua macam, yaitu :

- a. Satuan jadi (unit).
- b. Volume m³, yaitu dengan menghitung semua panjang dari bahan pembuat kusen, lalu dikalikan tebal dan lebar dari kayu.
- c. Terdapat beberapa macam daun pintu, seperti panil atau double plywood. Umumnya, perhitungan volume dengan satuan jadi (unit)

2.3.7 Pekerjaan Rangka Atap

Berikut tahapan mengenai pekerjaan atap :

- a. Kuda-kuda dihitung dengan satuan m³, yaitu panjang total kayu dikalikan dimensi kayu yang digunakan. Misal, panjang total bahan yang digunakan. Misal, panjang total bahan yang digunakan untuk kuda-kuda adalah 25 m dan kayu $\frac{8}{12}$ maka hitungan volumenya $25 \times 0,08 \times 0,12 = 0,24$ m³.
- b. Menghitung volume gording sama seperti volume kuda-kuda, satuannya adalah m³.
- c. Menghitung jurai sama seperti perhitungan gording.
- d. Menghitung balok nok sak sama seperti gording.
- e. Pemasangan kuda-kuda tidak membutuhkan material tambahan karena kuda-kuda dipasang diatas setelah dibuat terlebih dahulu dibawah. Biasanya, biaya dikurangi 50 persen dari biaya pembuatan kuda-kuda.

- f. Pasang papan suri, yaitu papan yang terletak diatas balok nok dan berfungsi untuk menahan kerpus. Ukuran yang digunakan biasanya $2/20$. Satuan volumenya meter.
- g. Biasanya pemasangan usuk menggunakan kayu berukuran $5/7$ untuk atap genting. Untuk atap asbes atau seng tidak memerlukan usuk, cukup dengan gording.
- h. Terdapat dua macam ukuran reng, yaitu $2/3$ dan $3/4$. Perhitungan reng sama seperti menghitung usuk.
- i. Ada beberapa jenis genting seperti genteng beton dan keramik.
- j. Jenis bahan talang yang umum digunakan, seperti talang seng, PVC, dan beton. Untuk setiap jenis bahan, cara perhitungan volumenya berbeda.
- k. Jenis bahan list plank yang umum digunakan, yaitu bahan kayu, beton, PVC, Fiber. Saat ini, List plank yang sering digunakan terbuat dari kayu dan beton. Perhitungan volumenya tidak mengikat.

2.3.8 Pekerjaan Lantai dan Keramik

Pekerjaan lantai keramik dibagi menjadi :

- a. Lantai kerja 1 PC ;3, yaitu floor atau plesteran lantai, tebal beton lantai untuk rumah tinggal 5-10 cm. Sebelum lantai dipelester, sebaiknya diberi urukan pasir setebal 10 cm. Untuk perhitungan volume lantai beton adalah m^3 .
- b. Pasang keramik lantai utama dan wc. Pemasangan keramik lantai volume yang digunakan adalah luas dengan satuan m^2 .
- c. Pasang keramik dinding. Pemasangan keramik dinding volumenya yang digunakan adalah luas dengan satuan m^2 .

2.4 Menghitung Luas Bangunan

Menghitung Luas bangunan dihitung dengan tahapan batas disik dan lain-lain yang dijelaskan seperti dibawah ini.

2.4.1 Batas Fisik

Sebidang tanah, selain memiliki batas-batas daerah yang boleh dan tidak boleh dibangun (Garis Sempadan Bangunan/GSB) juga mempunyai ketentuan lain dari keberadaan lokasi tanah tersebut. Semua ditentukan berdasarkan perbandingan luas bangunan dan halaman yang berbeda-beda (Irika Widiasanti, 2014).

Jika kita mengenal ketentuan KDB (Koefisien Dasar Bangunan), misalnya 60 %, maka sebenarnya anda tidak diijinkan membangun sekitar 60% dari luas bangunan pasalnya, 40 % luas bangunan harus berupa halaman terbuka. Dengan demikian, untuk mengetahui apakah luas bangunan memenuhi KDB atau tidak, hitung luas bangunan sebelum memulai pelaksanaan.

2.4.2 Ketentuan Bangunan

Hal yang harus diketahui sebelum membangun bangunan :

- a. Dalam menghitung jumlah luas lantai suatu ruang, perhitungan dilakukan sampai batas dinding terluar. Jika ada ruang berhimpitan dan dibatasi dinding, perhitungannya adalah dari as (tengah-tengah) dinding sampai dinding berikutnya.
- b. Ruangan tertutup atap yang dindingnya lebih tinggi 1,2 m2 dari lantai atas, dihitung penuh. Misal, ruang berukuran 3x4 m2, maka luasnya adalah 12 m2. Jika dinding pembatas ruang tingginya kurang dari 1,2 m2, maka luas ruang tersebut hanya dihitung separuh.
- c. Overstek, seperti balkon berdinding tidak lebih dari 1,2 m2, tidak diperhitungkan luasnya.
- d. Teras beratap dengan sebagian dindingnya lebih dari 1,2 m2, diperhitungkan 60%. Sementara itu, untuk ruang bawah tanah, luas tanah dihitung penuh.

2.5 Volume Pekerjaan

Menghitung volume pekerjaan sangatlah mudah karena menggunakan prinsip dasar matematika yaitu :

- a. Menghitung volume dengan satuan meter kubik (m³), missal satuan pekerjaan pasangan kolom. Volume dihitung berdasarkan perkalian antara luas penampang kolom dan tinggi kolom keseluruhan.

$$Plt = \text{Panjang} \times \text{Lebar} \times \text{Tinggi} \times 1 \text{ M}^3 \dots \dots \dots (1)$$

- b. Menghitung volume dengan satuan meter persegi (m²), missal satuan pekerjaan plesteran volume dihitung berdasarkan perkalian lebar dan panjang permukaan, serta tinggi dinding.

$$Pl \text{ atau } Pt = (\text{Panjang} \times \text{Lebar} \text{ atau } \text{Panjang} \times \text{Tinggi}) \times 1 \text{ m}^2 \dots \dots \dots (2)$$

- c. Mengitung volume dengan satuan meter (m), missal satuan pekerjaan list plafons. Volume dihitung berdasarkan panjang keseluruhan atau keliling ruangan yang dipasang list plafon.

$$L = \text{Panjang} \times 1\text{m}' \dots\dots\dots (3)$$

- d. Menghitung volume dengan satuan buah (bh), missal volume pemasangan titik lampu. Volume dihitung berdasarkan jumlah keseluruhan titik lampu. Untuk membantu mempermudah perhitungan volume, sangat diwajibkan mengetahui rumus-rumus bangun datar dan bangun ruang.

$$\text{Bangun datar} = \text{Panjang} \times \text{Lebar} \dots\dots\dots (4)$$

$$\text{Bangun Ruang} = \text{Panjang} \times \text{Lebar} \times \text{Tinggi} \dots\dots\dots (5)$$

Perhitungan volume pekerjaan atas semua item pekerjaan, mulai dari pembersihan lahan, pekerjaan galian, timbunan, tembok dan beton, kayu, atap, plafon, lantai, pengecatan, kaca, engsel dan kunci, sanitasi, serta instalasi.

2.6 Analisis Harga Satuan

Analisis harga satuan merupakan pedoman memnentukan harga satuan pekerjaan konstruksi suatu bangunan (Ronny Abdillah, 2014). Di dalamnya, terdapat angka koefisien yang berfungsi sebagai dasar awal perhitungan (RAB) suatu bangunan. Setiap Koefisien berbeda, tergantung daerah atau lokasi pembangunan.

Penentuan koefisien sendiri menurut pengalaman atau penelitian langsung lapangan. Caranya dengan melihat dan meneliti kebutuhan bahan, waktu, dan tenaga pada suatu pekerjaan yang akan dilaksanakan. Cara tersebut terbilang efisieen, tetapi membutuhkan waktu cukup banyak. Namun , hasil yang didapat akan mendekati ketepatan karena diambil langsung dari pengalaman saat pelaksanaan pembangunan.

Faktot koefisien yang dibutuhkan adalah tenaga, bahan atau material, dan perlatan. Misal, dalam penyelesaian pekerjaan pasangan bata setiap meter persegi membutuhkan berapa banyak tenaga, material, dan peralatan. Nilai koefisien itu jika dikalikan harga stauan setiap unit material atau tenaga maka akan keluar harga satuan setiap item pekerjaan.

BAB III.

METODOLOGI

Dalam penelitian ini, metodologi penelitian digunakan untuk pedoman penelitian agar dalam proses pengerjaannya bisa runtut dan sistematis. Yang digunakan adalah metode kualitatif dimana penelitian tentang riset yang bersifat deskriptif dan cenderung menggunakan analisis. Landasan teori digunakan agar fokus penelitian sesuai dengan kondisi dilapangan.

3.1 Lingkup Penelitian

Penelitian ini adalah Rencana Anggaran Biaya pengembangan proyek pembangunan Gedung Ekonomi Akutansi Fakultas Ekonomi Universitas Jember. Penelitian yang dilakukan adalah merencanakan Rencana Anggaran Biaya berdasarkan proyek pembangunan gedung Ekonomi Akutansi Fakultas Ekonomi Universitas Jember.

3.2 Lokasi Penelitian

Berdasarkan Gambar 1 penelitian ini dilakukan di Jalan Kalimantan, Sumber sari, jember, Jawa Timur. Dengan lahan ditunjukkan oleh garis merah yang menjadi batas lahan pembangunan.

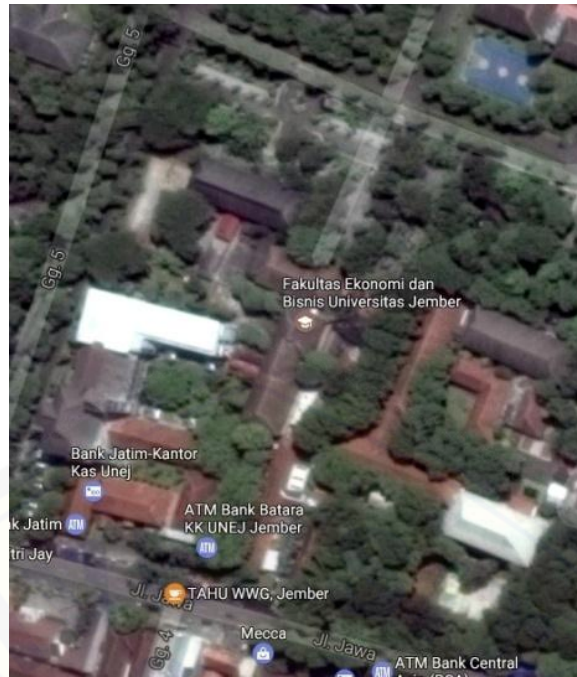

Gambar 3.1 Lokasi Pembangunan Proyek Gedung Ekonomi Akuntansi Fakultas Ekonomi Universitas Jember.

Data yang diperoleh dalam proyek ini adalah data sekunder yang didapat pada data yang ada pada proyek. Data sekunder adalah data yang diambil secara tidak langsung. Data sekunder ini diambil melalui data-data proyek, laporan-laporan proyek, dan buku-buku literature yang umumnya berupa teori, informasi, konsep dasar atau metode-metode yang dapat menunjang ataupun mendukung penulisan tugas akhir ini, seperti time schedule maupun data-data pendukung lainnya.

3.3 Langkah-Langkah Dalam Penelitian

Adapun langkah-langkah dalam penelitian ini adalah untuk beberapa tahapan yang dijelaskan seperti dibawah ini.

3.3.1 Pengumpulan Data

Data yang diperoleh dalam proyek akhir ini adalah data primer dan sekunder Adapun data primer yang didapat yaitu data yang diambil secara langsung, yaitu daftar harga material dan upah pekerja sedangkan data sekunder yang diperoleh yaitu data yang diambil melalui data-data proyek, gambar rencana, laporan-laporan proyek,

Bill of Quantity, dan *Time Schedule*. konsep dasar atau metode-metode yang dapat menunjang ataupun mendukung penulisan tugas akhir ini.

Untuk mendapatkan RAB pada proyek gedung Ekonomi Akutansi Fakultas Ekonomi Universitas Jember dibutuhkan beberapa data yakni *Bill of Quantity* (BQ), gambar rencana proyek dan data pendukung lainnya.

3.3.2 Mempelajari *Shop Drawing*

Setelah mendapatkan data-data proyek gedung Ekonomi Akutansi Fakultas Ekonomi Universitas Jember, maka data harus diolah. Berikut ini adalah runtutan pengolahan data yang diperoleh dan mempelajari *Shop Drawing*

Cara mempelajari gambar yaitu :

- a. Membaca bentuk bangunan pada gambar
- b. Membaca ukuran bangunan.
- c. Membaca skala gambar.
- d. Membaca symbol gambar.
- e. Membaca Keterangan jenis material bangunan.
- f. Membaca RKS
- g. Membuat Spek Teknis Bangunan

3.3.3 Menghitung Luas Bangunan

Menghitung luas bangunan proyek dibagi menjadi dua cara yang dijabarkan seperti dibawah ini.

- a. Batas Fisik

Sebidang tanah, selain memiliki batas-batas daerah yang boleh dan tidak boleh dibangun (*Garis sempadan bangunan/GSB*) juga mempunyai ketentuan lain dari keberadaan lokasi tanah tersebut. Semua ditentukan berdasarkan perbandingan luas bangunan dan halaman yang berbeda-beda.

Jika kita mengenal ketentuan KDB (*Koefisien Dasar Bangunan*), misalnya 60 % , maka sebenarnya tidak diijinkan membangun sekitar 60% dari luas bangunan.

Pasalnya, 40 % luas bangunan harus berupa halaman terbuka. Dengan demikian, untuk mengetahui apakah luas bangunan memenuhi KDB atau tidak.

b. Ketentuan Bangunan

Dalam menghitung jumlah luas lantai suatu ruang, perhitungan dilakukan sampai batas dinding terluar. Jika ada ruang berhimpitan dan dibatasi dinding, perhitungannya as (tengah-tengah) dinding sampai dinding berikutnya

Ruangan tertutup atap yang dindingnya lebih tinggi dari 1,20 m² dari lantai atas dihitung penuh. Misal, ruang berukuran 3x4 m², maka luasnya adalah 12 m². Jika dinding pembatas ruang tingginya kurang dari 1,20 m², maka luas ruang tersebut hanya dihitung separuh. Overstek, seperti balkon berdinding tidak lebih dari 1,20 m², tidak diperhitungkan luasnya.

Teras beratap dengan sebagian dindingnya lebih dari 1,20m², diperhitungkan 60 %. Sementara itu, untuk ruang bawah tanah, luas tanah dihitung penuh.

3.3.4 Perhitungan volume pekerjaan

Cara menghitung volume pekerjaan sangatlah mudah karena hanya menggunakan prinsip matematika dasar yang semua orang pasti kuasai yaitu penjumlahan, pengurangan, perkalian dan pembagian, misalkan :

Menghitung volume dengan satuan kubik (m³), misalkan satuan pekerjaan pasangan pondasi batu kali. Volume dihitung berdasarkan perkalian antara luas penampang pondasi dengan panjang pondasi keseluruhan.

Menghitung volume dengan satuan luas (m²), misalkan satuan pekerjaan pengecatan. Volume dihitung berdasarkan perkalian lebar / panjang permukaan yang akan dicat dengan tinggi permukaan tersebut.

Menghitung volume dengan satuan meter (m), misalkan satuan pekerjaan list plafond. Volume dihitung berdasarkan panjang keseluruhan list plafond atau keliling ruangan yang dipasang list plafond.

Menghitung volume dengan satuan buah (bh), misalkan volume pemasangan stop kontak. Volume dihitung berdasarkan jumlah keseluruhan stop kontak yang dipasang.

3.4 Survey Harga Material dan Upah Pekerja

Survey harga material dan upah pekerja sangatlah penting karena dua hal tersebut akan mempengaruhi keuntungan ataupun kerugian. Sehingga kontraktor harus teliti dalam memasukan harga material ataupun upah pekerja.

Pada penelitian ini survey harga material dan upah pekerja dilakukan diwilayah Kabupaten Jember, sehingga RAB awal terdapat perbandingan dengan RAB yang baru.

3.5 Analisis Harga Satuan

Analisis harga satuan merupakan pedoman menentukan harga satuan pekerjaan kontruksi suatu bangunan. Didalamnya, terdapat angka koefisien yang berfungsi sebagai dasar awal perhitungan Rencana Anggaran Biaya (RAB) suatu bangunan. Setiap koefisien berbeda tergantung daerah atau lokasi pembangunan dalam proyek akhir ini menggunakan Analisa Harga Satuan dari Dinas Pekerjaan Umum Cipta Karya dan Tata Ruang tahun 2017.

Untuk menentukan koefisien sendiri caranya dengan melihat dan meneliti kebutuhan bahan, waktu, dan tenaga pada suatu pekerjaan yang akan dilaksanakan. Cara tersebut terbilang lebih efisien, tetapi membutuhkan waktu cukup banyak. Namun, hasil yang didapat akan mendekati ketepatan karena diambil langsung dari pengalaman saat pelaksanaan pembangunan.

Faktor koefisien yang dibutuhkan adalah tenaga, bahan atau material, dan peralatan. Misal, dalam penyelesaian pekerjaan pasangan bata setiap meter persegi membutuhkan berapa banyak tenaga, material dan peralatan. Nilai koefisien itu jika dikalikan harga satuan setiap unit material atau tenaga maka akan keluar harga satuan setiap item pekerjaan.

3.6 Perhitungan Total Biaya

Perhitungan total biaya proyek diperoleh dari analisa harga satuan dikalikan dengan volume proyek yang sudah didapatkan pada tahapan sebelumnya. Setelah diperoleh jumlah anggaran yang diperlukan dalam setiap pekerjaan maka dijumlahkan

total jumlah anggaran yang diperlukan dan ditemukanlah Total anggaran biaya yang dibutuhkan.

3.7 RAB Proyek

RAB Proyek merupakan rekapitulasi dari perhitungan total biaya yang didapat pada tahapan sebelumnya ditambahkan dengan jumlah Ppn 10% lalu dibulatkan .



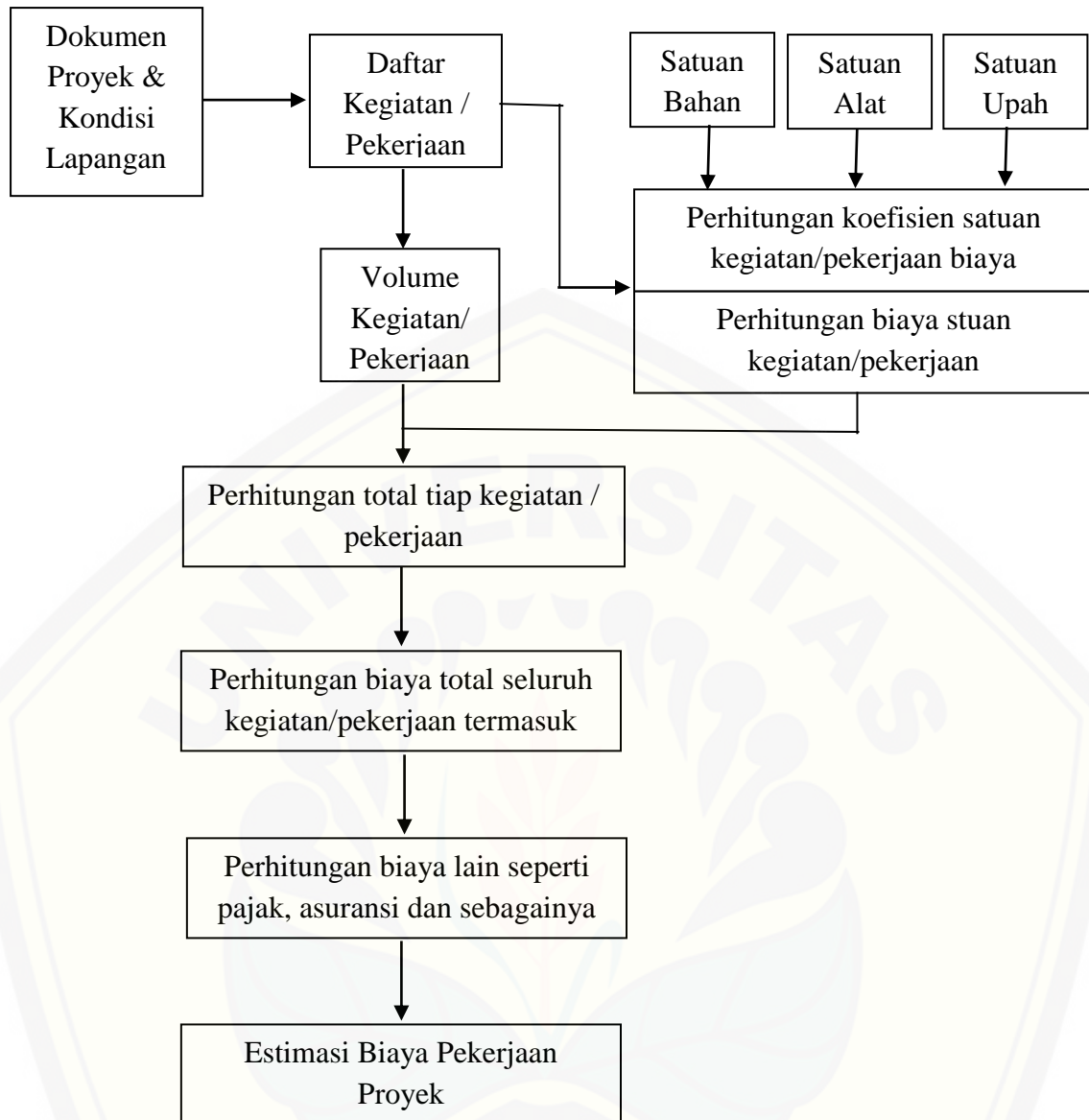

Gambar 3.2 Flow Chart Perhitungan Estimasi Biaya Proyek

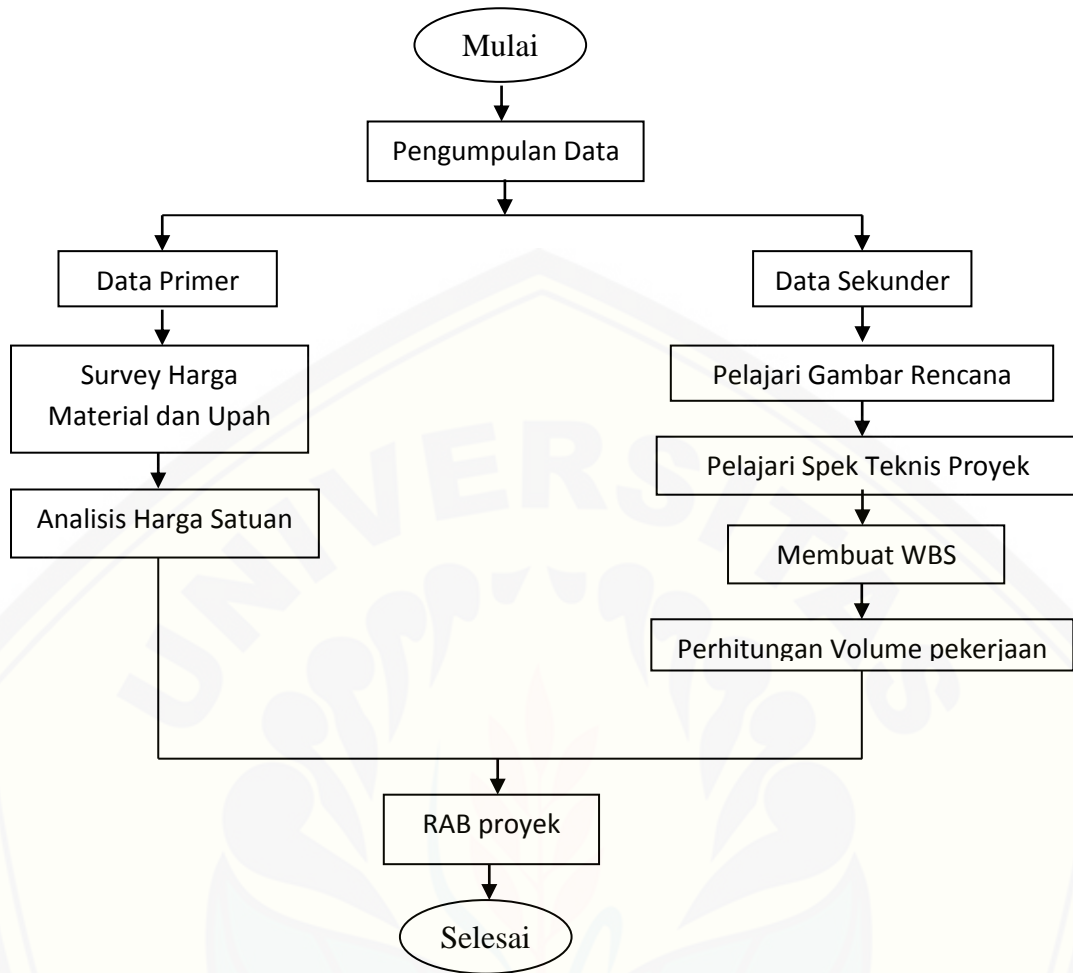

Gambar 3.3 Diagram Alir Penelitian Tugas Akhir

BAB V

KESIMPULAN DAN SARAN

5.1 Kesimpulan

Berdasarkan hasil pengolahan data dari proyek akhir ini disimpulkan bahwa Setelah dilakukannya survey harga material, upah pekerja pada tahun 2017 dan dilakukannya perhitungan volume dan analisa harga persatuan pekerjaan menurut aturan dari Dinas Tata Ruang dan Cipta Karya tahun 2017 maka dihitung Rencana Anggaran Biaya proyek gedung Ekonomi Akutansi Fakultas Ekonomi Universitas Jember senilai Rp 3.226.978.804,21 (Tiga Milyar Dua Ratus Dua Puluh Enam Juta Sembilan Ratus Tujuh Puluh Delapan Ribu Delapan Ratus Empat Koma Dua Puluh Satu Rupiah) RAB dan ditambahkan PPN sebesar 10 % dengan jumlah total anggaran adalah Rp 3.549.676.000,00 (Tiga Milyar Lima Ratus Empat Puluh Sembilan Juta Enam Ratus Tujuh Puluh Enam Ribu Rupiah)

5.2 Saran

Adapun saran untuk penelitian selanjutnya adalah :

1. Kesempurnaan dalam perhitungan anggaran biaya sebaiknya juga memasukan unsur resiko dalam setiap kegiatan agar dapat diketahui secara pasti jumlah anggaran yang dibutuhkan terutama pembangunan gedung.
2. Perhitungan Rencana Anggaran Biaya harus tahu memposisikan dirinya sebagai estimator proyek atau kontraktor proyek.

DAFTAR PUSTAKA

- Clifford Gray dan Erik Larson. 2007. *Manajemen Proyek Proses Manajerial*. Andi Offset :Yogyakarta
- H. Bachtiar Ibrahim. 2001. *Rencana dan Estimate Real of Cost*. PTb Bumi Aksara : Jakarta
- Irika Widiasanti dan Lenggogeni. 2013. *Manajemen Kontruksi*. Remaja Rosdakarya Offset : Jakarta
- Ronny Abdillah dan Irika Widiasanti. 2014. *Cara Cepat Merencanakan dan Menghitung RAB*. Kenaya Press : Jakarta
- Soeharto, Imam. 1999. *Manajemen Proyek : Dari Konseptual sampai Operasional*. Erlangga : Jakarta
- Wulfram, I. Ervianto. 2002. *Teori Aplikasi Manajemen Proyek Kontruksi*. Andi offset : Yogyakarta

DAFTAR LAMPIRAN

	Halaman
1. Gambar Rencana Proyek.....	59
2. Volume Pekerjaan.....	93
3. Survey Harga Material dan Upah Pekerja.....	134
4. Analisa Harga Satuan.....	144
5. Rencana Anggaran Biaya Proyek.....	271

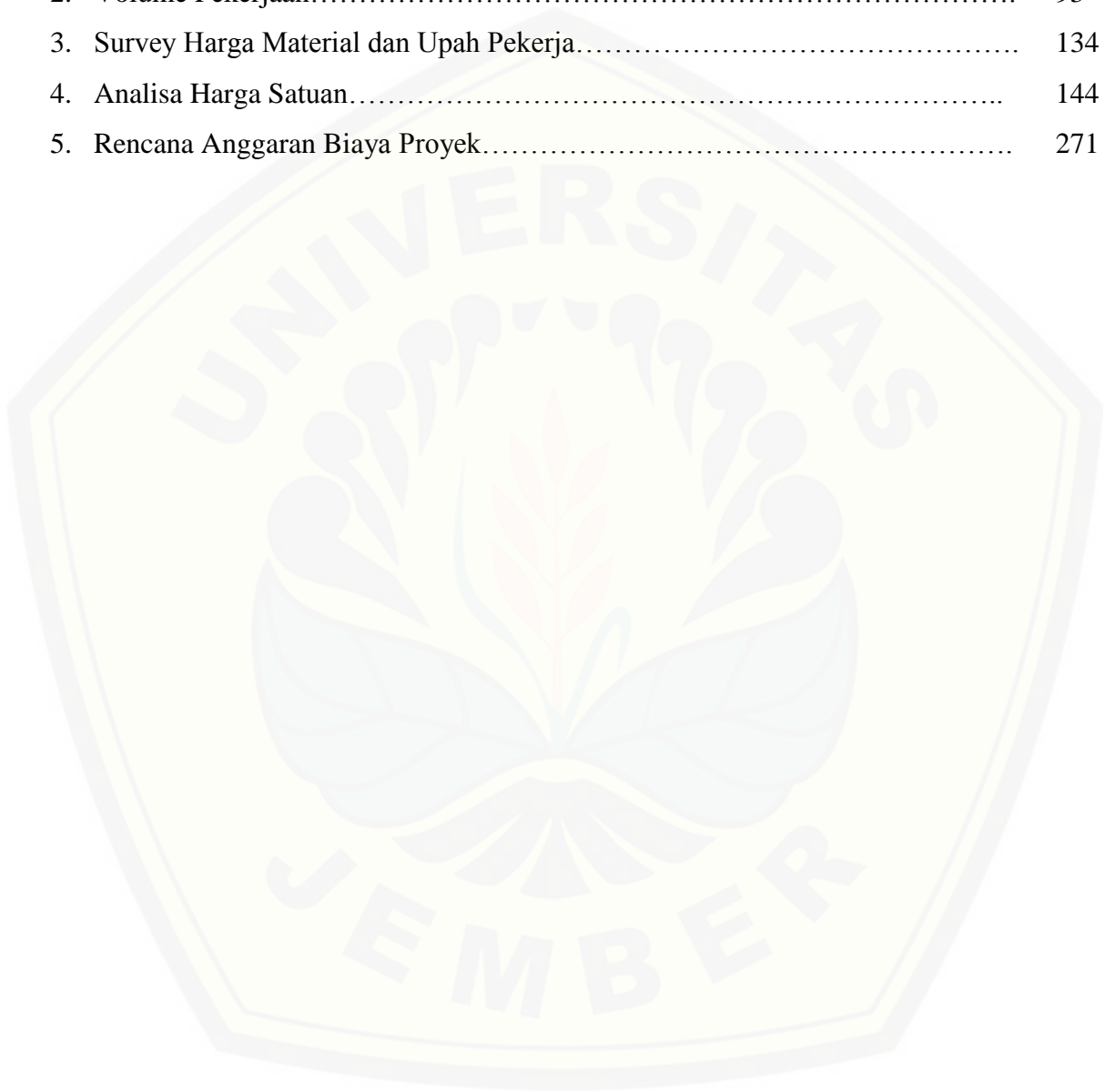

1. Gambar Rencana Proyek



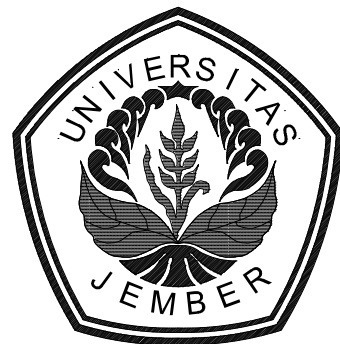

**KEMENTERIAN RISET, TEKNOLOGI
DAN PENDIDIKAN TINGGI
UNIVERSITAS JEMBER**

**Jl. Kalimantan no. 37 Kampus Tegal Boto Kotak Pos 159
Telp. (0331) 32445, 324446 Fax (0331) - 339029, 337422
JEMBER**

GAMBAR PERENCANAAN

KEGIATAN :

**SARANA / PRASARANA
PENDUKUNG PEMBELAJARAN**

PEKERJAAN :

**PEMBANGUNAN GEDUNG AKUNTANSI FAKULTAS EKONOMI
(TAHAP 1)**

LOKASI :

UNIVERSITAS JEMBER

TAHUN ANGGARAN 2016



Architect - Planner - Construction - Consultant

PT. DEWI PERMATA MANDIRI

Kantor : Jl. Langsep Raya No. 02A / 08 Tlp. (0331) 424080 Jember 68111

. Perencana - Perancang - Pengawas & Manajemen Konstruksi .



**GAMBAR STRUKTUR
(STR)**

DAFTAR GAMBAR

PEKERJAAN :
PEMBANGUNAN GEDUNG AKUNTANSI FAKULTAS EKONOMI
(TAHAP 1)

NO	JUDUL GAMBAR	KODE	NOMER GAMBAR
	STUKTUR		
1	RENCANA DAN DETAIL PONDASI	STR	01 - 03
2	KEYPLAN KOLOM	STR	04 - 05
3	KEYPLAN BALOK	STR	06 - 08
4	RENCANA PLAT LANTAI	STR	09 - 11
5	RENCANA ATAP	STR	12 - 15
6	TABEL BETON	STR	16 - 17
7	RENCANA PORTAL AS HURUF	STR	18 - 22
8	RENCANA PORTAL AS ANGKA	STR	23 - 27
9	DETAIL TANGGA	STR	28 & 31



KEMENTERIAN RISET, TEKNOLOGI DAN PENDIDIKAN TINGGI
UNIVERSITAS JEMBER
 Jl. Kalimantan no. 37 Kampus Tegol Boto Kotak Pos 159
 Telp. (0331) 32445, 32446 Fax (0331) - 339029, 337422
JEMBER



BANGUNAN YANG DI BONGKAR

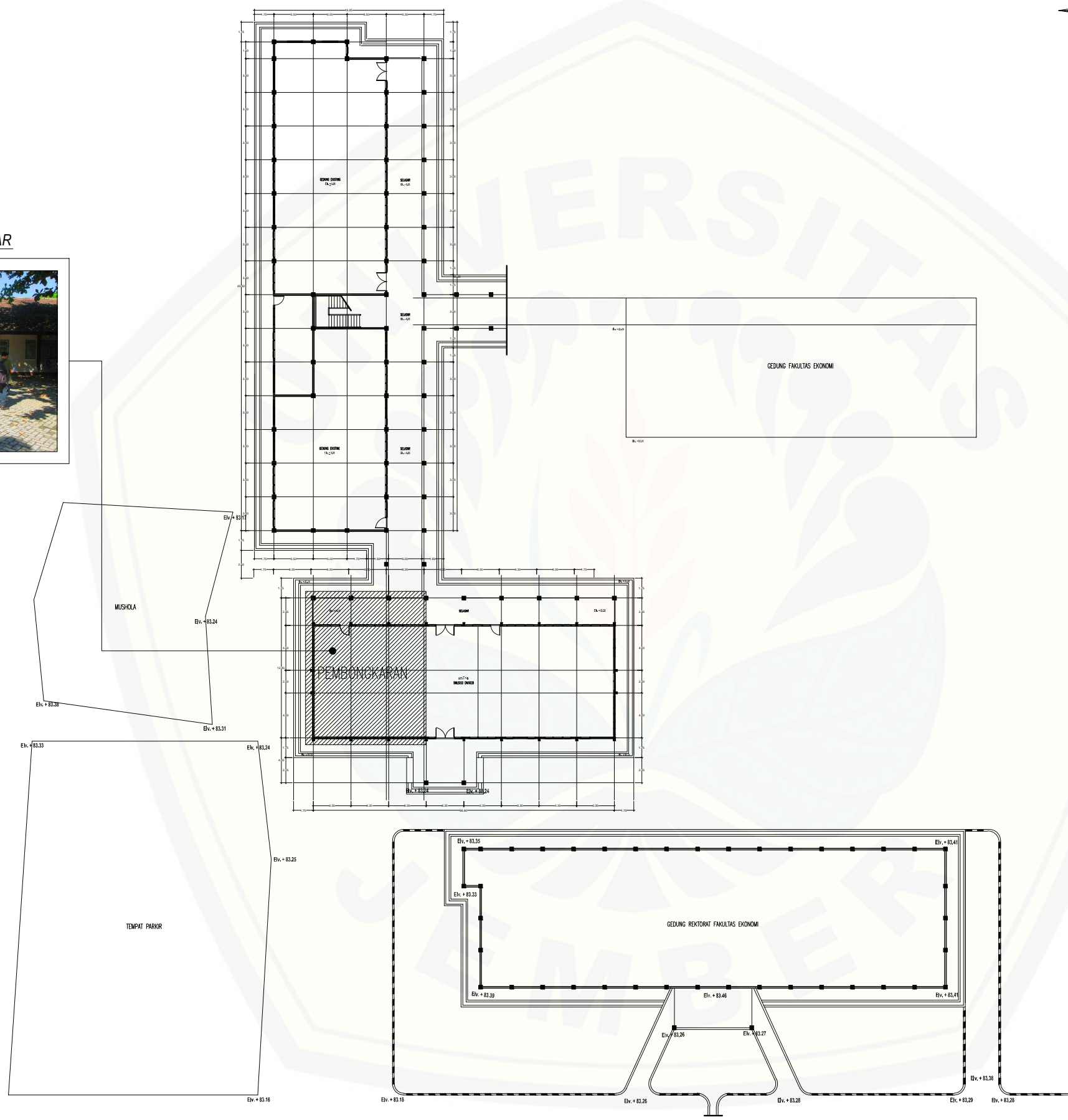

LAYOUT
 SKALA 1 : 400

KEGIATAN		
SARANA / PRASARANA PENDUKUNG PEMBELAJARAN		
PEKERJAAN		
PEMBANGUNAN GEDUNG AKUNTANSI FAKULTAS EKONOMI (TAHAP 2)		
LOKASI		
UNIVERSITAS JEMBER		
MENGETAHUI / MENYETUJUI	TGL	TANDA TANGAN
PEMBANTU REKTOR II UNIVERSITAS JEMBER DR. AKHMAD TOHA, M.Si. NIP. 19571227 198702 1 002		
MENGETAHUI / MENYETUJUI	TGL	TANDA TANGAN
PEJABAT PEMBUAT KOMITMEN UNIVERSITAS JEMBER BADERUN, SE NIP. 19630215 198703 1 002		
MENGETAHUI / MENYETUJUI	TGL	TANDA TANGAN
KEPALA BIRO III UNIVERSITAS JEMBER Drs. SUGIARTO, S.H., M.M. NIP. 19591220 198003 1 001		
MENGETAHUI / MENYETUJUI	TGL	TANDA TANGAN
DEKAN FAKULTAS EKONOMI UNIVERSITAS JEMBER DR. M. FATHORRAZI, M.Si. NIP. 196306 14199002 1 001		
MENGETAHUI / MENYETUJUI	TGL	TANDA TANGAN
KETUA TIM TEKNIS Ir. HERNU SUYOSO, M.T. NIP. 19551112 198702 1 001		
KONSULTAN PERENCANA		
Architect - Planner - Construction - Consultant PT. DEWI PERMATA MANDIRI Kantor : Jl. Langsep Raya No. 02A / 08 Tlp. (0331) 424080 Jember 68111 . Perencana - Perancang - Pengawas & Manajemen Konstruksi .		
DIGAMBAR	DIPERIKSA	PENANGGUNG JAWAB GAMBAR
DIMAS SAHRUL A. DRAFTER	DIAN PRAMITASARI, ST. TENAGA AHLI ARSITEKTUR	Ir. SRIWIYONO DIREKTUR UTAMA
JUDUL GAMBAR		SKALA
LAYOUT		1 : 400
KODE GAMBAR	NOMOR LEMBAR	JUMLAH LEMBAR
ARS	I	02



KEMENTERIAN RISET, TEKNOLOGI DAN PENDIDIKAN TINGGI
UNIVERSITAS JEMBER
 Jl. Kalimantan no. 37 Kampus Tegol Boto Kotak Pos 159
 Telp. (0331) 32445, 324446 Fax (0331) - 339029, 337422
JEMBER



RENCANA PEMBANGUNAN GEDUNG AKUNTANSI

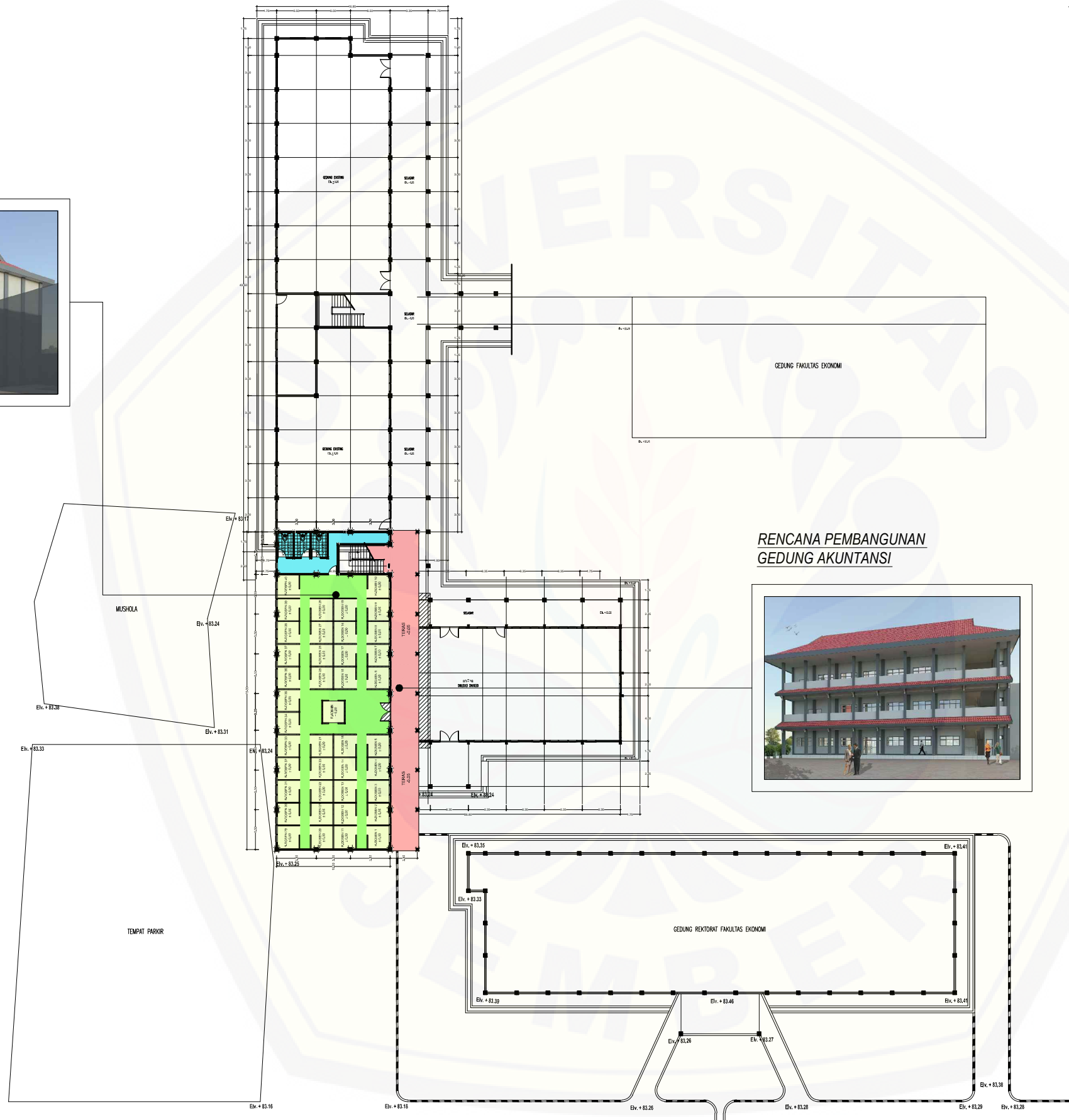

RENCANA PEMBANGUNAN GEDUNG AKUNTANSI



SITEPLAN
 SKALA 1 : 400

KEGIATAN		
SARANA / PRASARANA PENDUKUNG PEMBELAJARAN		
PEKERJAAN		
PEMBANGUNAN GEDUNG AKUNTANSI FAKULTAS EKONOMI (TAHAP 2)		
LOKASI		
UNIVERSITAS JEMBER		
MENGETAHUI / MENYETUJUI	TGL	TANDA TANGAN
PEMBANTU REKTOR II UNIVERSITAS JEMBER DR. AKHMAD TOHA, M.Si. NIP. 19571227 198703 1 002		
MENGETAHUI / MENYETUJUI	TGL	TANDA TANGAN
PEJABAT PEMBUAT KOMITMEN UNIVERSITAS JEMBER BADERUN, SE NIP. 19630215 198703 1 002		
MENGETAHUI / MENYETUJUI	TGL	TANDA TANGAN
KEPALA BIRO III UNIVERSITAS JEMBER Drs. SUGIARTO, S.H., M.M. NIP. 19591220 198003 1 001		
MENGETAHUI / MENYETUJUI	TGL	TANDA TANGAN
DEKAN FAKULTAS EKONOMI UNIVERSITAS JEMBER DR. M. FATHORRAZI, M.Si. NIP. 196306 14199002 1 001		
MENGETAHUI / MENYETUJUI	TGL	TANDA TANGAN
KETUA TIM TEKNIS Ir. HERNU SUYOSO, M.T. NIP. 19551112 198702 1 001		

KONSULTAN PERENCANA
 Architect - Planner - Construction - Consultant
PT. DEWI PERMATA MANDIRI
 Kantor : Jl. Langsep Raya No. 02A / 08 Tlp. (0331) 424080 Jember 68111
 . Perencana - Perancang - Pengawas & Manajemen Konstruksi .

DIGAMBAR	DIPERIKSA	PENANGGUNG JAWAB GAMBAR
DIMAS SAHRUL A. DRAFTER	DIAN PRAMITASARI, ST. TENAGA AHLI ARSITEKTUR	Ir. SRIWIYONO DIREKTUR UTAMA
JUDUL GAMBAR		SKALA
SITEPLAN		1 : 400
KODE GAMBAR	NOMOR LEMBAR	JUMLAH LEMBAR
ARS	II	02

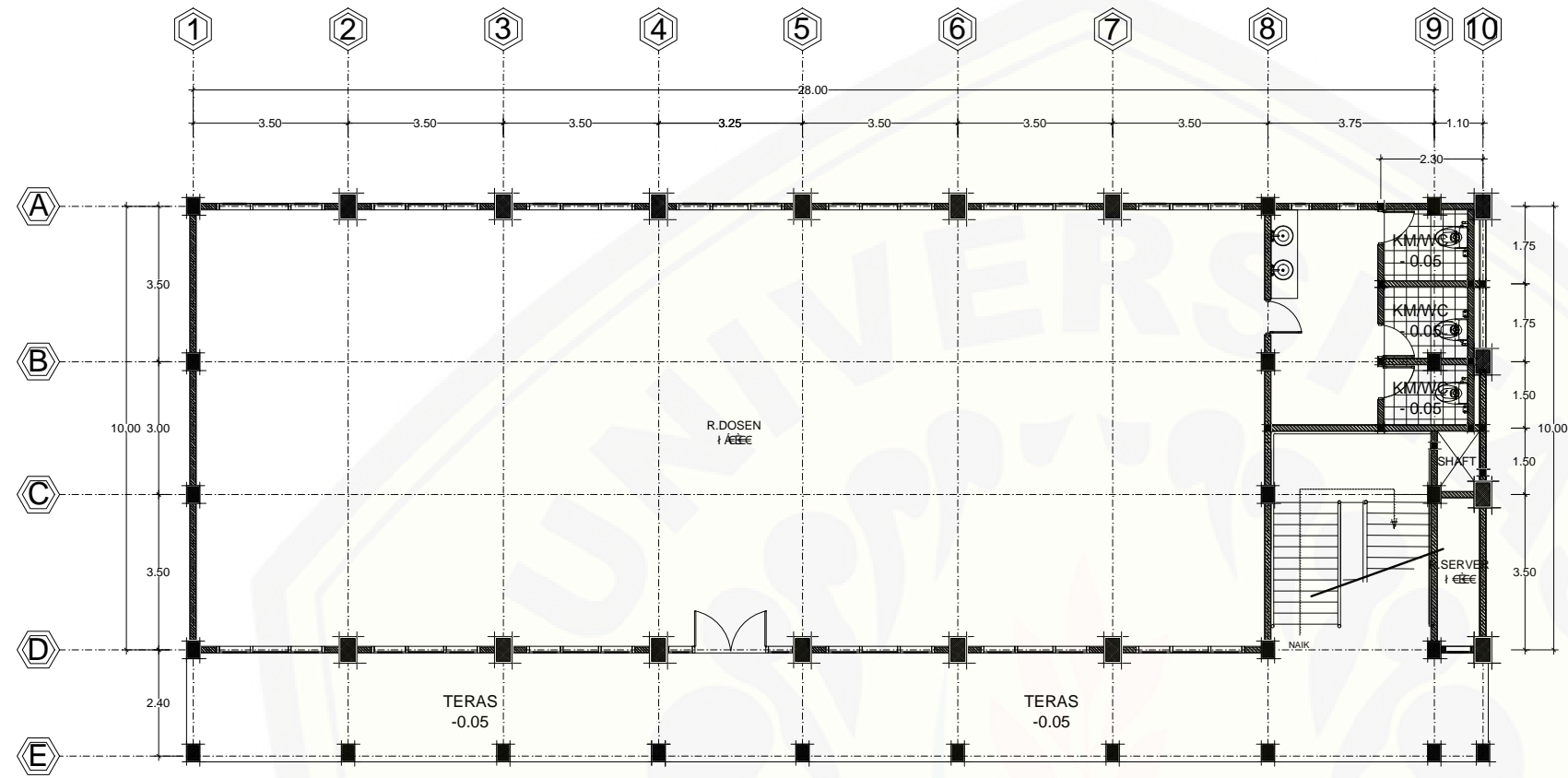

DENAH
SKALA 1 : 100

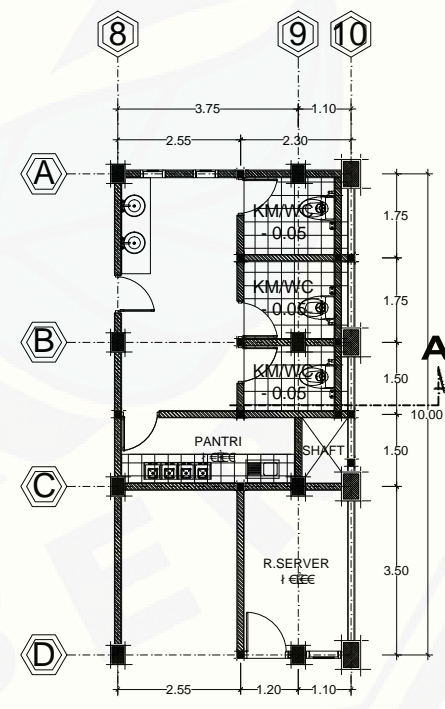

DETAIL DENAH BAWAH TANGGA
SKALA 1 : 100



KEGIATAN		
SARANA / PRASARANA PENDUKUNG PEMBELAJARAN		
PEKERJAAN		
PEMBANGUNAN GEDUNG AKUNTANSI FAKULTAS EKONOMI (TAHAP 1)		
LOKASI		
UNIVERSITAS JEMBER		
MENGETAHUI / MENYETUJUI	TGL	TANDA TANGAN
PEMBANTU REKTOR II UNIVERSITAS JEMBER DR. AKHMAD TOHA, M.Si. NIP. 19571227 198702 1 002		
MENGETAHUI / MENYETUJUI	TGL	TANDA TANGAN
PEJABAT PEMBUAT KOMITMEN UNIVERSITAS JEMBER BADERUN, SE NIP. 19630215 198703 1 002		
MENGETAHUI / MENYETUJUI	TGL	TANDA TANGAN
KEPALA BIRO III UNIVERSITAS JEMBER Drs. SUGIARTO, S.H., M.M. NIP. 19591220 198003 1 001		
MENGETAHUI / MENYETUJUI	TGL	TANDA TANGAN
DEKAN FAKULTAS EKONOMI UNIVERSITAS JEMBER DR. M. FATHORRAZI, M.Si. NIP. 196306 14199002 1 001		
MENGETAHUI / MENYETUJUI	TGL	TANDA TANGAN
KETUA TIM TEKNIS Ir. HERNU SUYOSO, M.T. NIP. 19551112 198702 1 001		
KONSULTAN PERENCANA		
 Architect - Planner - Construction - Consultant PT. DEWI PERMATA MANDIRI Kantor : Jl. Langsep Raya No. 02A / 08 Tlp. (0331) 424080 Jember 68111 . Perencana - Perancang - Pengawas & Manajemen Konstruksi .		
DIGAMBAR	DIPERIKSA	PENANGGUNG JAWAB GAMBAR
SOLEHUDIN ZUHRI, ST. DRAFTER	Ir. PONIMAN TENAGA AHLI STRUKTUR	Ir. SRIWIYONO DIREKTUR UTAMA
JUDUL GAMBAR		SKALA
DENAH		1 : 150
KODE GAMBAR	NOMOR LEMBAR	JUMLAH LEMBAR
STR	00	31

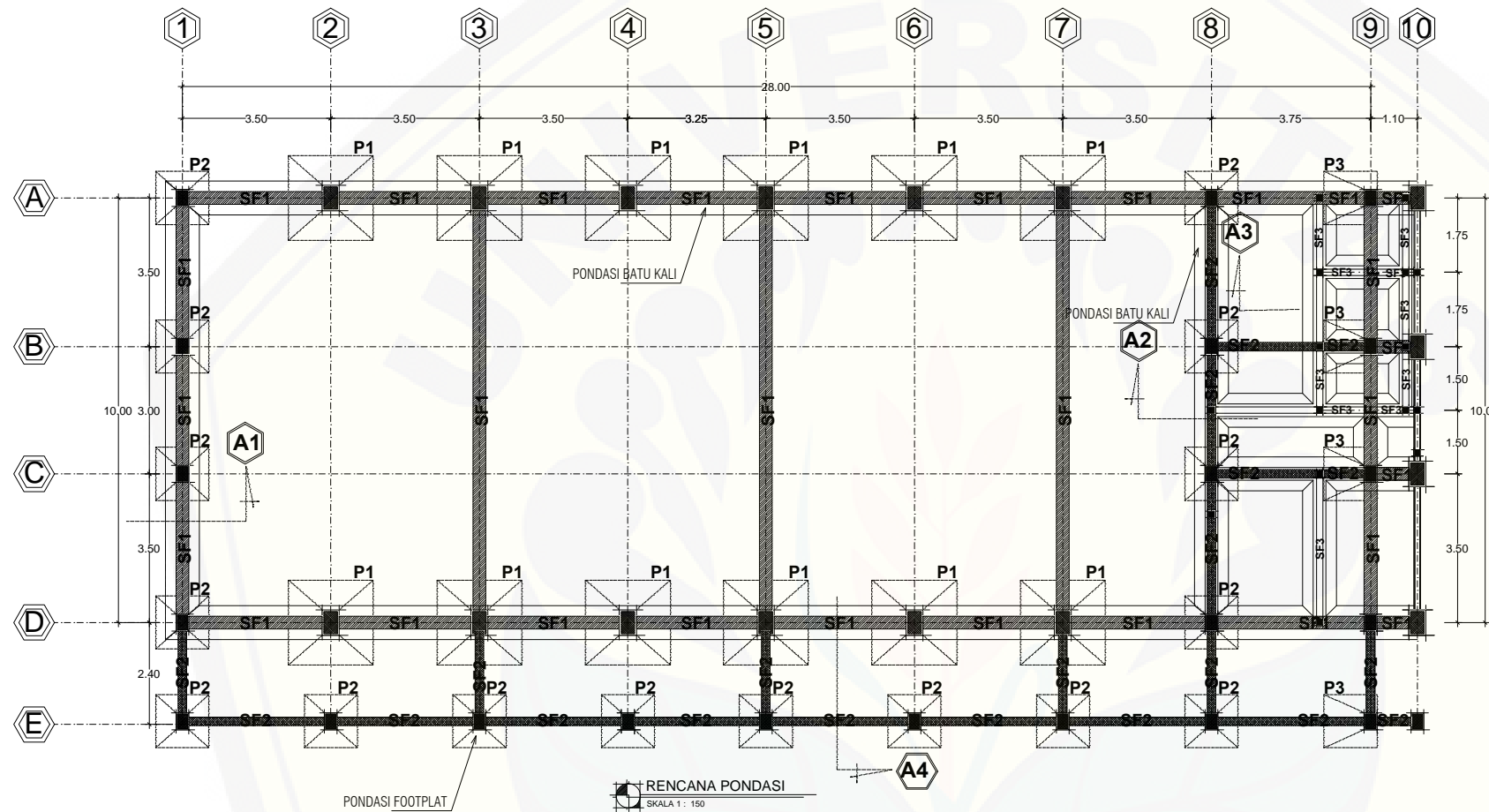

KETERANGAN

- = (SF1) SLOOF 30/60
- = (SF2) SLOOF 20/40
- = (SF3) SLOOF 15/20



KEMENTERIAN RISET, TEKNOLOGI
DAN PENDIDIKAN TINGGI
UNIVERSITAS JEMBER
Jl. Kalimantan no. 37 Kampus Tegol Boto Kotak Pos 159
Telp. (0331) 32445, 324446 Fax (0331) - 339029, 337422
JEMBER

KEGIATAN

SARANA / PRASARANA
PENDUKUNG PEMBELAJARAN

PEKERJAAN

PEMBANGUNAN GEDUNG
AKUNTANSI FAKULTAS EKONOMI
(TAHAP 1)

LOKASI

UNIVERSITAS JEMBER

MENGETAHUI / MENYETUJUI	TGL	TANDA TANGAN
PEMBANTU REKTOR II UNIVERSITAS JEMBER DR. AKHMAD TOHA, M.Si. NIP. 19571227 198702 1 002		
MENGETAHUI / MENYETUJUI	TGL	TANDA TANGAN
PEJABAT PEMBUAT KOMITMEN UNIVERSITAS JEMBER BADERUN, SE NIP. 19630215 198703 1 002		
MENGETAHUI / MENYETUJUI	TGL	TANDA TANGAN
KEPALA BIRO III UNIVERSITAS JEMBER Drs. SUGIARTO, S.H., M.M. NIP. 19591220 198003 1 001		
MENGETAHUI / MENYETUJUI	TGL	TANDA TANGAN
DEKAN FAKULTAS EKONOMI UNIVERSITAS JEMBER DR. M. FATHORRAZI, M.Si. NIP. 196306 14199002 1 001		
MENGETAHUI / MENYETUJUI	TGL	TANDA TANGAN
KETUA TIM TEKNIS Ir. HERNU SUYOSO, M.T. NIP. 19551112 198702 1 001		

KONSULTAN PERENCANA

Architect - Planner - Construction - Consultant
PT. DEWI PERMATA MANDIRI
Kantor : Jl. Langsep Raya No. 02A / 08 Tlp. (0331) 424080 Jember 68111
. Perencana - Perancang - Pengawas & Manajemen Konstruksi .

DIGAMBAR	DIPERIKSA	PENANGGUNG JAWAB GAMBAR
SOLEHUDIN ZUHRI, ST. DRAFTER	Ir. PONIMAN TENAGA AHLI STRUKTUR	Ir. SRIWIYONO DIREKTUR UTAMA
JUDUL GAMBAR		SKALA
RENCANA PONDASI		1 : 150
KODE GAMBAR	NOMOR LEMBAR	JUMLAH LEMBAR
STR	01	31

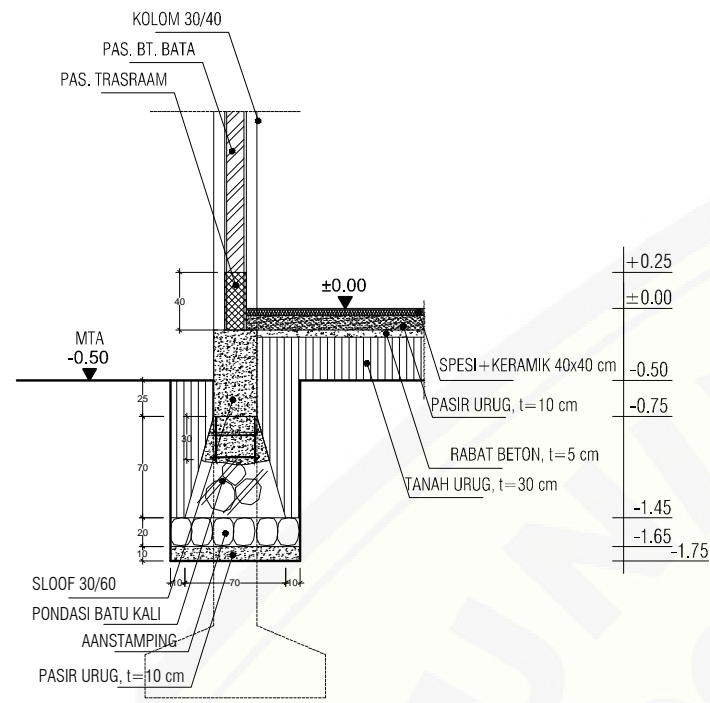

POTONGAN A1
SKALA 1 : 50

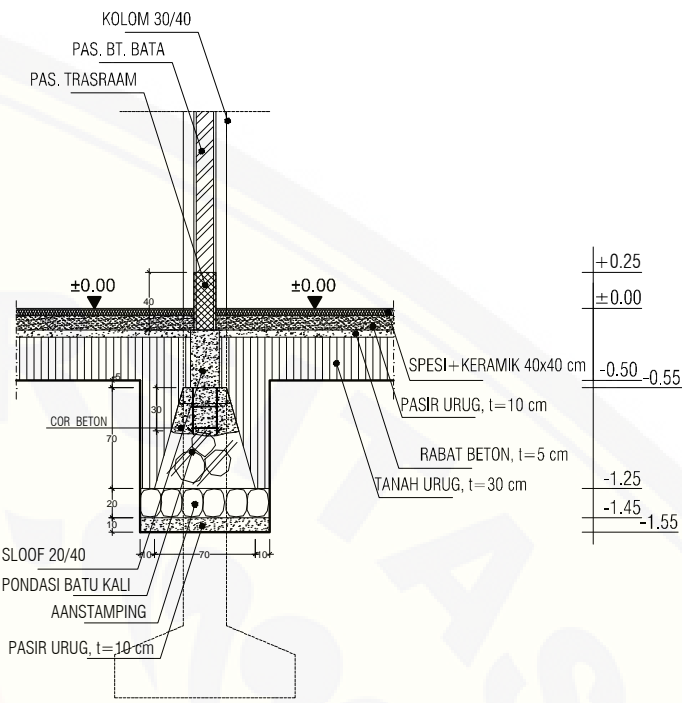

POTONGAN A2
SKALA 1 : 50

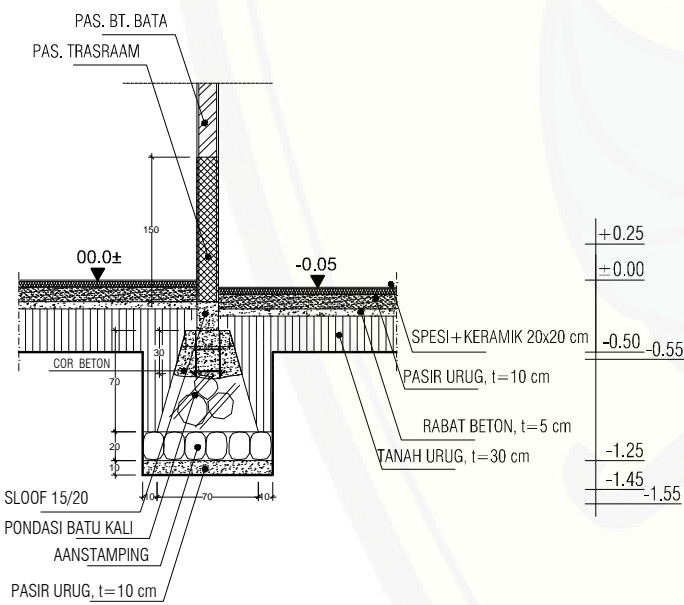

POTONGAN A3
SKALA 1 : 50

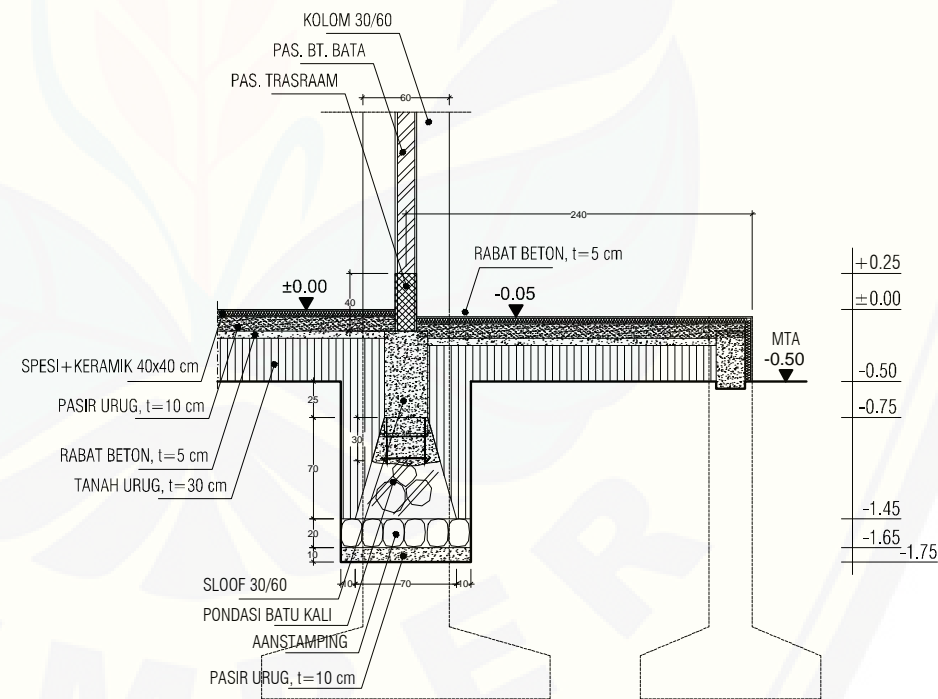

POTONGAN A4
SKALA 1 : 50



KEMENTERIAN RISET, TEKNOLOGI
DAN PENDIDIKAN TINGGI
UNIVERSITAS JEMBER
Jl. Kalimantan no. 37 Kampus Tegol Boto Kotak Pos 159
Telp. (0331) 32445, 324446 Fax (0331) - 339029, 337422
JEMBER

KEGIATAN		
SARANA / PRASARANA PENDUKUNG PEMBELAJARAN		
PEKERJAAN		
PEMBANGUNAN GEDUNG AKUNTANSI FAKULTAS EKONOMI (TAHAP 1)		
LOKASI		
UNIVERSITAS JEMBER		
MENGETAHUI / MENYETUJUI	TGL	TANDA TANGAN
PEMBANTU REKTOR II UNIVERSITAS JEMBER DR. AKHMAD TOHA, M.Si. NIP. 19571227 198702 1 002		
MENGETAHUI / MENYETUJUI	TGL	TANDA TANGAN
PEJABAT PEMBUAT KOMITMEN UNIVERSITAS JEMBER BADERUN, SE NIP. 19630215 198703 1 002		
MENGETAHUI / MENYETUJUI	TGL	TANDA TANGAN
KEPALA BIRO III UNIVERSITAS JEMBER Drs. SUGIARTO, S.H., M.M. NIP. 19591220 198003 1 001		
MENGETAHUI / MENYETUJUI	TGL	TANDA TANGAN
DEKAN FAKULTAS EKONOMI UNIVERSITAS JEMBER DR. M. FATHORRAZI, M.Si. NIP. 196306 14199002 1 001		
MENGETAHUI / MENYETUJUI	TGL	TANDA TANGAN
KETUA TIM TEKNIS Ir. HERNU SUYOSO, M.T. NIP. 19551112 198702 1 001		
KONSULTAN PERENCANA		
Architect - Planner - Construction - Consultant		
PT. DEWI PERMATA MANDIRI Kantor : Jl. Langsep Raya No. 02A / 08 Tlp. (0331) 424080 Jember 68111 . Perencana - Perancang - Pengawas & Manajemen Konstruksi .		
DIGAMBAR	DIPERIKSA	PENANGGUNG JAWAB GAMBAR
SOLEHUJIN ZUHRI, ST. DRAFTER	Ir. PONIMAN TENAGA AHLI STRUKTUR	Ir. SRIWIYONO DIREKTUR UTAMA
JUDUL GAMBAR		SKALA
DETAIL PONDASI		1 : 50
KODE GAMBAR	NOMOR LEMBAR	JUMLAH LEMBAR
STR	02	31

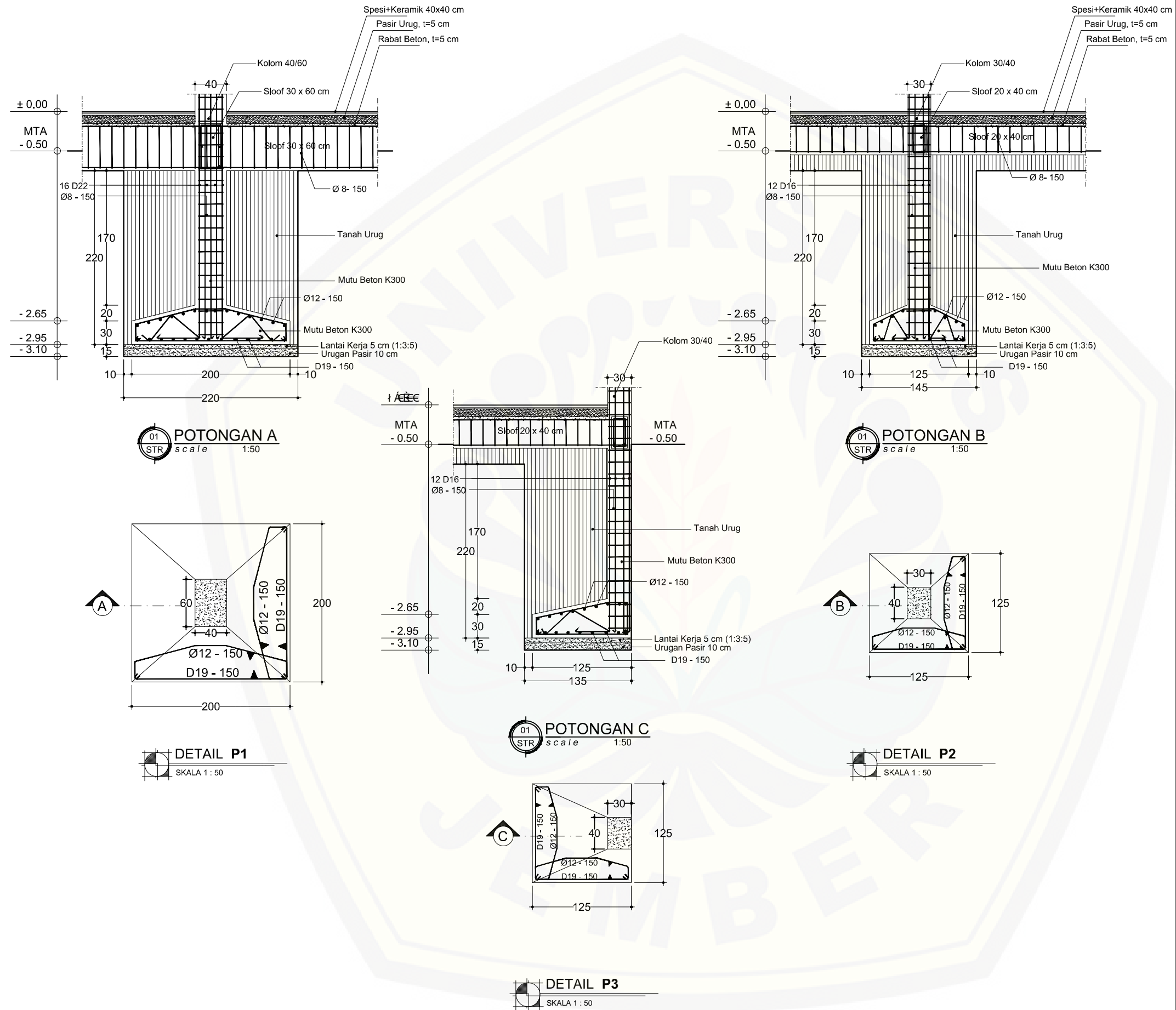

KEMENTERIAN RISET, TEKNOLOGI DAN PENDIDIKAN TINGGI
UNIVERSITAS JEMBER
 Jl. Kalimantan no. 37 Kampus Tegol Boto Kotak Pos 159
 Telp. (0331) 32445, 32446 Fax (0331) - 339029, 337422
JEMBER

KEGIATAN
SARANA / PRASARANA PENDUKUNG PEMBELAJARAN
 PEKERJAAN
PEMBANGUNAN GEDUNG AKUNTANSI FAKULTAS EKONOMI (TAHAP 1)

LOKASI
UNIVERSITAS JEMBER

MENGETAHUI / MENYETUJUI	TGL	TANDA TANGAN
PEMBANTU REKTOR II UNIVERSITAS JEMBER		
DR. AKHMAD TOHA, M.Si. NIP. 19571227 198702 1 002		
MENGETAHUI / MENYETUJUI	TGL	TANDA TANGAN
PEJABAT PEMBUAT KOMITMEN UNIVERSITAS JEMBER		
BADERUN, SE NIP. 19630215 198703 1 002		
MENGETAHUI / MENYETUJUI	TGL	TANDA TANGAN
KEPALA BIRO III UNIVERSITAS JEMBER		
Drs. SUGIARTO, S.H., M.M. NIP. 19591220 198003 1 001		
MENGETAHUI / MENYETUJUI	TGL	TANDA TANGAN
DEKAN FAKULTAS EKONOMI UNIVERSITAS JEMBER		
DR. M. FATHORRAZI, M.Si. NIP. 196306 14199002 1 001		
MENGETAHUI / MENYETUJUI	TGL	TANDA TANGAN
KETUA TIM TEKNIS		
Ir. HERNU SUYOSO, M.T. NIP. 19551112 198702 1 001		

KONSULTAN PERENCANA
 Architect - Planner - Construction - Consultant
PT. DEWI PERMATA MANDIRI
 Kantor : Jl. Langsep Raya No. 02A / 08 Tlp. (0331) 424080 Jember 68111
 . Perencana - Perancang - Pengawas & Manajemen Konstruksi .

DIGAMBAR	DIPERIKSA	PENANGGUNG JAWAB GAMBAR
SOLEHUJIN ZUHRI, ST. DRAFTER	Ir. PONIMAN TENAGA AHLI STRUKTUR	Ir. SRIWIYONO DIREKTUR UTAMA
JUDUL GAMBAR		SKALA
DETAIL PONDASI		1 : 50
KODE GAMBAR	NOMOR LEMBAR	JUMLAH LEMBAR
STR	03	31



KEMENTERIAN RISET, TEKNOLOGI DAN PENDIDIKAN TINGGI
UNIVERSITAS JEMBER
 Jl. Kalimantan no. 37 Kampus Tegol Boto Kotak Pos 159
 Telp. (0331) 32445, 324446 Fax (0331) - 339029, 337422
JEMBER

KEGIATAN		
SARANA / PRASARANA PENDUKUNG PEMBELAJARAN		
PEKERJAAN		
PEMBANGUNAN GEDUNG AKUNTANSI FAKULTAS EKONOMI (TAHAP 1)		
LOKASI		
UNIVERSITAS JEMBER		
MENGETAHUI / MENYETUJUI	TGL	TANDA TANGAN
PEMBANTU REKTOR II UNIVERSITAS JEMBER		
DR. AKHMAD TOHA, M.Si. NIP. 19571227 198702 1 002		
MENGETAHUI / MENYETUJUI	TGL	TANDA TANGAN
PEJABAT PEMBUAT KOMITMEN UNIVERSITAS JEMBER		
BADERUN, SE NIP. 19630215 198703 1 002		
MENGETAHUI / MENYETUJUI	TGL	TANDA TANGAN
KEPALA BIRO III UNIVERSITAS JEMBER		
Drs. SUGIARTO, S.H., M.M. NIP. 19591220 198003 1 001		
MENGETAHUI / MENYETUJUI	TGL	TANDA TANGAN
DEKAN FAKULTAS EKONOMI UNIVERSITAS JEMBER		
DR. M. FATHORRAZI, M.Si. NIP. 196306 14199002 1 001		
MENGETAHUI / MENYETUJUI	TGL	TANDA TANGAN
KETUA TIM TEKNIS		
Ir. HERNU SUYOSO, M.T. NIP. 19551112 198702 1 001		
KONSULTAN PERENCANA		
Architect - Planner - Construction - Consultant		
PT. DEWI PERMATA MANDIRI Kantor : Jl. Langsep Raya No. 02A / 08 Tlp. (0331) 424080 Jember 68111 . Perencana - Perancang - Pengawas & Manajemen Konstruksi .		
DIGAMBAR	DIPERIKSA	PENANGGUNG JAWAB GAMBAR
SOLEHUJIN ZUHRI, ST. DRAFTER	Ir. PONIMAN TENAGA AHLI STRUKTUR	Ir. SRIWIYONO DIREKTUR UTAMA
JUDUL GAMBAR		SKALA
KEYPLAN KOLOM		1 : 150
KODE GAMBAR	NOMOR LEMBAR	JUMLAH LEMBAR
ARS	04	31

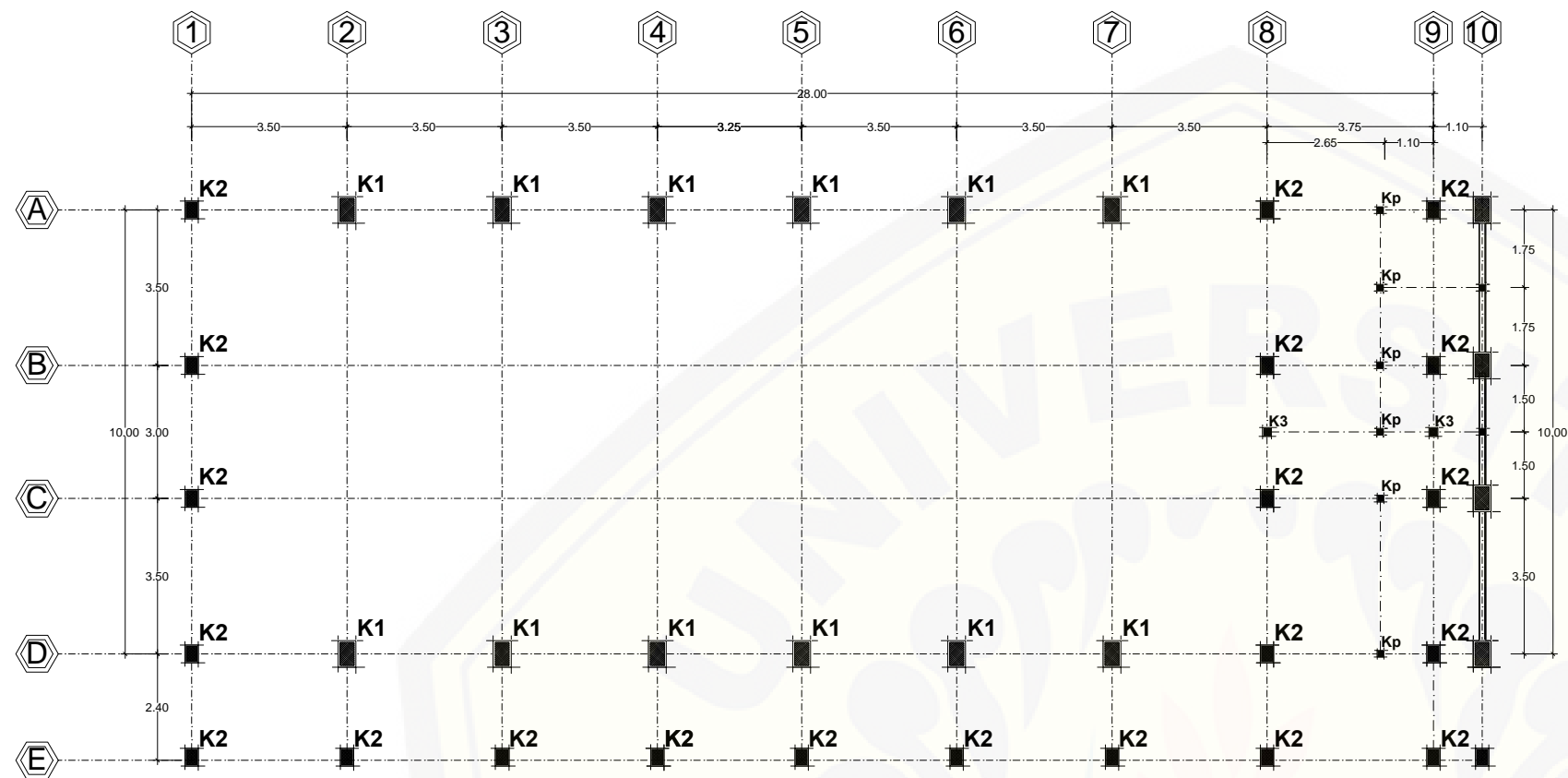

KEYPLAN KOLOM LANTAI 1
 SKALA 1 : 150

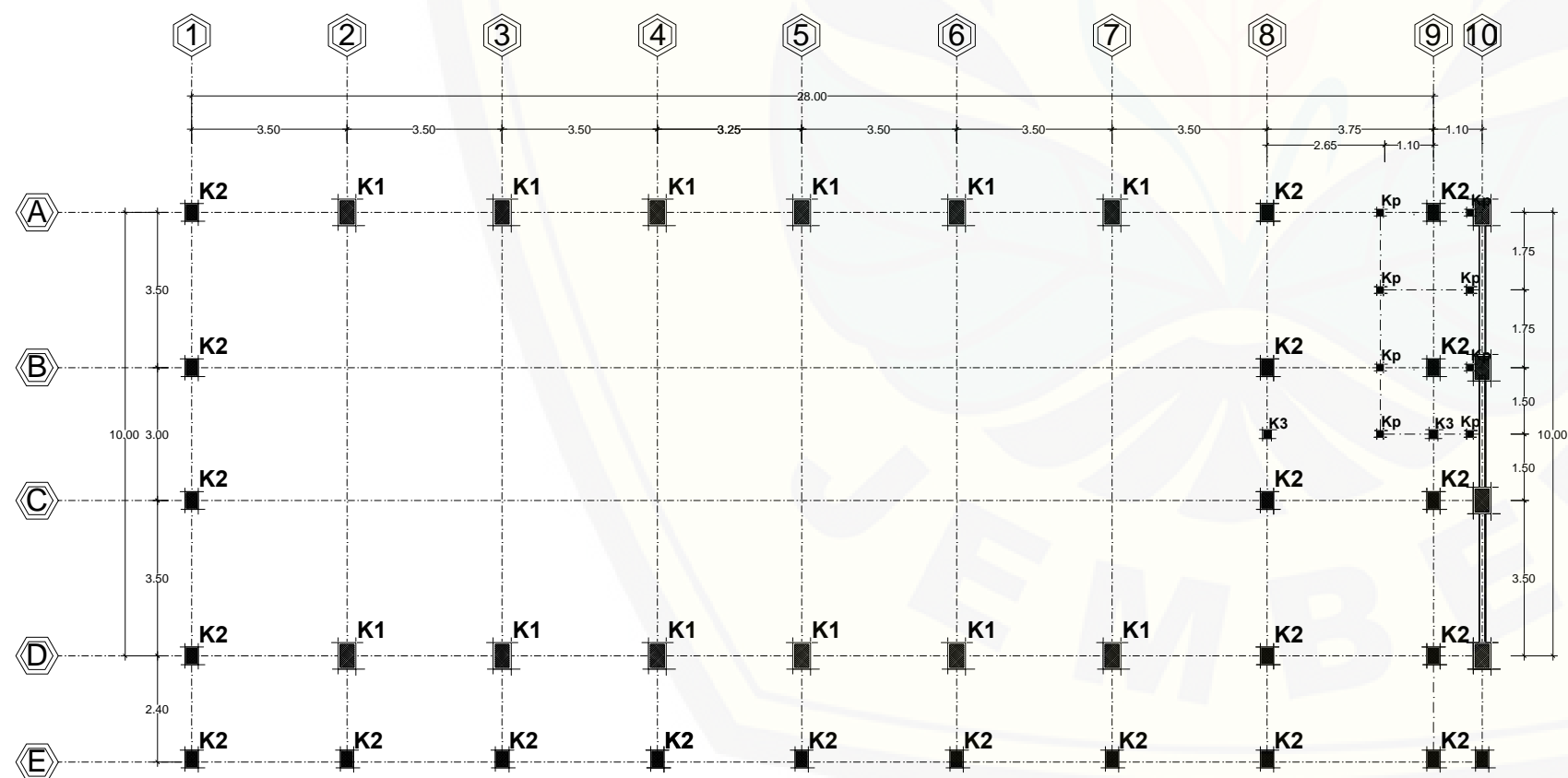

KEYPLAN KOLOM LANTAI 2
 SKALA 1 : 150

KETERANGAN :
K1 = KOLOM 40/60
K2 = KOLOM 30/40
K3 = KOLOM 20/20
KP = KOLOM PRAKTIS 12/12



KEMENTERIAN RISET, TEKNOLOGI
DAN PENDIDIKAN TINGGI
UNIVERSITAS JEMBER
Jl. Kalimantan no. 37 Kampus Tegay Boto Kotak Pos 159
Telp. (0331) 32445, 324446 Fax (0331) - 339029, 337422
JEMBER

KEGIATAN

SARANA / PRASARANA
PENDUKUNG PEMBELAJARAN

PEKERJAAN

PEMBANGUNAN GEDUNG
AKUNTANSI FAKULTAS EKONOMI
(TAHAP 1)

LOKASI

UNIVERSITAS JEMBER

MENGETAHUI / MENYETUJUI	TGL	TANDA TANGAN
PEMBANTU REKTOR II UNIVERSITAS JEMBER DR. AKHMAD TOHA, M.Si. NIP. 19571227 198702 1 002		
PEJABAT PEMBUAT KOMITMEN UNIVERSITAS JEMBER BADERUN, SE NIP. 19630215 198703 1 002		
KEPALA BIRO III UNIVERSITAS JEMBER Drs. SUGIARTO, S.H., M.M. NIP. 19591220 198003 1 001		
DEKAN FAKULTAS EKONOMI UNIVERSITAS JEMBER DR. M. FATHORRAZI, M.Si. NIP. 196306 14199002 1 001		
KETUA TIM TEKNIS Ir. HERNU SUYOSO, M.T. NIP. 19551112 198702 1 001		

KONSULTAN PERENCANA

Architect - Planner - Construction - Consultant
PT. DEWI PERMATA MANDIRI
Kantor : Jl. Langsep Raya No. 02A / 08 Tlp. (0331) 424080 Jember 68111
. Perencana - Perancang - Pengawas & Manajemen Konstruksi .

DIGAMBAR	DIPERIKSA	PENANGGUNG JAWAB GAMBAR
SOLEHUJIN ZUHRI, ST. DRAFTER	Ir. PONIMAN TENAGA AHLI STRUKTUR	Ir. SRIWIYONO DIREKTUR UTAMA
JUDUL GAMBAR		SKALA
KEYPLAN KOLOM		1 : 150
KODE GAMBAR	NOMOR LEMBAR	JUMLAH LEMBAR
ARS	05	31

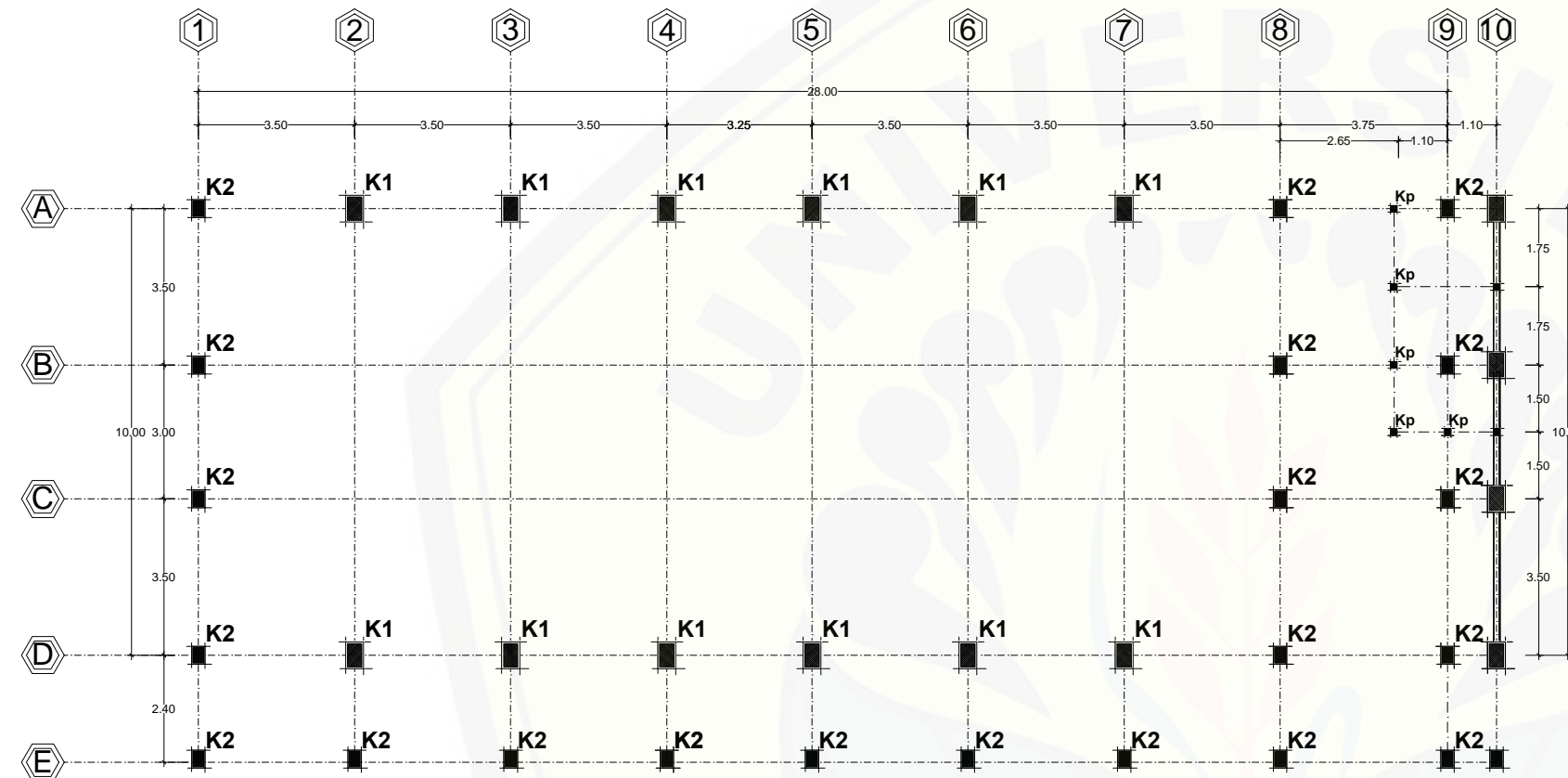

KETERANGAN :

K1 = KOLOM 40/60

K2 = KOLOM 30/40

KP = KOLOM PRAKTIS 12/12



KEMENTERIAN RISET, TEKNOLOGI DAN PENDIDIKAN TINGGI
UNIVERSITAS JEMBER
 Jl. Kalimantan no. 37 Kampus Tegol Boto Kotak Pos 159
 Telp. (0331) 32445, 324446 Fax (0331) - 339029, 337422
JEMBER

KEGIATAN		
SARANA / PRASARANA PENDUKUNG PEMBELAJARAN		
PEKERJAAN		
PEMBANGUNAN GEDUNG AKUNTANSI FAKULTAS EKONOMI (TAHAP 1)		
LOKASI		
UNIVERSITAS JEMBER		
MENGETAHUI / MENYETUJUI	TGL	TANDA TANGAN
PEMBANTU REKTOR II UNIVERSITAS JEMBER		
DR. AKHMAD TOHA, M.Si. NIP. 19571227 198702 1 002		
MENGETAHUI / MENYETUJUI	TGL	TANDA TANGAN
PEJABAT PEMBUAT KOMITMEN UNIVERSITAS JEMBER		
BADERUN, SE NIP. 19630215 198703 1 002		
MENGETAHUI / MENYETUJUI	TGL	TANDA TANGAN
KEPALA BIRO III UNIVERSITAS JEMBER		
Drs. SUGIARTO, S.H., M.M. NIP. 19591220 198003 1 001		
MENGETAHUI / MENYETUJUI	TGL	TANDA TANGAN
DEKAN FAKULTAS EKONOMI UNIVERSITAS JEMBER		
DR. M. FATHORRAZI, M.Si. NIP. 196306 14199002 1 001		
MENGETAHUI / MENYETUJUI	TGL	TANDA TANGAN
KETUA TIM TEKNIS		
Ir. HERNU SUYOSO, M.T. NIP. 19551112 198702 1 001		
KONSULTAN PERENCANA		
 Architect - Planner - Construction - Consultant PT. DEWI PERMATA MANDIRI Kantor : Jl. Langsep Raya No. 02A / 08 Tlp. (0331) 424080 Jember 68111 . Perencana - Perancang - Pengawas & Manajemen Konstruksi .		
DIGAMBAR	DIPERIKSA	PENANGGUNG JAWAB GAMBAR
SOLEHUJIN ZUHRI, ST. DRAFTER	Ir. PONIMAN TENAGA AHLI STRUKTUR	Ir. SRIWIYONO DIREKTUR UTAMA
JUDUL GAMBAR		SKALA
RENCANA BALOK		1 : 150
KODE GAMBAR	NOMOR LEMBAR	JUMLAH LEMBAR
ARS	06	31





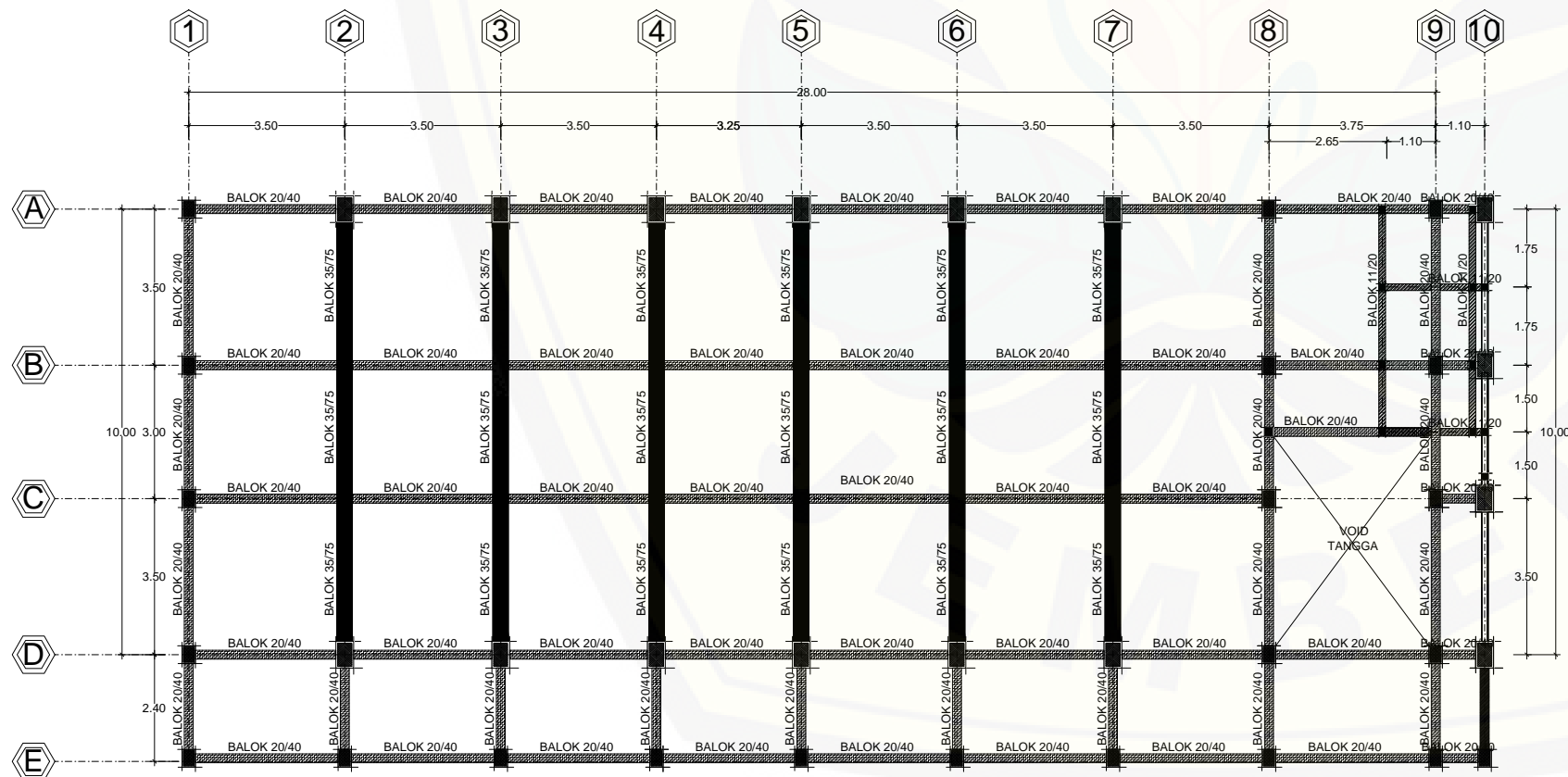

RENCANA BALOK ELEVASI +4.40
 SKALA 1 : 150

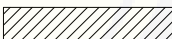

RENCANA BALOK ELEVASI +8.90
 SKALA 1 : 150

KETERANGAN

-  = BALOK 35/75
-  = BALOK 20/40
-  = BALOK 15/30
-  = BALOK 11/20

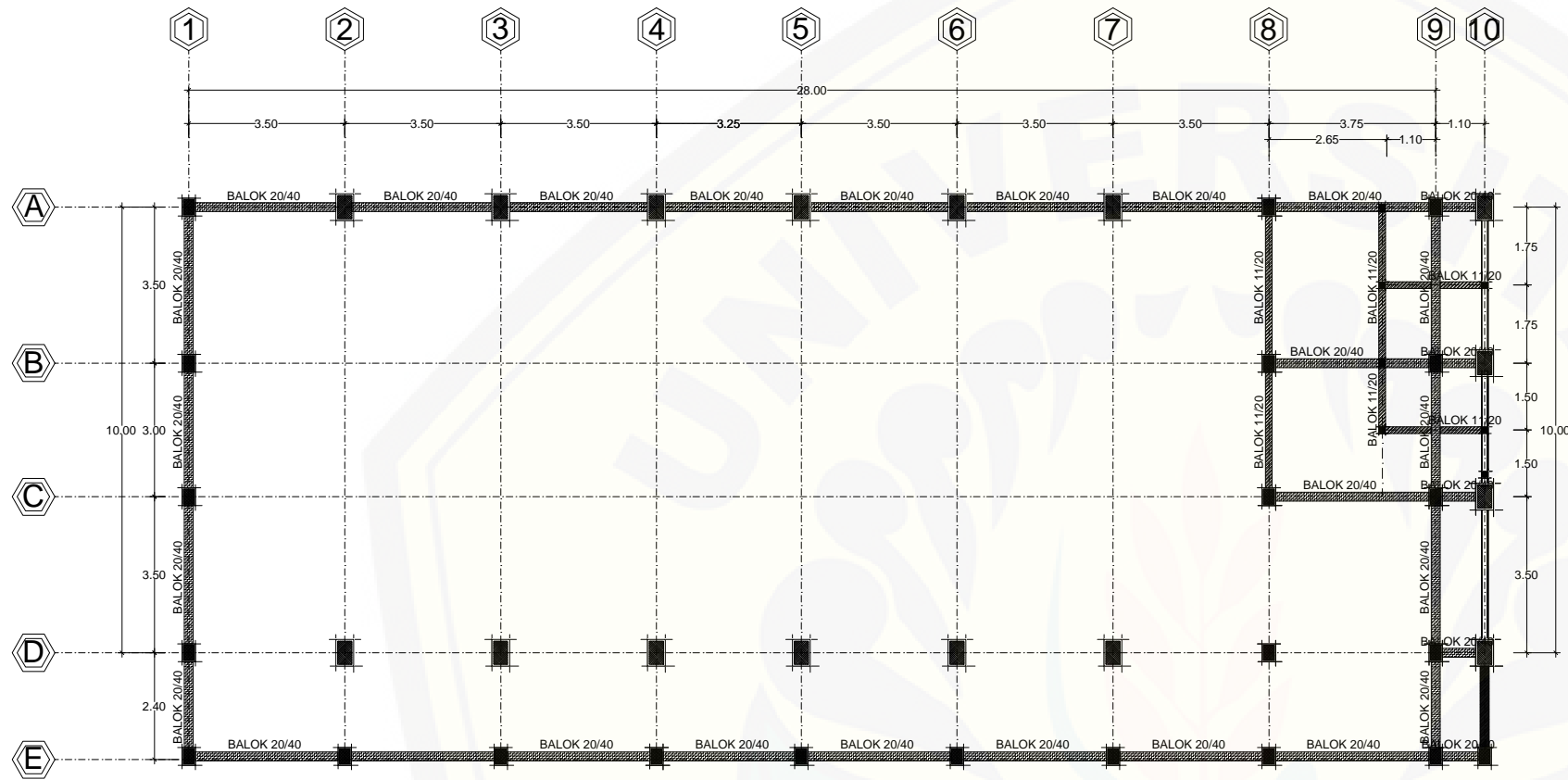

RENCANA BALOK ELEVASI +13.50
SKALA 1 : 150

KETERANGAN :

- = BALOK 35/75
- = BALOK 20/40
- = BALOK 15/30
- = BALOK 11/20

**KEMENTERIAN RISET, TEKNOLOGI
DAN PENDIDIKAN TINGGI
UNIVERSITAS JEMBER**
Jl. Kalimantan no. 37 Kampus Tegol Boto Kotak Pos 159
Telp. (0331) 32445, 324446 Fax (0331) - 339029, 337422
JEMBER

KEGIATAN
**SARANA / PRASARANA
PENDUKUNG PEMBELAJARAN**
PEKERJAAN
**PEMBANGUNAN GEDUNG
AKUNTANSI FAKULTAS EKONOMI
(TAHAP 1)**
LOKASI
UNIVERSITAS JEMBER

MENGETAHUI / MENYETUJUI	TGL	TANDA TANGAN
PEMBANTU REKTOR II UNIVERSITAS JEMBER DR. AKHMAD TOHA, M.Si. NIP. 19571227 198702 1 002		
PEJABAT PEMBUAT KOMITMEN UNIVERSITAS JEMBER BADERUN, SE NIP. 19630215 198703 1 002		
KEPALA BIRO III UNIVERSITAS JEMBER Drs. SUGIARTO, S.H., M.M. NIP. 19591220 198003 1 001		
DEKAN FAKULTAS EKONOMI UNIVERSITAS JEMBER DR. M. FATHORRAZI, M.Si. NIP. 196306 14199002 1 001		
KETUA TIM TEKNIS Ir. HERNU SUYOSO, M.T. NIP. 19551112 198702 1 001		

KONSULTAN PERENCANA
Architect - Planner - Construction - Consultant
PT. DEWI PERMATA MANDIRI
Kantor : Jl. Langsep Raya No. 02A / 08 Tlp. (0331) 424080 Jember 68111
. Perencana - Perancang - Pengawas & Manajemen Konstruksi .

DIGAMBAR	DIPERIKSA	PENANGGUNG JAWAB GAMBAR
SOLEHUDIN ZUHRI, ST. DRAFTER	Ir. PONIMAN TENAGA AHLI STRUKTUR	Ir. SRIWIYONO DIREKTUR UTAMA
JUDUL GAMBAR		SKALA
RENCANA BALOK		1 : 150
KODE GAMBAR	NOMOR LEMBAR	JUMLAH LEMBAR
ARS	07	31

KEGIATAN		
SARANA / PRASARANA PENDUKUNG PEMBELAJARAN		
PEKERJAAN		
PEMBANGUNAN GEDUNG AKUNTANSI FAKULTAS EKONOMI (TAHAP 1)		
LOKASI		
UNIVERSITAS JEMBER		
MENGETAHUI / MENYETUJUI	TGL	TANDA TANGAN
PEMBANTU REKTOR II UNIVERSITAS JEMBER		
DR. AKHMAD TOHA, M.Si. NIP. 19571227 198702 1 002		
MENGETAHUI / MENYETUJUI	TGL	TANDA TANGAN
PEJABAT PEMBUAT KOMITMEN UNIVERSITAS JEMBER		
BADERUN, SE NIP. 19630215 198703 1 002		
MENGETAHUI / MENYETUJUI	TGL	TANDA TANGAN
KEPALA BIRO III UNIVERSITAS JEMBER		
Drs. SUGIARTO, S.H., M.M. NIP. 19591220 198003 1 001		
MENGETAHUI / MENYETUJUI	TGL	TANDA TANGAN
DEKAN FAKULTAS EKONOMI UNIVERSITAS JEMBER		
DR. M. FATHORRAZI, M.Si. NIP. 196306 14199002 1 001		
MENGETAHUI / MENYETUJUI	TGL	TANDA TANGAN
KETUA TIM TEKNIS		
Ir. HERNU SUYOSO, M.T. NIP. 19551112 198702 1 001		

KONSULTAN PERENCANA
 Architect - Planner - Construction - Consultant
PT. DEWI PERMATA MANDIRI
 Kantor : Jl. Langsep Raya No. 02A / 08 Tlp. (0331) 424080 Jember 68111
 . Perencana - Perancang - Pengawas & Manajemen Konstruksi .

DIGAMBAR	DIPERIKSA	PENANGGUNG JAWAB GAMBAR
SOLEHUJIN ZUHRI, ST. DRAFTER	Ir. PONIMAN TENAGA AHLI STRUKTUR	Ir. SRIWIYONO DIREKTUR UTAMA
JUDUL GAMBAR		SKALA
RENCANA BALOK GANTUNG		1 : 150
KODE GAMBAR	NOMOR LEMBAR	JUMLAH LEMBAR
ARS	08	31

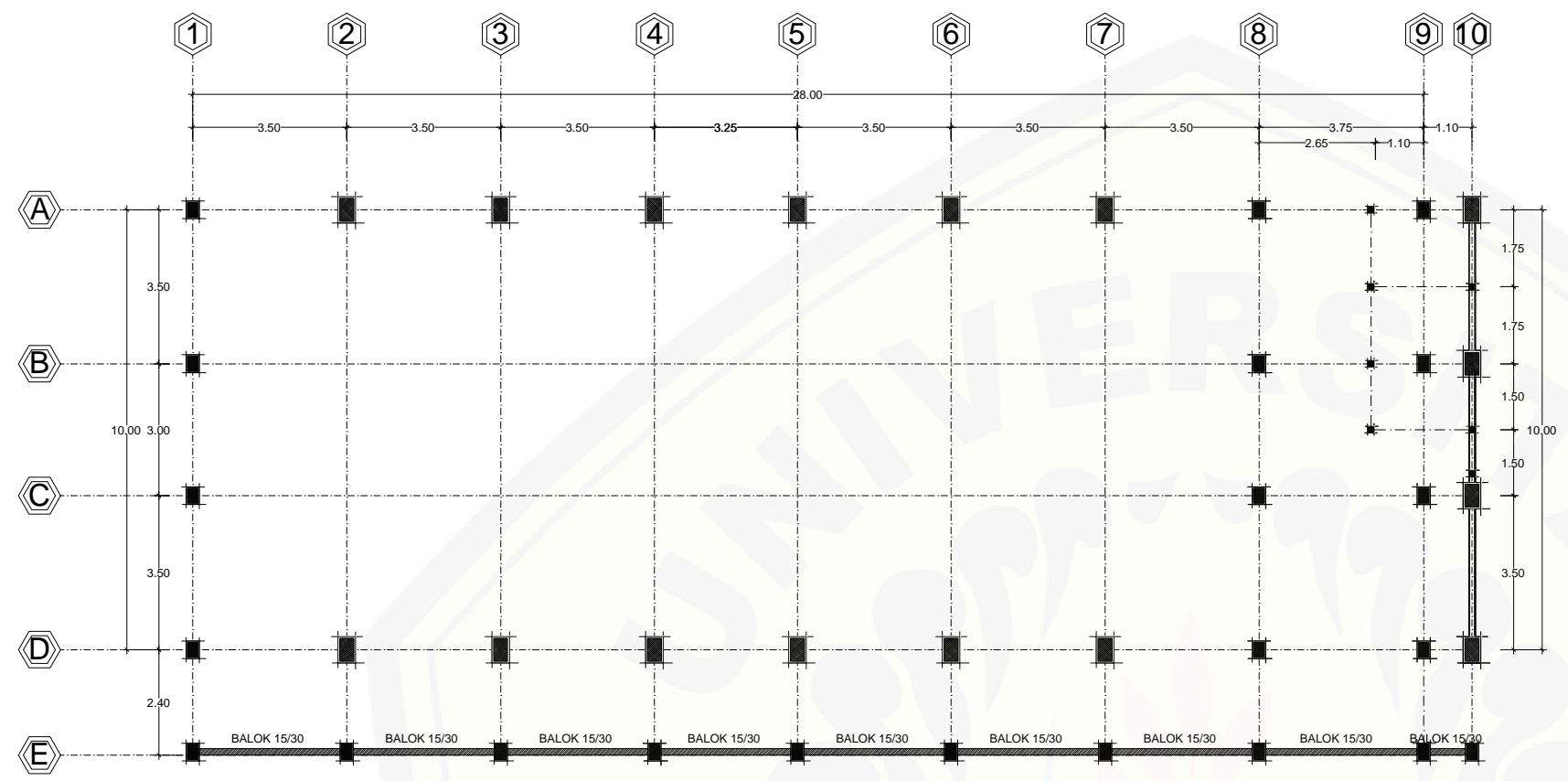

RENCANA BALOK GANTUNG ELEVASI +3.50
 SKALA 1 : 150

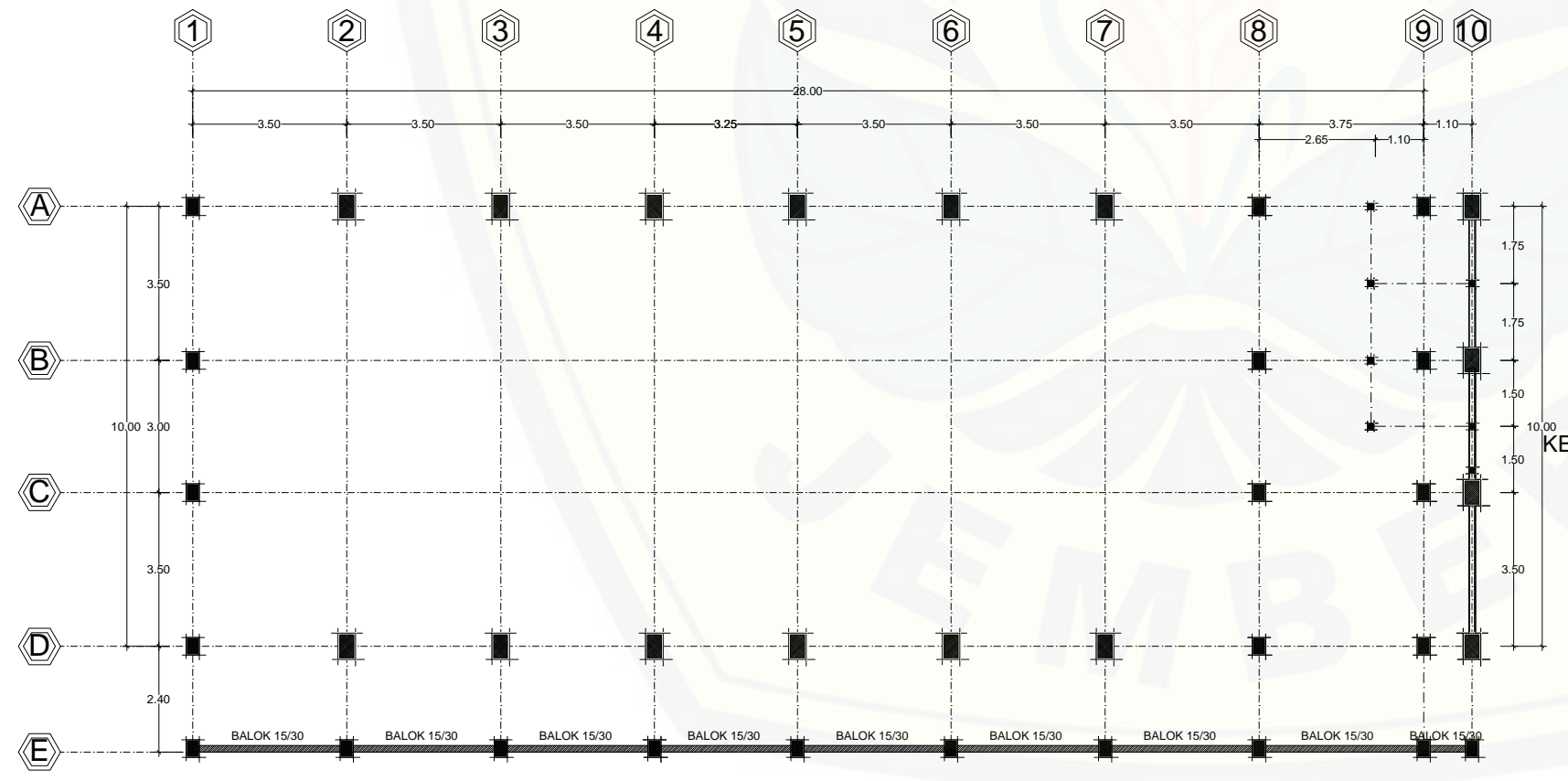

RENCANA BALOK GANTUNG ELEVASI +8.00
 SKALA 1 : 150

- KETERANGAN :**
- = BALOK 35/75
 - = BALOK 20/40
 - = BALOK 15/30
 - = BALOK 11/20



KEMENTERIAN RISET, TEKNOLOGI DAN PENDIDIKAN TINGGI
UNIVERSITAS JEMBER
 Jl. Kalimantan no. 37 Kampus Tegol Boto Kotak Pos 159
 Telp. (0331) 32445, 32446 Fax (0331) - 339029, 337422
JEMBER

KEGIATAN
**SARANA / PRASARANA
 PENDUKUNG PEMBELAJARAN**

PEKERJAAN
**PEMBANGUNAN GEDUNG
 AKUNTANSI FAKULTAS EKONOMI
 (TAHAP 1)**

LOKASI
UNIVERSITAS JEMBER

MENGETAHUI / MENYETUJUI	TGL	TANDA TANGAN
PEMBANTU REKTOR II UNIVERSITAS JEMBER		
DR. AKHMAD TOHA, M.Si. NIP. 19571227 198702 1 002		

MENGETAHUI / MENYETUJUI	TGL	TANDA TANGAN
PEJABAT PEMBUAT KOMITMEN UNIVERSITAS JEMBER		
BADERUN, SE NIP. 19630215 198703 1 002		

MENGETAHUI / MENYETUJUI	TGL	TANDA TANGAN
KEPALA BIRO III UNIVERSITAS JEMBER		
Drs. SUGIARTO, S.H., M.M. NIP. 19591220 198003 1 001		

MENGETAHUI / MENYETUJUI	TGL	TANDA TANGAN
DEKAN FAKULTAS EKONOMI UNIVERSITAS JEMBER		
DR. M. FATHORRAZI, M.Si. NIP. 196306 14199002 1 001		

MENGETAHUI / MENYETUJUI	TGL	TANDA TANGAN
KETUA TIM TEKNIS		
Ir. HERNU SUYOSO, M.T. NIP. 19551112 198702 1 001		

KONSULTAN PERENCANA

Architect - Planner - Construction - Consultant
PT. DEWI PERMATA MANDIRI
 Kantor : Jl. Langsep Raya No. 02A / 08 Tlp. (0331) 424080 Jember 68111
 . Perencana - Perancang - Pengawas & Manajemen Konstruksi .

DIGAMBAR	DIPERIKSA	PENANGGUNG JAWAB GAMBAR
SOLEHUJIN ZUHRI, ST. DRAFTER	Ir. PONIMAN TENAGA AHLI STRUKTUR	Ir. SRIWIYONO DIREKTUR UTAMA
JUDUL GAMBAR		SKALA
RENCANA PLAT LANTAI		1 : 150
KODE GAMBAR	NOMOR LEMBAR	JUMLAH LEMBAR
ARS	09	31

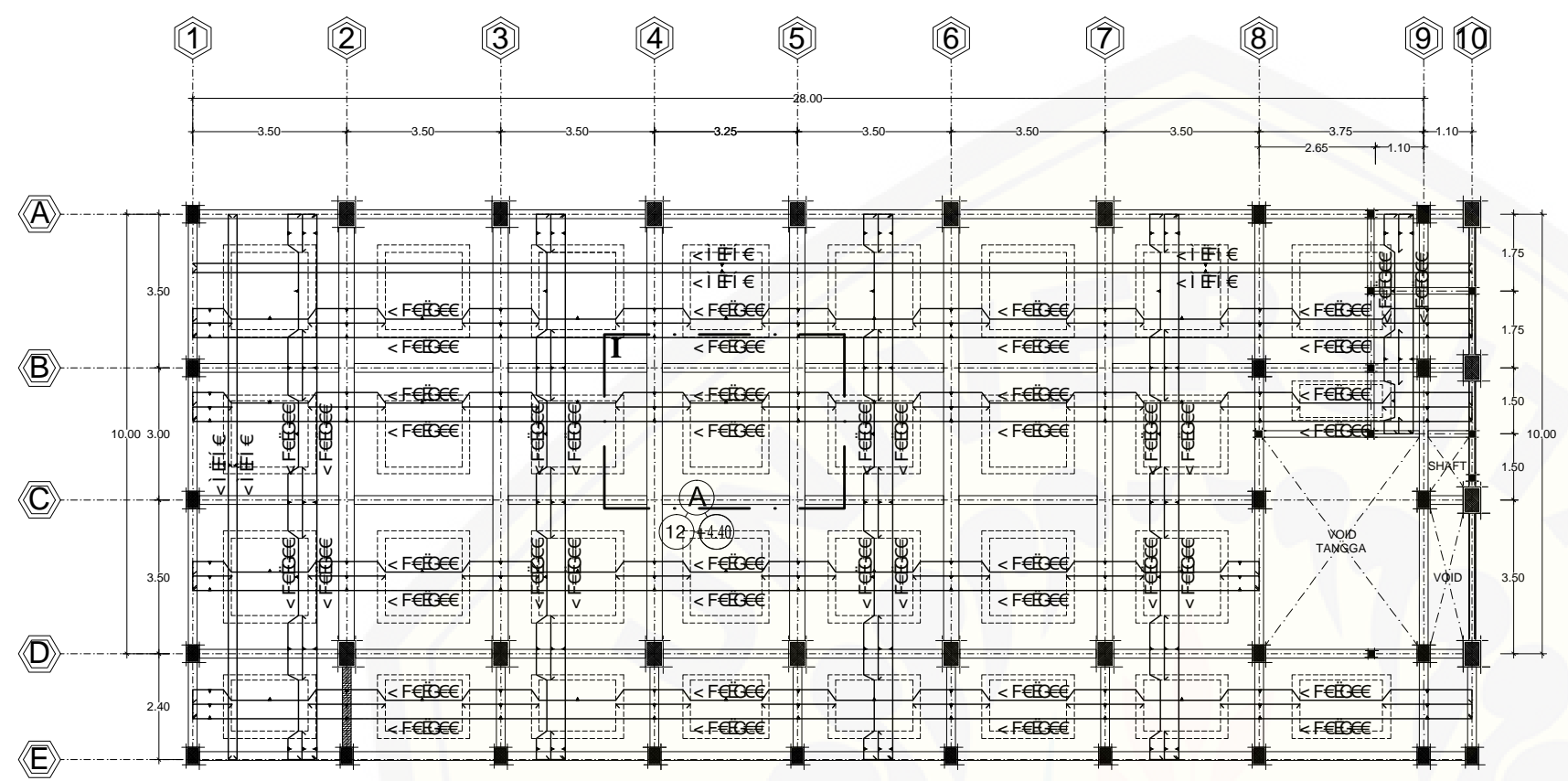

RENCANA PLAT LANTAI II
 SKALA 1 : 150

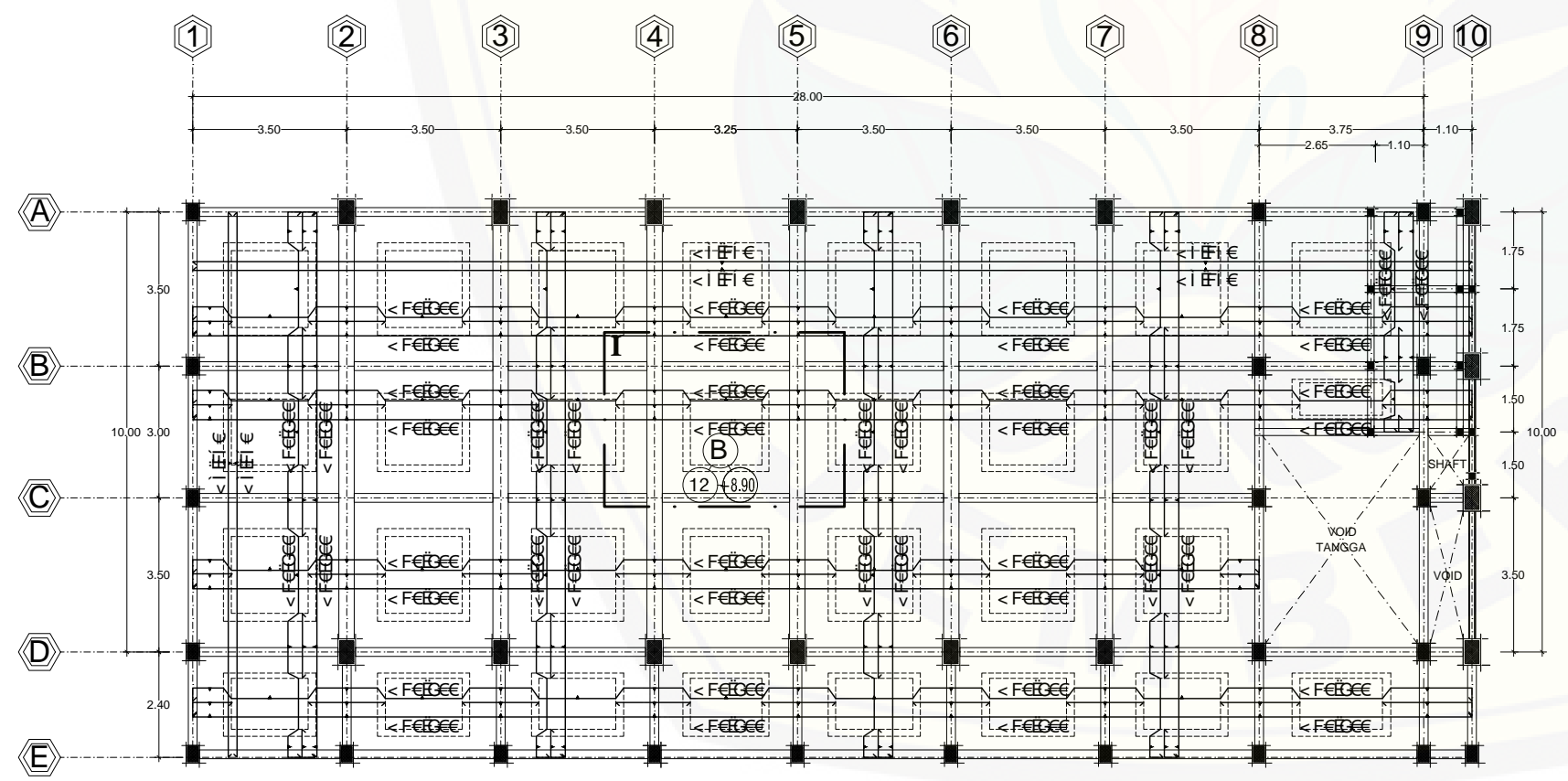

RENCANA PLAT LANTAI III
 SKALA 1 : 150

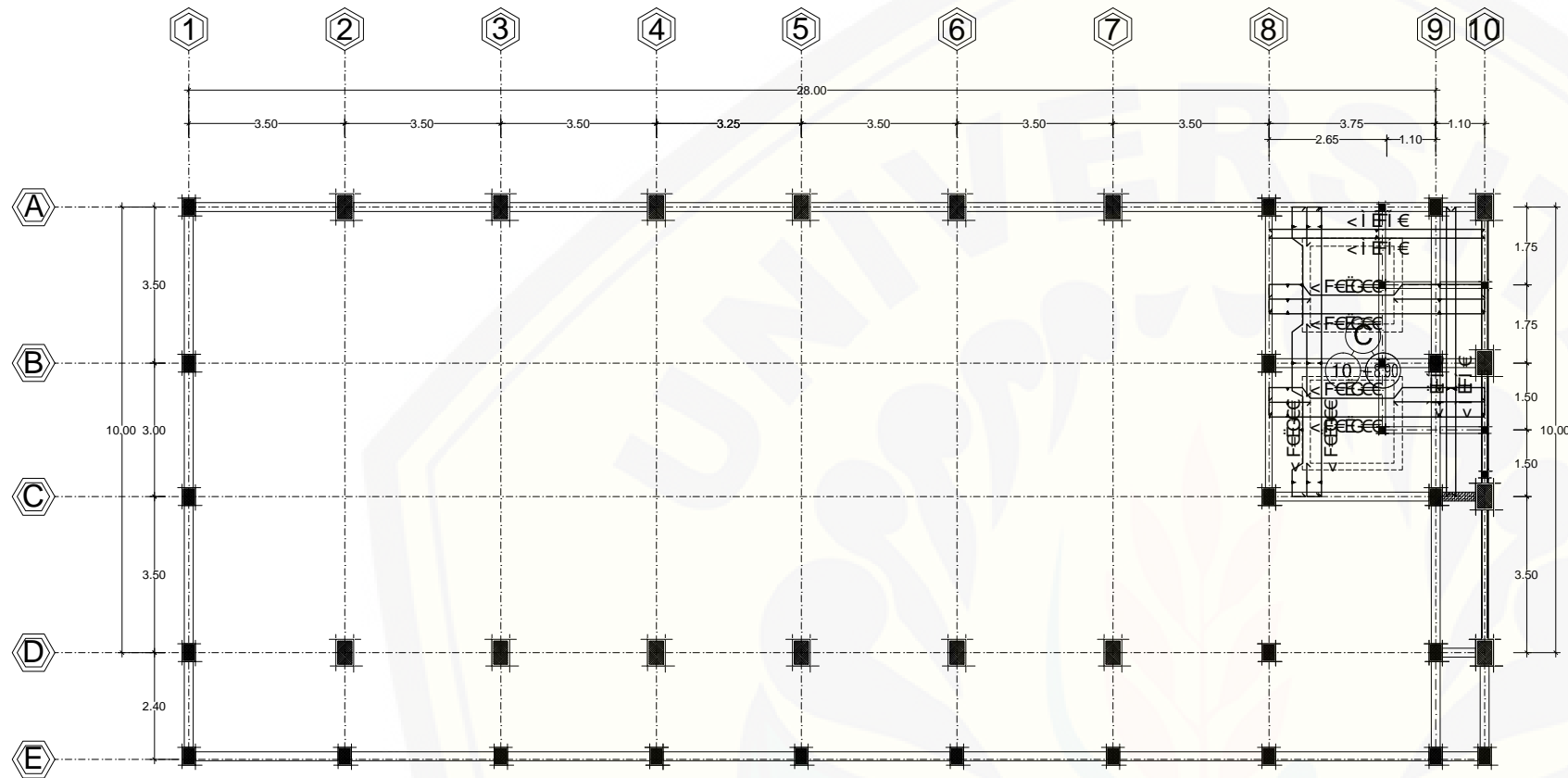

RENCANA PLAT LANTAI TANDON ELEVASI +13.50
SKALA 1 : 150



KEMENTERIAN RISET, TEKNOLOGI
DAN PENDIDIKAN TINGGI
UNIVERSITAS JEMBER
Jl. Kalimantan no. 37 Kampus Tegay Boto Kotak Pos 159
Telp. (0331) 32445, 324446 Fax (0331) - 339029, 337422
JEMBER

KEGIATAN		
SARANA / PRASARANA PENDUKUNG PEMBELAJARAN		
PEKERJAAN		
PEMBANGUNAN GEDUNG AKUNTANSI FAKULTAS EKONOMI (TAHAP 1)		
LOKASI		
UNIVERSITAS JEMBER		
MENGETAHUI / MENYETUJUI	TGL	TANDA TANGAN
PEMBANTU REKTOR II UNIVERSITAS JEMBER		
DR. AKHMAD TOHA, M.Si. NIP. 19571227 198702 1 002		
MENGETAHUI / MENYETUJUI	TGL	TANDA TANGAN
PEJABAT PEMBUAT KOMITMEN UNIVERSITAS JEMBER		
BADERUN, SE NIP. 19630215 198703 1 002		
MENGETAHUI / MENYETUJUI	TGL	TANDA TANGAN
KEPALA BIRO III UNIVERSITAS JEMBER		
Drs. SUGIARTO, S.H., M.M. NIP. 19591220 198003 1 001		
MENGETAHUI / MENYETUJUI	TGL	TANDA TANGAN
DEKAN FAKULTAS EKONOMI UNIVERSITAS JEMBER		
DR. M. FATHORRAZI, M.Si. NIP. 196306 14199002 1 001		
MENGETAHUI / MENYETUJUI	TGL	TANDA TANGAN
KETUA TIM TEKNIS		
Ir. HERNU SUYOSO, M.T. NIP. 19551112 198702 1 001		
KONSULTAN PERENCANA		
Architect - Planner - Construction - Consultant		
PT. DEWI PERMATA MANDIRI		
Kantor : Jl. Langsep Raya No. 02A / 08 Tlp. (0331) 424080 Jember 68111		
. Perencana - Perancang - Pengawas & Manajemen Konstruksi .		
DIGAMBAR	DIPERIKSA	PENANGGUNG JAWAB GAMBAR
SOLEHUJIN ZUHRI, ST. DRAFTER	Ir. PONIMAN TENAGA AHLI STRUKTUR	Ir. SRIWIYONO DIREKTUR UTAMA
JUDUL GAMBAR		SKALA
RENCANA PLAT LANTAI		1 : 150
KODE GAMBAR	NOMOR LEMBAR	JUMLAH LEMBAR
ARS	10	31

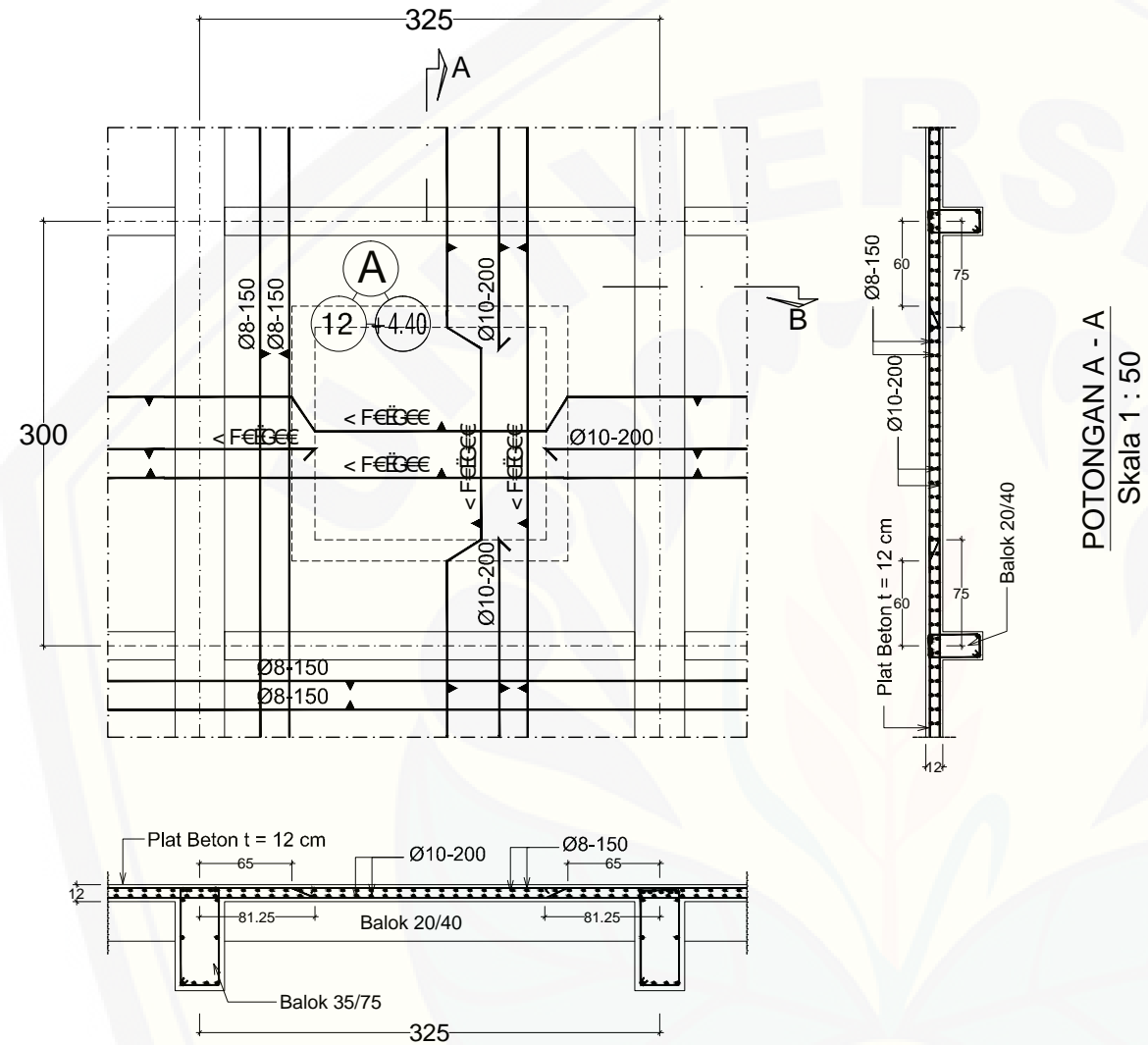

POTONGAN B - B
Skala 1 : 50

POTONGAN A - A
Skala 1 : 50

DETAIL I
SKALA 1 : 50



KEMENTERIAN RISET, TEKNOLOGI
DAN PENDIDIKAN TINGGI
UNIVERSITAS JEMBER
Jl. Kalimantan no. 37 Kampus Tegol Boto Kotak Pos 159
Telp. (0331) 32445, 32446 Fax (0331) - 339029, 337422
JEMBER

KEGIATAN		
SARANA / PRASARANA PENDUKUNG PEMBELAJARAN		
PEKERJAAN		
PEMBANGUNAN GEDUNG AKUNTANSI FAKULTAS EKONOMI (TAHAP 1)		
LOKASI		
UNIVERSITAS JEMBER		
MENGETAHUI / MENYETUJUI	TGL	TANDA TANGAN
PEMBANTU REKTOR II UNIVERSITAS JEMBER DR. AKHMAD TOHA, M.Si. NIP. 19571227 198702 1 002		
MENGETAHUI / MENYETUJUI	TGL	TANDA TANGAN
PEJABAT PEMBUAT KOMITMEN UNIVERSITAS JEMBER BADERUN, SE NIP. 19630215 198703 1 002		
MENGETAHUI / MENYETUJUI	TGL	TANDA TANGAN
KEPALA BIRO III UNIVERSITAS JEMBER Drs. SUGIARTO, S.H., M.M. NIP. 19591220 198003 1 001		
MENGETAHUI / MENYETUJUI	TGL	TANDA TANGAN
DEKAN FAKULTAS EKONOMI UNIVERSITAS JEMBER DR. M. FATHORRAZI, M.Si. NIP. 196306 14199002 1 001		
MENGETAHUI / MENYETUJUI	TGL	TANDA TANGAN
KETUA TIM TEKNIS Ir. HERNU SUYOSO, M.T. NIP. 19551112 198702 1 001		
KONSULTAN PERENCANA		
 Architect - Planner - Construction - Consultant PT. DEWI PERMATA MANDIRI Kantor : Jl. Langsep Raya No. 02A / 08 Tlp. (0331) 424080 Jember 68111 . Perencana - Perancang - Pengawas & Manajemen Konstruksi .		
DIGAMBAR	DIPERIKSA	PENANGGUNG JAWAB GAMBAR
SOLEHUJIN ZUHRI, ST. DRAFTER	Ir. PONIMAN TENAGA AHLI STRUKTUR	Ir. SRIWIYONO DIREKTUR UTAMA
JUDUL GAMBAR		SKALA
DETAIL PLAT LANTAI		1 : 50
KODE GAMBAR	NOMOR LEMBAR	JUMLAH LEMBAR
ARS	11	31

TABEL KOLOM

TYPE KOLOM	K1	K2	KP
POSISI KOLOM	POT A	POT B	POT C
PENAMPANG			
DIMENSI	400 X 600	300 X 400	120 X 120
TULANGAN	16 D 22mm	12 D 16mm	4 Ø 10mm
BEUGEL	Ø 8 - 150	Ø 8 - 150	Ø 8 - 150
TEBAL SELIMUT BETON	25 mm	25 mm	25 mm

TABEL SLOOF

TYPE SLOOF	SF1	SF2	SF3
POSISI SLOOF	POT I-I	POT II-II	POT III-III
PENAMPANG			
DIMENSI	300 X 600	200 X 400	150 X 200
TULANGAN ATAS	4 D 16mm	3 D 16mm	2 D 10mm
TULANGAN TENGAH	2 D 16mm	-	-
TULANGAN BAWAH	4 D 16mm	3 D 16mm	2 D 10mm
BEUGEL	Ø 10 - 150	Ø 10 - 150	Ø 10 - 200
TEBAL SELIMUT BETON	25 mm	25 mm	25 mm



KEMENTERIAN RISET, TEKNOLOGI DAN PENDIDIKAN TINGGI
UNIVERSITAS JEMBER
Jl. Kalimantan no. 37 Kampus Tegol Boto Kotak Pos 159
Telp. (0331) 32445, 324446 Fax (0331) - 339029, 337422
JEMBER

KEGIATAN

SARANA / PRASARANA
PENDUKUNG PEMBELAJARAN

PEKERJAAN

PEMBANGUNAN GEDUNG
AKUNTANSI FAKULTAS EKONOMI
(TAHAP 1)

LOKASI

UNIVERSITAS JEMBER

MENGETAHUI / MENYETUJUI TGL TANDA TANGAN

PEMBANTU REKTOR II
UNIVERSITAS JEMBER

DR. AKHMAD TOHA, M.Si.
NIP. 19571227 198702 1 002

MENGETAHUI / MENYETUJUI TGL TANDA TANGAN

PEJABAT PEMBUAT KOMITMEN
UNIVERSITAS JEMBER

BADERUN, SE
NIP. 19630215 198703 1 002

MENGETAHUI / MENYETUJUI TGL TANDA TANGAN

KEPALA BIRO III
UNIVERSITAS JEMBER

Drs. SUGIARTO, S.H., M.M.
NIP. 19591220 198003 1 001

MENGETAHUI / MENYETUJUI TGL TANDA TANGAN

DEKAN FAKULTAS EKONOMI
UNIVERSITAS JEMBER

DR. M. FATHORRAZI, M.Si.
NIP. 196306 14199002 1 001

MENGETAHUI / MENYETUJUI TGL TANDA TANGAN

KETUA TIM TEKNIS

Ir. HERNU SUYOSO, M.T.
NIP. 19551112 198702 1 001

KONSULTAN PERENCANA

Architect - Planner - Construction - Consultant
PT. DEWI PERMATA MANDIRI
Kantor : Jl. Langsep Raya No. 02A / 08 Tlp. (0331) 424080 Jember 68111
Perencana - Perancang - Pengawas & Manajemen Konstruksi .

DIGAMBAR DIPERIKSA PENANGGUNG JAWAB GAMBAR

SOLEHUDIN ZUHRI, ST
DRAFTER

Ir. PONIMAN
TENAGA AHLI STRUKTUR

Ir. SRWIYONO
DIREKTUR UTAMA

JUDUL GAMBAR SKALA

DETAIL BETON 1:20

KODE GAMBAR NOMOR LEMBAR JUMLAH LEMBAR

STR 16 31

TABEL BALOK

TYPE BALOK	BALOK 35/75		BALOK 20/40		BALOK 20/40 (BALOK RING)
	POT 1 - 1	POT 2 - 2	POT 3 - 3	POT 4 - 4	POT 5 - 5
POSISI BALOK					
PENAMPANG					
DIMENSI	350 X 750	350 X 750	200 X 400	200 X 400	200 X 400
TULANGAN ATAS	7 D 22mm	4 D 22mm	4 D 16mm	2 D 16mm	3 D 16mm
TULANGAN TENGAH	2 D 16mm	2 D 16mm	-	-	-
TULANGAN BAWAH	4 D 22mm	7 D 22mm	2 D 16mm	4 D 16mm	3 D 16mm
BEUGEL	φ 8 - 100	φ 8 - 150	φ 8 - 100	φ 8 - 200	φ 8 - 150
TEBAL SELIMUT BETON	25 mm	25 mm	25 mm	25 mm	25 mm

TABEL BALOK

TYPE BALOK	BALOK 11/20
POSISI BALOK	POT 6 - 6
PENAMPANG	
DIMENSI	110 X 200
TULANGAN ATAS	2 D 16mm
TULANGAN TENGAH	-
TULANGAN BAWAH	2 D 16mm
BEUGEL	φ 10 - 150
TEBAL SELIMUT BETON	25 mm



KEMENTERIAN RISET, TEKNOLOGI DAN PENDIDIKAN TINGGI
UNIVERSITAS JEMBER
Jl. Kalimantan no. 37 Kampus Tegol Boto Kotak Pos 159
Telp. (0331) 32445, 324446 Fax (0331) - 339029, 337422
JEMBER

KEGIATAN		
SARANA / PRASARANA PENDUKUNG PEMBELAJARAN		
PEKERJAAN		
PEMBANGUNAN GEDUNG AKUNTANSI FAKULTAS EKONOMI (TAHAP 1)		
LOKASI		
UNIVERSITAS JEMBER		
MENGETAHUI / MENYETUJUI	TGL	TANDA TANGAN
PEMBANTU REKTOR II UNIVERSITAS JEMBER DR. AKHMAD TOHA, M.Si. NIP. 19571227 198702 1 002		
MENGETAHUI / MENYETUJUI	TGL	TANDA TANGAN
PEJABAT PEMBUAT KOMITMEN UNIVERSITAS JEMBER BADERUN, SE NIP. 19630215 198703 1 002		
MENGETAHUI / MENYETUJUI	TGL	TANDA TANGAN
KEPALA BIRO III UNIVERSITAS JEMBER Drs. SUGIARTO, S.H., M.M. NIP. 19591220 198003 1 001		
MENGETAHUI / MENYETUJUI	TGL	TANDA TANGAN
DEKAN FAKULTAS EKONOMI UNIVERSITAS JEMBER DR. M. FATHORRAZI, M.Si. NIP. 196306 14199002 1 001		
MENGETAHUI / MENYETUJUI	TGL	TANDA TANGAN
KETUA TIM TEKNIS Ir. HERNU SUYOSO, M.T. NIP. 19551112 198702 1 001		
KONSULTAN PERENCANA		
Architect - Planner - Construction - Consultant PT. DEWI PERMATA MANDIRI Kantor : Jl. Langsep Raya No. 02A / 08 Tlp. (0331) 424080 Jember 68111 Perencana - Perancang - Pengawas & Manajemen Konstruksi .		
DIGAMBAR	DIPERIKSA	PENANGGUNG JAWAB GAMBAR
SOLEHUDDIN ZUHRI, ST. DRAFTER	Ir. PONIMAN TENAGA AHLI STRUKTUR	Ir. SRWIYONO, DIREKTUR UTAMA
JUDUL GAMBAR		SKALA
DETAIL BETON		1 : 20
KODE GAMBAR	NOMOR LEMBAR	JUMLAH LEMBAR
STR	17	31

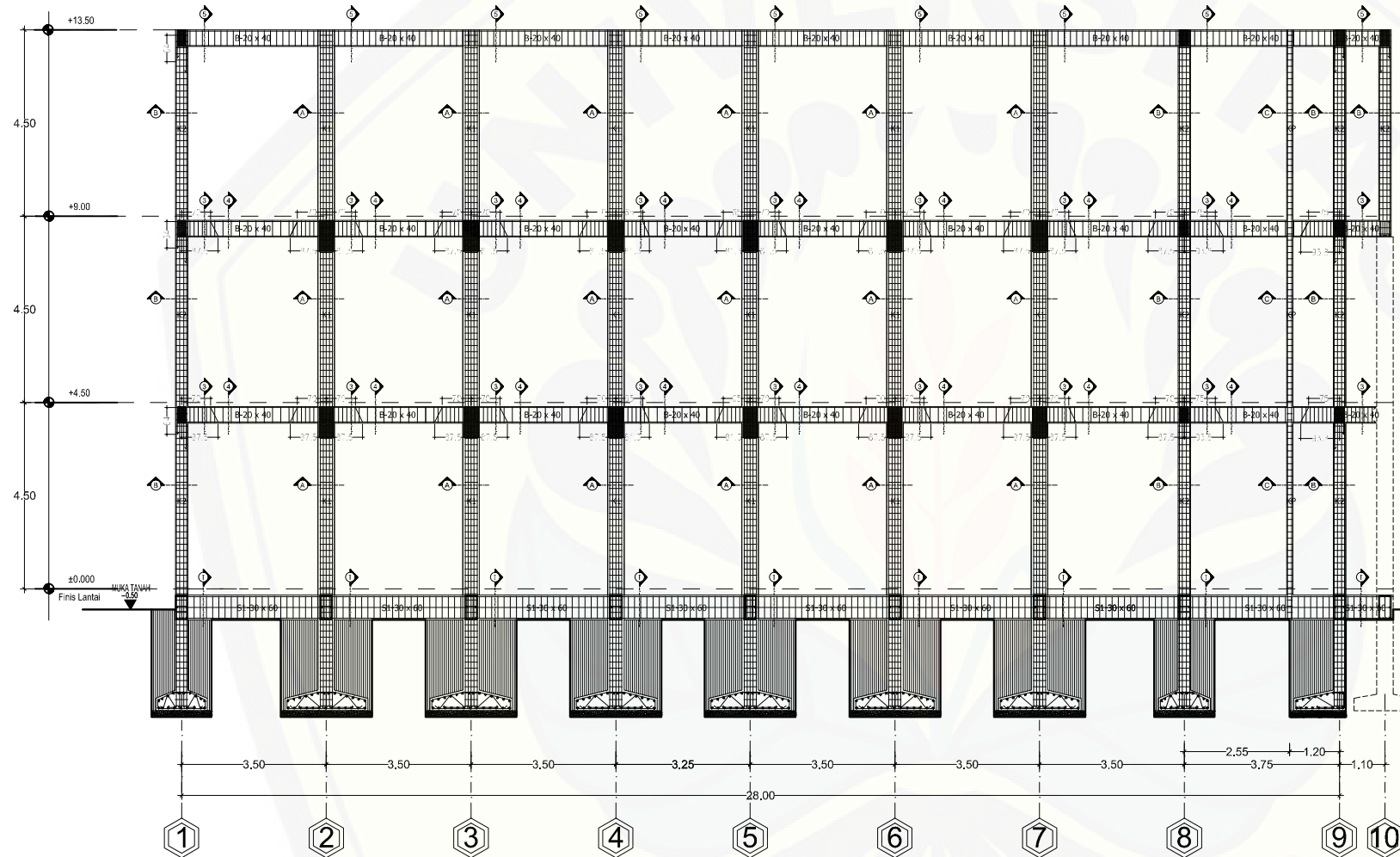

PORTAL AS - A
SKALA 1 : 150



KEMENTERIAN RISET, TEKNOLOGI
DAN PENDIDIKAN TINGGI
UNIVERSITAS JEMBER
Jl. Kalimantan no. 37 Kampus Tegai Boto Kotak Pos 159
Telp. (0331) 32445, 324446 Fax (0331) - 339029, 337422
JEMBER

KEGIATAN

SARANA / PRASARANA
PENDUKUNG PEMBELAJARAN

PEKERJAAN

PEMBANGUNAN GEDUNG
AKUNTANSI FAKULTAS EKONOMI
(TAHAP 1)

LOKASI

UNIVERSITAS JEMBER

MENGETAHUI / MENYETUJUI	TGL	TANDA TANGAN
PEMBANTU REKTOR II UNIVERSITAS JEMBER DR. AKHMAD TOHA, M.Si. NIP. 19571227 198702 1 002		
MENGETAHUI / MENYETUJUI	TGL	TANDA TANGAN
PEJABAT PEMBUAT KOMITMEN UNIVERSITAS JEMBER BADERUN, SE NIP. 19630215 198703 1 002		
MENGETAHUI / MENYETUJUI	TGL	TANDA TANGAN
KEPALA BIRO III UNIVERSITAS JEMBER Drs. SUGIARTO, S.H., M.M. NIP. 19581220 198003 1 001		
MENGETAHUI / MENYETUJUI	TGL	TANDA TANGAN
DEKAN FAKULTAS EKONOMI UNIVERSITAS JEMBER DR. M. FATHORRAZI, M.Si. NIP. 196306 14199002 1 001		
MENGETAHUI / MENYETUJUI	TGL	TANDA TANGAN
KETUA TIM TEKNIS Ir. HERNU SUYOSO, M.T. NIP. 19551112 198702 1 001		

KONSULTAN PERENCANA

Architect - Planner - Construction - Consultant
PT. DEWI PERMATA MANDIRI
Kantor : Jl. Langsep Raya No. 02A / 08 Tlp. (0331) 424080 Jember 68111
. Perencana - Perancang - Pengawas & Manajemen Konstruksi .

DIGAMBAR	DIPERIKSA	PENANGGUNG JAWAB GAMBAR
SOLEHUDIN ZUHRI, ST DRAFTER	Ir. PONIMAN TENAGA AHLI STRUKTUR	Ir. SRIWIYONO DIREKTUR UTAMA
JUDUL GAMBAR		SKALA
PORTAL AS HURUF		1 : 150
KODE GAMBAR	NOMOR LEMBAR	JUMLAH LEMBAR
STR	18	31

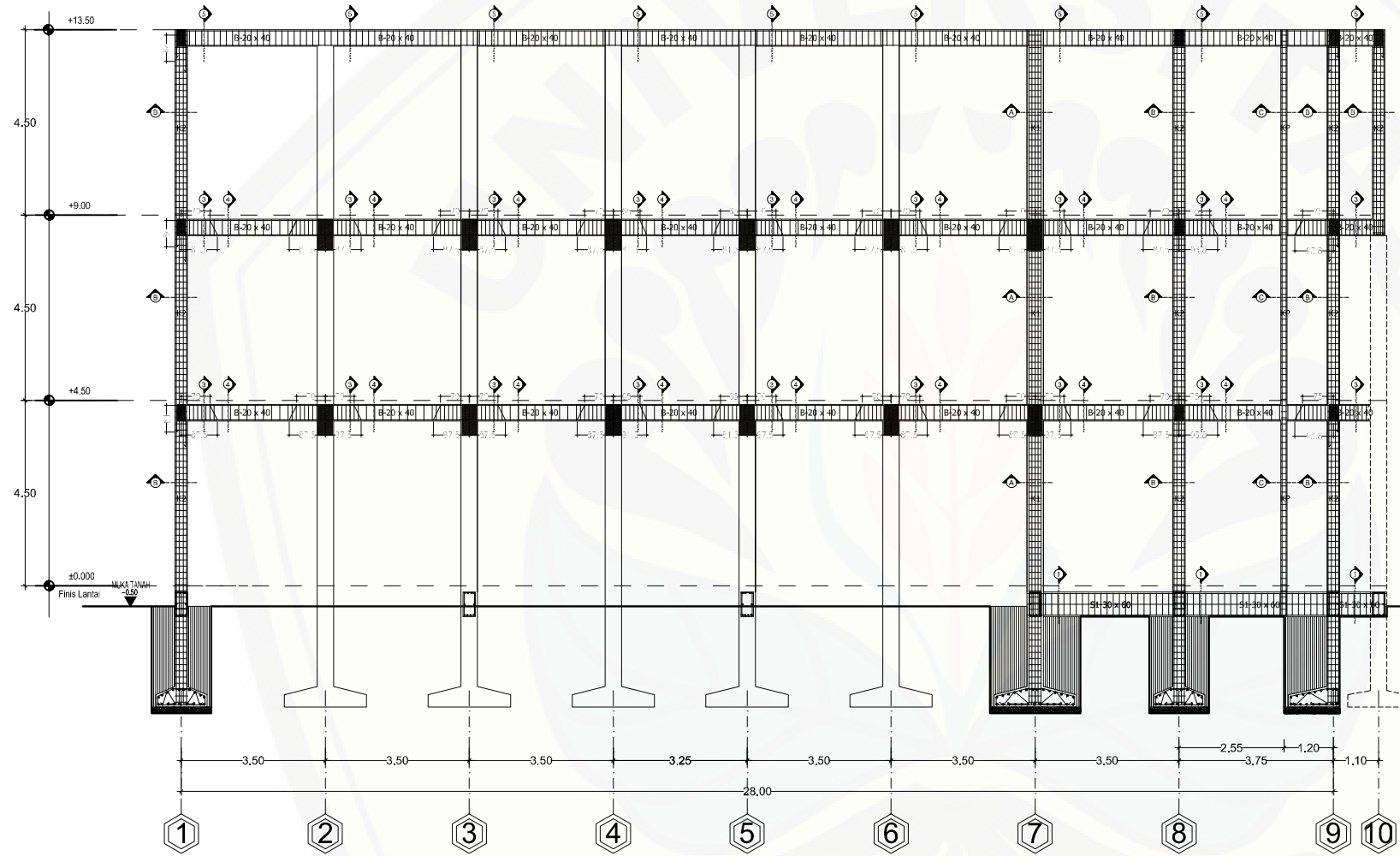

PORTAL AS - B
SKALA 1 : 150

KEMENTERIAN RISET, TEKNOLOGI
DAN PENDIDIKAN TINGGI
UNIVERSITAS JEMBER
Jl. Kalimantan no. 37 Kampus Tegai Boto Kotak Pos 159
Telp. (0331) 32445, 324446 Fax (0331) - 339029, 337422
JEMBER

KEGIATAN
**SARANA / PRASARANA
PENDUKUNG PEMBELAJARAN**

PEKERJAAN
**PEMBANGUNAN GEDUNG
AKUNTANSI FAKULTAS EKONOMI
(TAHAP 1)**

LOKASI
UNIVERSITAS JEMBER

MENGETAHUI / MENYETUJUI	TGL	TANDA TANGAN
PEMBANTU REKTOR II UNIVERSITAS JEMBER DR. AKHMAD TOHA, M.Si. NIP. 19571227 198702 1 002		
MENGETAHUI / MENYETUJUI	TGL	TANDA TANGAN
PEJABAT PEMBUAT KOMITMEN UNIVERSITAS JEMBER BADERUN, SE NIP. 19630215 198703 1 002		
MENGETAHUI / MENYETUJUI	TGL	TANDA TANGAN
KEPALA BIRO III UNIVERSITAS JEMBER Drs. SUGIARTO, S.H., M.M. NIP. 19591220 198003 1 001		
MENGETAHUI / MENYETUJUI	TGL	TANDA TANGAN
DEKAN FAKULTAS EKONOMI UNIVERSITAS JEMBER DR. M. FATHORRAZI, M.Si. NIP. 196306 14199002 1 001		
MENGETAHUI / MENYETUJUI	TGL	TANDA TANGAN
KETUA TIM TEKNIS Ir. HERNU SUYOSO, M.T. NIP. 19551112 198702 1 001		

KONSULTAN PERENCANA
Architect - Planner - Construction - Consultant
PT. DEWI PERMATA MANDIRI
Kantor : Jl. Langsep Raya No. 02A / 08 Tlp. (0331) 424080 Jember 68111
. Perencana - Perancang - Pengawas & Manajemen Konstruksi .

DIGAMBAR	DIPERIKSA	PENANGGUNG JAWAB GAMBAR
SOLEHUDIN ZUHRU, ST DRAFTER	Ir. PONIMAN TENAGA AHLI STRUKTUR	Ir. SRIWIYONO DIREKTUR UTAMA
JUDUL GAMBAR		SKALA
PORTAL AS HURUF		1 : 150
KODE GAMBAR	NOMOR LEMBAR	JUMLAH LEMBAR
STR	19	31

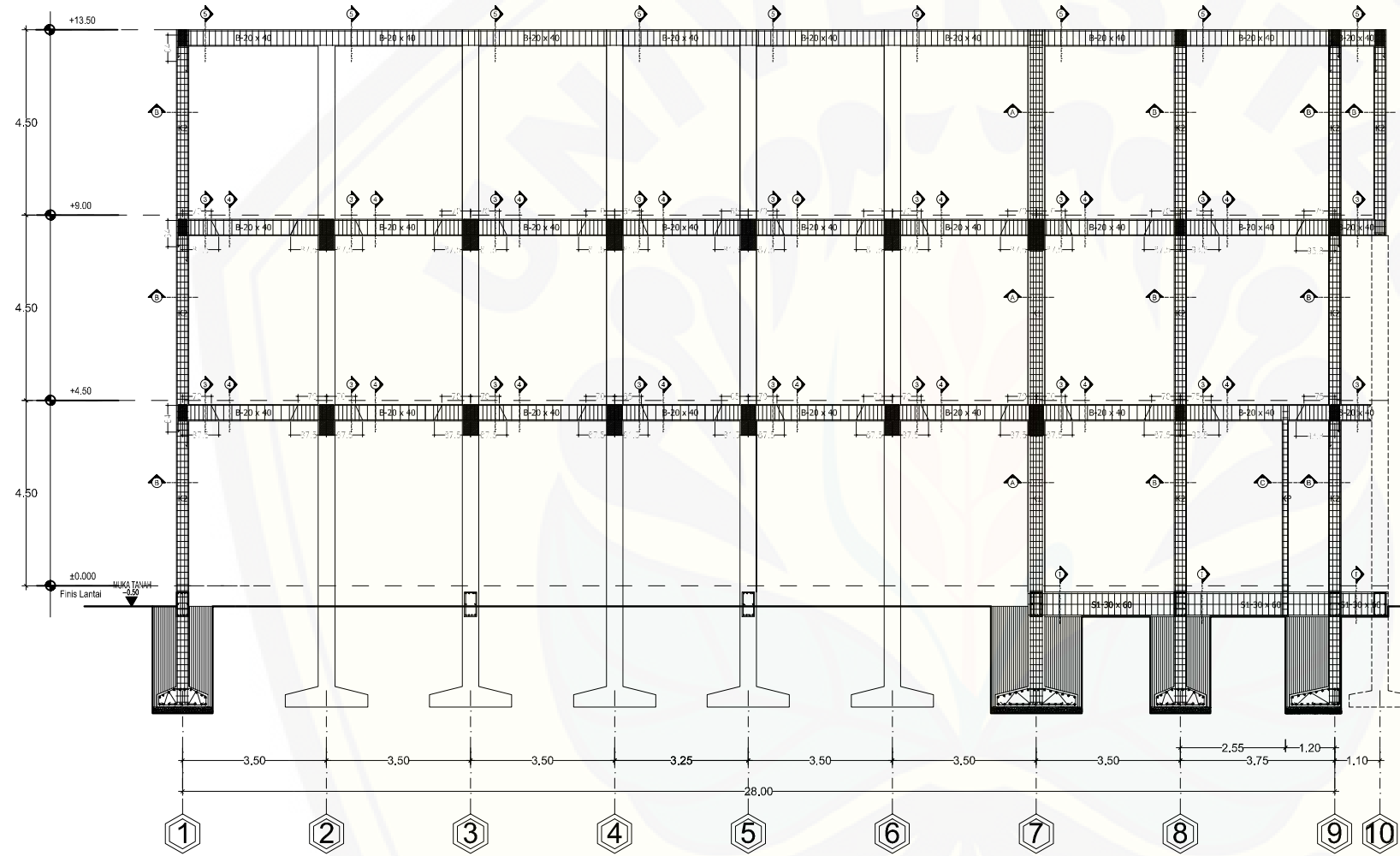

PORTAL AS - C
SKALA 1 : 150



KEMENTERIAN RISET, TEKNOLOGI
DAN PENDIDIKAN TINGGI
UNIVERSITAS JEMBER
Jl. Kalimantan no. 37 Kampus Tegai Boto Kotak Pos 159
Telp. (0331) 32445, 324446 Fax (0331) - 339029, 337422
JEMBER

KEGIATAN		
SARANA / PRASARANA PENDUKUNG PEMBELAJARAN		
PEKERJAAN		
PEMBANGUNAN GEDUNG AKUNTANSI FAKULTAS EKONOMI (TAHAP 1)		
LOKASI		
UNIVERSITAS JEMBER		
MENGETAHUI / MENYETUJUI	TGL	TANDA TANGAN
PEMBANTU REKTOR II UNIVERSITAS JEMBER DR. AKHMAD TOHA, M.Si. NIP. 19571227 198702 1 002		
MENGETAHUI / MENYETUJUI	TGL	TANDA TANGAN
PEJABAT PEMBUAT KOMITMEN UNIVERSITAS JEMBER BADERUN, SE NIP. 19630215 198703 1 002		
MENGETAHUI / MENYETUJUI	TGL	TANDA TANGAN
KEPALA BIRO III UNIVERSITAS JEMBER Drs. SUGIARTO, S.H., M.M NIP. 19591220 198003 1 001		
MENGETAHUI / MENYETUJUI	TGL	TANDA TANGAN
DEKAN FAKULTAS EKONOMI UNIVERSITAS JEMBER DR. M. FATHORRAZI, M.Si NIP. 196306 14199002 1 001		
MENGETAHUI / MENYETUJUI	TGL	TANDA TANGAN
KETUA TIM TEKNIS Ir. HERNU SUYOSO, M.T. NIP. 19551112 198702 1 001		
KONSULTAN PERENCANA		
 Architect - Planner - Construction - Consultant PT. DEWI PERMATA MANDIRI Kantor : Jl. Langsep Raya No. 02A / 08 Tlp. (0331) 424080 Jember 68111 . Perencana - Perancang - Pengawas & Manajemen Konstruksi .		
DIGAMBAR	DIPERIKSA	PENANGGUNG JAWAB GAMBAR
SOLEHUDIN ZUHRI, ST DRAFTER	Ir. PONIMAN TENAGA AHLI STRUKTUR	Ir. SRIWIYONO DIREKTUR UTAMA
JUDUL GAMBAR		SKALA
PORTAL AS HURUF		1 : 150
KODE GAMBAR	NOMOR LEMBAR	JUMLAH LEMBAR
STR	20	31

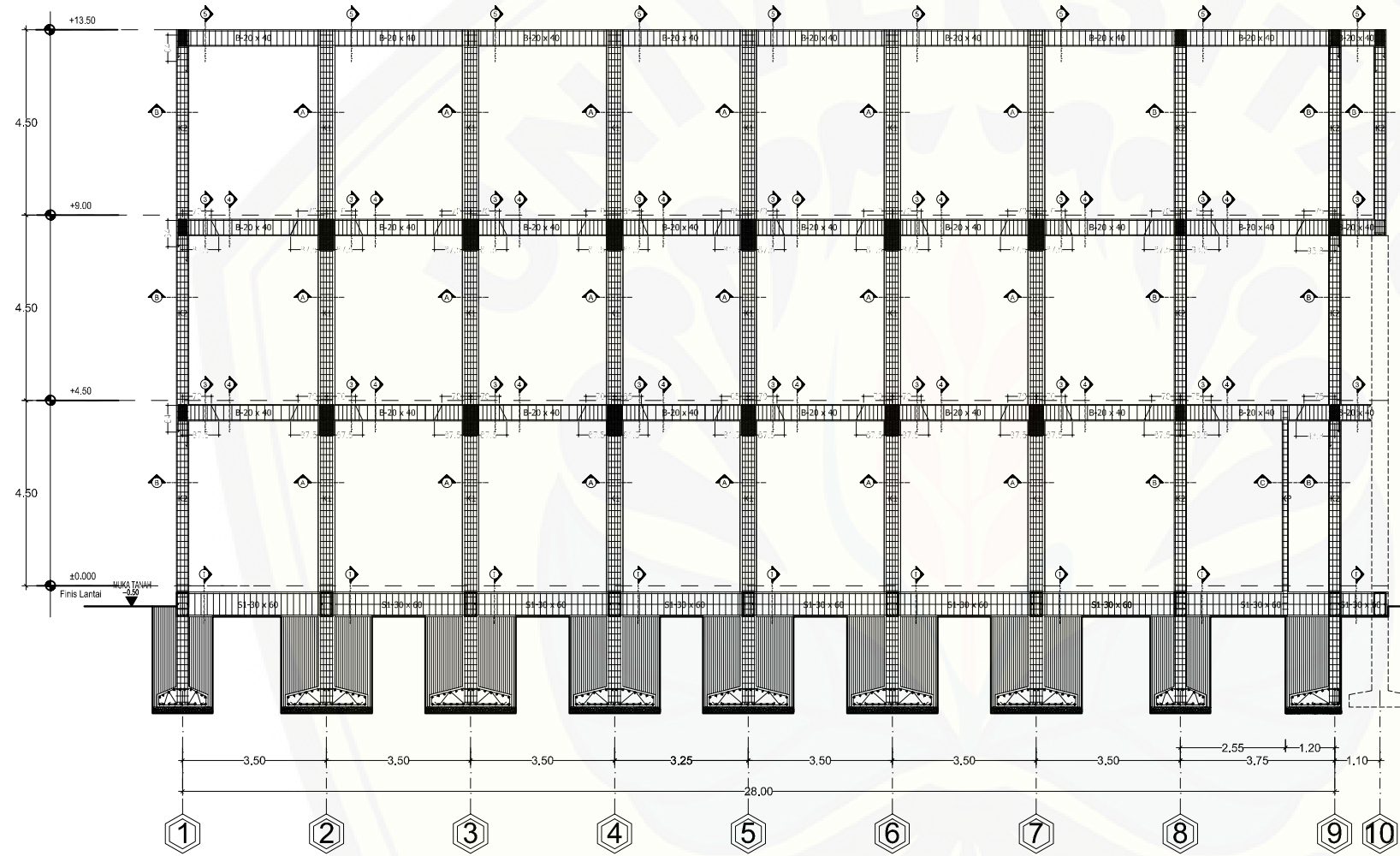

PORTAL AS - D
SKALA 1 : 150

KEMENTERIAN RISET, TEKNOLOGI DAN PENDIDIKAN TINGGI
UNIVERSITAS JEMBER
Jl. Kalimantan no. 37 Kampus Tegai Boto Kotak Pos 159
Telp. (0331) 32445, 324446 Fax (0331) - 339029, 337422
JEMBER

KEGIATAN
**SARANA / PRASARANA
PENDUKUNG PEMBELAJARAN**

PEKERJAAN
**PEMBANGUNAN GEDUNG
AKUNTANSI FAKULTAS EKONOMI
(TAHAP 1)**

LOKASI
UNIVERSITAS JEMBER

MENGETAHUI / MENYETUJUI	TGL	TANDA TANGAN
PEMBANTU REKTOR II UNIVERSITAS JEMBER DR. AKHMAD TOHA, M.Si. NIP. 19571227 198702 1 002		
MENGETAHUI / MENYETUJUI	TGL	TANDA TANGAN
PEJABAT PEMBUAT KOMITMEN UNIVERSITAS JEMBER BADERUN, SE NIP. 19630215 198703 1 002		
MENGETAHUI / MENYETUJUI	TGL	TANDA TANGAN
KEPALA BIRO III UNIVERSITAS JEMBER Drs. SUGIARTO, S.H., M.M. NIP. 19591220 198003 1 001		
MENGETAHUI / MENYETUJUI	TGL	TANDA TANGAN
DEKAN FAKULTAS EKONOMI UNIVERSITAS JEMBER DR. M. FATHORRAZI, M.Si NIP. 196306 14199002 1 001		
MENGETAHUI / MENYETUJUI	TGL	TANDA TANGAN
KETUA TIM TEKNIS Ir. HERNU SUYOSO, M.T. NIP. 19551112 198702 1 001		

KONSULTAN PERENCANA

Architect - Planner - Construction - Consultant
PT. DEWI PERMATA MANDIRI
Kantor : Jl. Langsep Raya No. 02A / 08 Tlp. (0331) 424080 Jember 68111
. Perencana - Perancang - Pengawas & Manajemen Konstruksi .

DIGAMBAR	DIPERIKSA	PENANGGUNG JAWAB GAMBAR
SOLEHUDIN ZUHRI, ST DRAFTER	Ir. PONIMAN TENAGA AHLI STRUKTUR	Ir. SRIWIYONO DIREKTUR UTAMA
JUDUL GAMBAR		SKALA
PORTAL AS HURUF		1 : 150
KODE GAMBAR	NOMOR LEMBAR	JUMLAH LEMBAR
STR	21	31

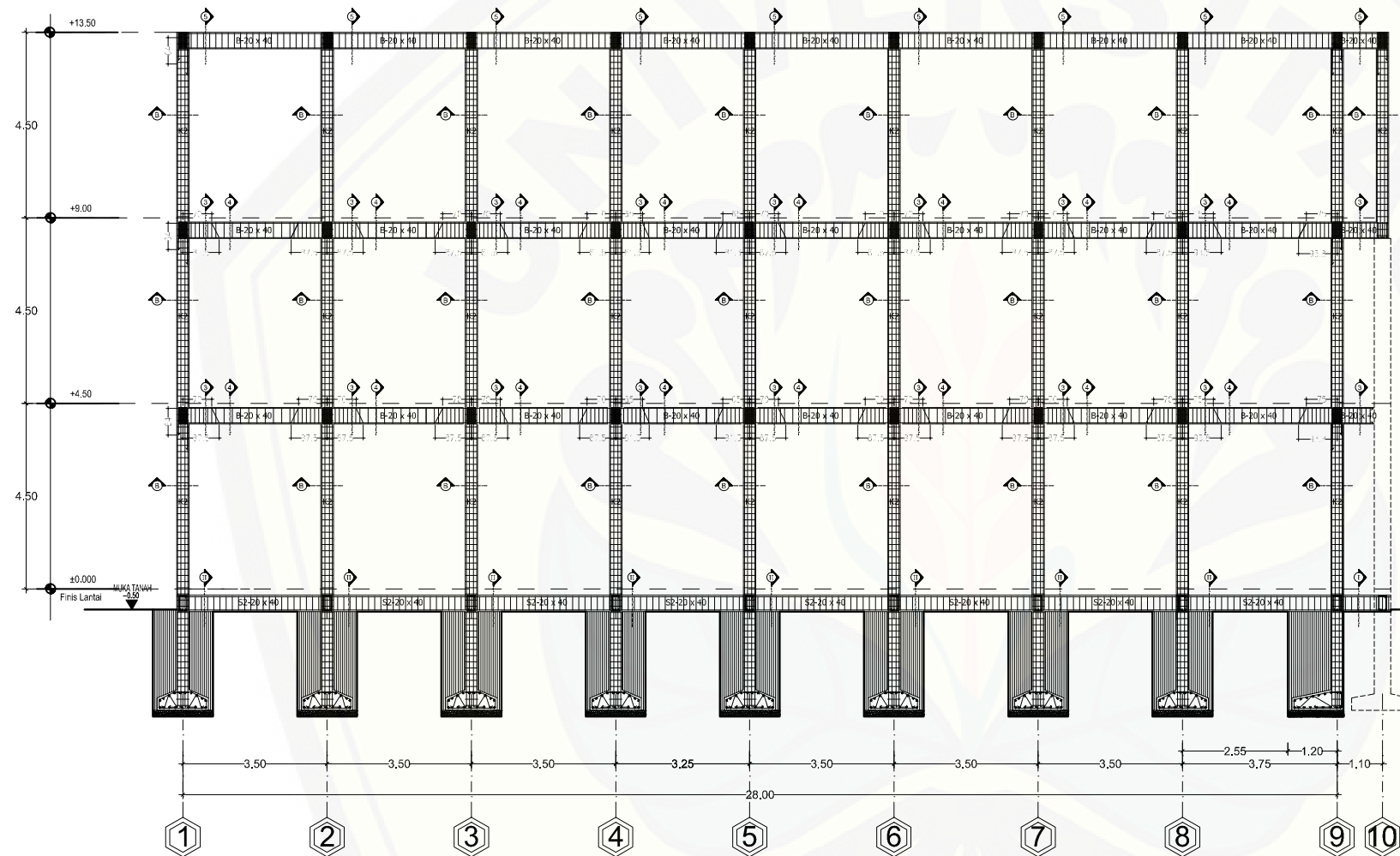

PORTAL AS - E
SKALA 1 : 150



KEMENTERIAN RISET, TEKNOLOGI
DAN PENDIDIKAN TINGGI
UNIVERSITAS JEMBER
Jl. Kalimantan no. 37 Kampus Tegai Boto Kotak Pos 159
Telp. (0331) 32445, 324446 Fax (0331) - 339029, 337422
JEMBER

KEGIATAN

SARANA / PRASARANA
PENDUKUNG PEMBELAJARAN

PEKERJAAN

PEMBANGUNAN GEDUNG
AKUNTANSI FAKULTAS EKONOMI
(TAHAP 1)

LOKASI

UNIVERSITAS JEMBER

MENGETAHUI / MENYETUJUI	TGL	TANDA TANGAN
PEMBANTU REKTOR II UNIVERSITAS JEMBER DR. AKHMAD TOHA, M.Si. NIP. 19571227 198702 1 002		
MENGETAHUI / MENYETUJUI	TGL	TANDA TANGAN
PEJABAT PEMBUAT KOMITMEN UNIVERSITAS JEMBER BADERUN, SE NIP. 19630215 198703 1 002		
MENGETAHUI / MENYETUJUI	TGL	TANDA TANGAN
KEPALA BIRO III UNIVERSITAS JEMBER Drs. SUGIARTO, S.H., M.M. NIP. 19591220 198003 1 001		
MENGETAHUI / MENYETUJUI	TGL	TANDA TANGAN
DEKAN FAKULTAS EKONOMI UNIVERSITAS JEMBER DR. M. FATHORRAZI, M.Si NIP. 196306 14199002 1 001		
MENGETAHUI / MENYETUJUI	TGL	TANDA TANGAN
KETUA TIM TEKNIS Ir. HERNU SUYOSO, M.T. NIP. 19551112 198702 1 001		

KONSULTAN PERENCANA

Architect - Planner - Construction - Consultant
PT. DEWI PERMATA MANDIRI
Kantor : Jl. Langsep Raya No. 02A / 08 Tlp. (0331) 424080 Jember 68111
. Perencana - Perancang - Pengawas & Manajemen Konstruksi .

DIGAMBAR	DIPERIKSA	PENANGGUNG JAWAB GAMBAR
SOLEHUDIN ZUHRI, ST DRAFTER	Ir. PONIMAN TENAGA AHLI STRUKTUR	Ir. SRIWIYONO DIREKTUR UTAMA
JUDUL GAMBAR		SKALA
PORTAL AS HURUF		1 : 150
KODE GAMBAR	NOMOR LEMBAR	JUMLAH LEMBAR
STR	22	31

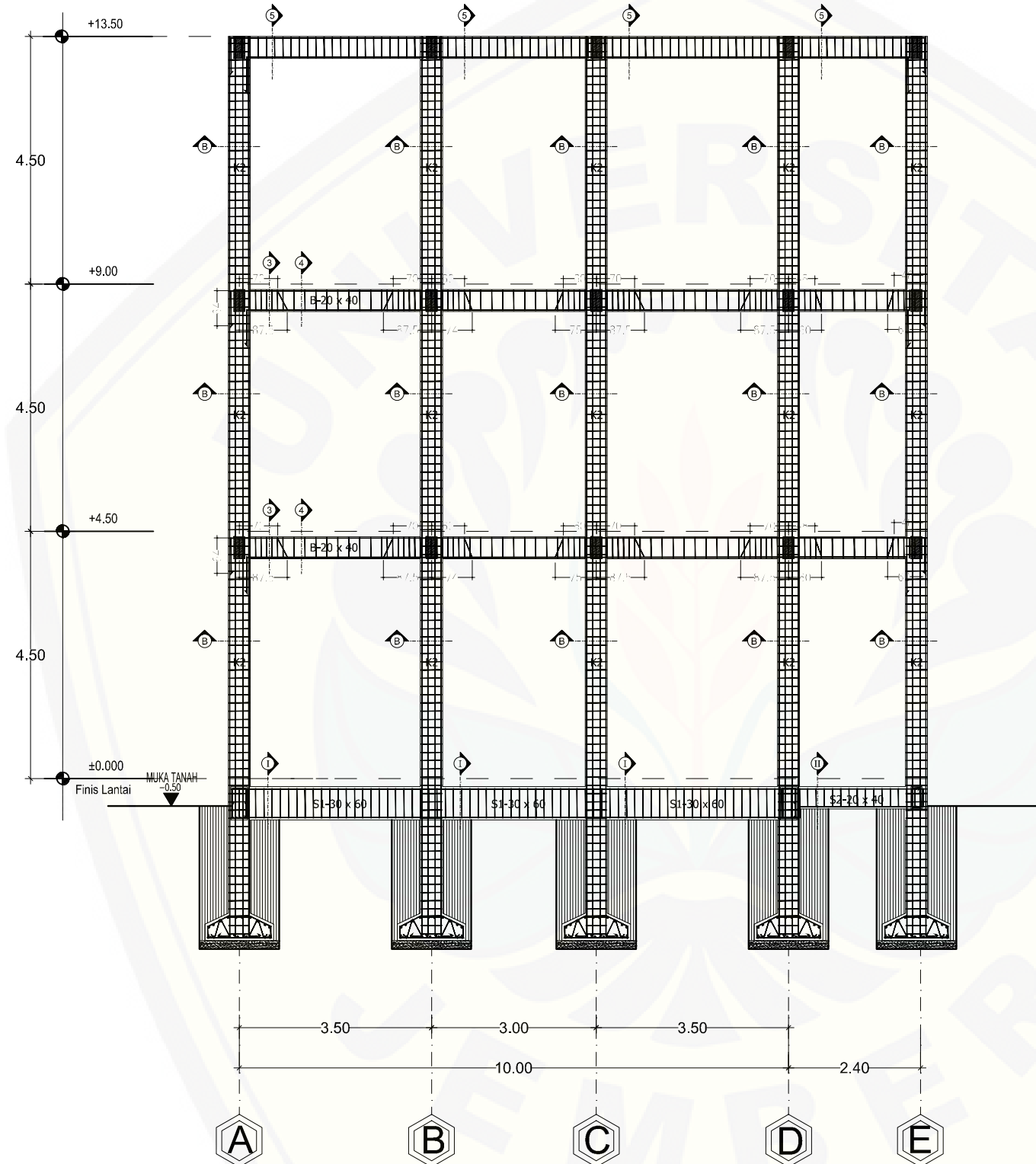

PORTAL AS - 1
SKALA 1 : 150



KEMENTERIAN RISET, TEKNOLOGI
DAN PENDIDIKAN TINGGI
UNIVERSITAS JEMBER
Jl. Kalimantan no. 37 Kampus Tegai Boto Kotak Pos 159
Telp. (0331) 32445, 324446 Fax (0331) - 339029, 337422
JEMBER

KEGIATAN		
SARANA / PRASARANA PENDUKUNG PEMBELAJARAN		
PEKERJAAN PEMBANGUNAN GEDUNG AKUNTANSI FAKULTAS EKONOMI (TAHAP 1)		
LOKASI UNIVERSITAS JEMBER		
MENGETAHUI / MENYETUJUI	TGL	TANDA TANGAN
PEMBANTU REKTOR II UNIVERSITAS JEMBER DR. AKHMAD TOHA, M.Si. NIP. 19571227 198702 1 002		
MENGETAHUI / MENYETUJUI	TGL	TANDA TANGAN
PEJABAT PEMBUAT KOMITMEN UNIVERSITAS JEMBER BADERUN, SE NIP. 19630215 198703 1 002		
MENGETAHUI / MENYETUJUI	TGL	TANDA TANGAN
KEPALA BIRO III UNIVERSITAS JEMBER Drs. SUGIARTO, S.H., M.M. NIP. 19581220 198003 1 001		
MENGETAHUI / MENYETUJUI	TGL	TANDA TANGAN
DEKAN FAKULTAS EKONOMI UNIVERSITAS JEMBER DR. M. FATHORRAZI, M.Si NIP. 196306 14199002 1 001		
MENGETAHUI / MENYETUJUI	TGL	TANDA TANGAN
KETUA TIM TEKNIS Ir. HERNU SUYOSO, M.T. NIP. 19551112 198702 1 001		
KONSULTAN PERENCANA		
 Architect - Planner - Construction - Consultant PT. DEWI PERMATA MANDIRI Kantor : Jl. Langsep Raya No. 02A / 08 Tlp. (0331) 424080 Jember 68111 . Perencana - Perancang - Pengawas & Manajemen Konstruksi .		
DIGAMBAR	DIPERIKSA	PENANGGUNG JAWAB GAMBAR
SOLEHUDIN ZUHRI, ST DRAFTER	Ir. PONIMAN TENAGA AHLI STRUKTUR	Ir. SRIWIYONO DIREKTUR UTAMA
JUDUL GAMBAR		SKALA
PORTAL AS ANGKA		1 : 150
KODE GAMBAR	NOMOR LEMBAR	JUMLAH LEMBAR
STR	23	31

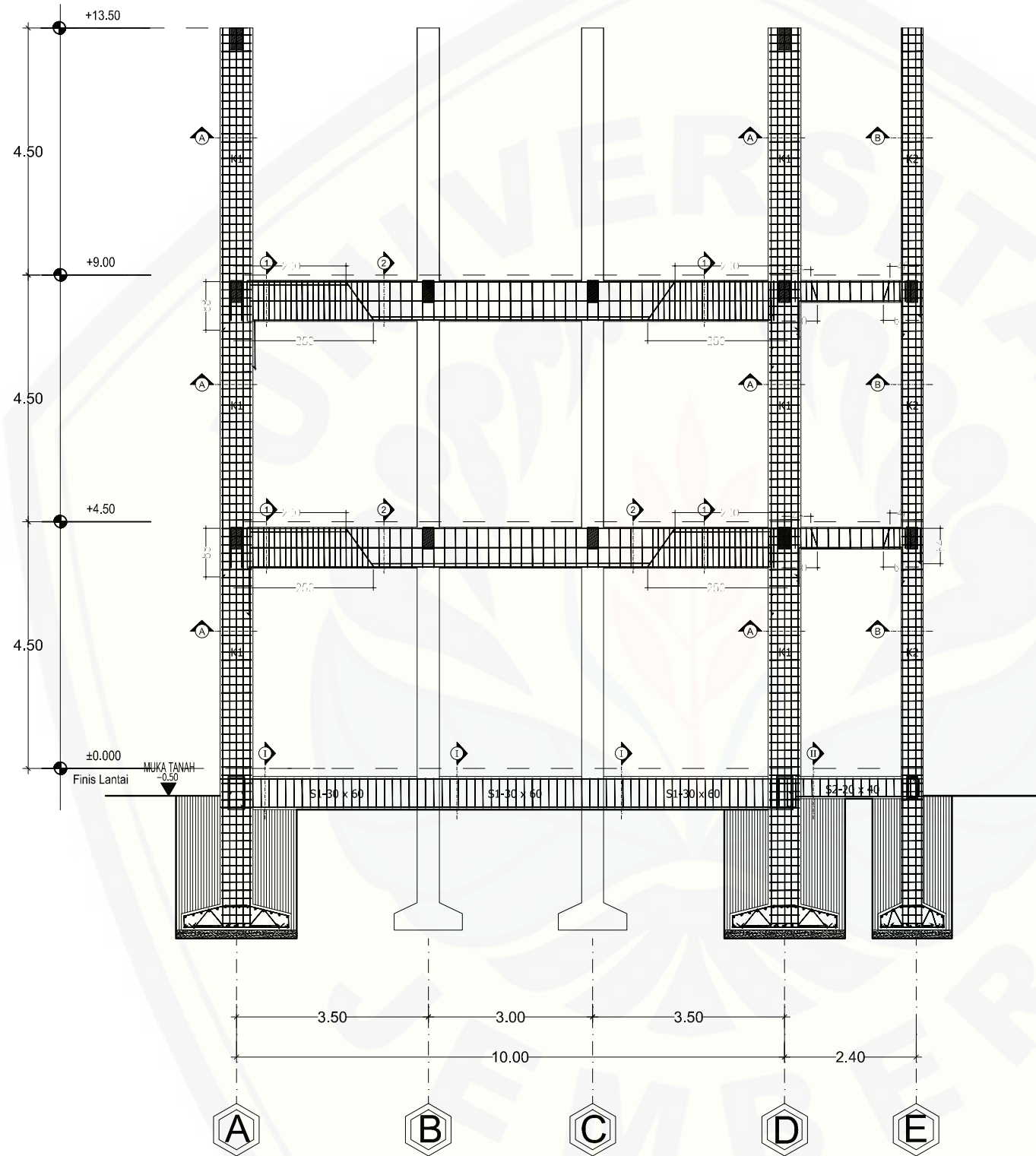

PORTAL AS - 3.5 & 7
SKALA 1 : 150



KEMENTERIAN RISET, TEKNOLOGI
DAN PENDIDIKAN TINGGI
UNIVERSITAS JEMBER
Jl. Kalimantan no. 37 Kampus Tegai Boto Kotak Pos 159
Telp. (0331) 32445, 324446 Fax (0331) - 339029, 337422
JEMBER

KEGIATAN

SARANA / PRASARANA
PENDUKUNG PEMBELAJARAN

PEKERJAAN

PEMBANGUNAN GEDUNG
AKUNTANSI FAKULTAS EKONOMI
(TAHAP 1)

LOKASI

UNIVERSITAS JEMBER

MENGETAHUI / MENYETUJUI	TGL	TANDA TANGAN
PEMBANTU REKTOR II UNIVERSITAS JEMBER DR. AKHMAD TOHA, M.Si. NIP. 19571227 198702 1 002		
MENGETAHUI / MENYETUJUI	TGL	TANDA TANGAN
PEJABAT PEMBUAT KOMITMEN UNIVERSITAS JEMBER BADERUN, SE NIP. 19630215 198703 1 002		
MENGETAHUI / MENYETUJUI	TGL	TANDA TANGAN
KEPALA BIRO III UNIVERSITAS JEMBER Drs. SUGIARTO, S.H., M.M. NIP. 19591220 198003 1 001		
MENGETAHUI / MENYETUJUI	TGL	TANDA TANGAN
DEKAN FAKULTAS EKONOMI UNIVERSITAS JEMBER DR. M. FATHORRAZI, M.Si NIP. 196306 14199002 1 001		
MENGETAHUI / MENYETUJUI	TGL	TANDA TANGAN
KETUA TIM TEKNIS Ir. HERNU SUYOSO, M.T. NIP. 19551112 198702 1 001		

KONSULTAN PERENCANA

Architect - Planner - Construction - Consultant
PT. DEWI PERMATA MANDIRI
Kantor : Jl. Langsep Raya No. 02A / 08 Tlp. (0331) 424080 Jember 68111
. Perencana - Perancang - Pengawas & Manajemen Konstruksi .

DIGAMBAR	DIPERIKSA	PENANGGUNG JAWAB GAMBAR
SOLEHUDIN ZUHRI, ST DRAFTER	Ir. FONIMAN TENAGA AHLI STRUKTUR	Ir. SRIWIYONO DIREKTUR UTAMA
JUDUL GAMBAR		SKALA
PORTAL AS ANGKA		1 : 150
KODE GAMBAR	NOMOR LEMBAR	JUMLAH LEMBAR
STR	25	31

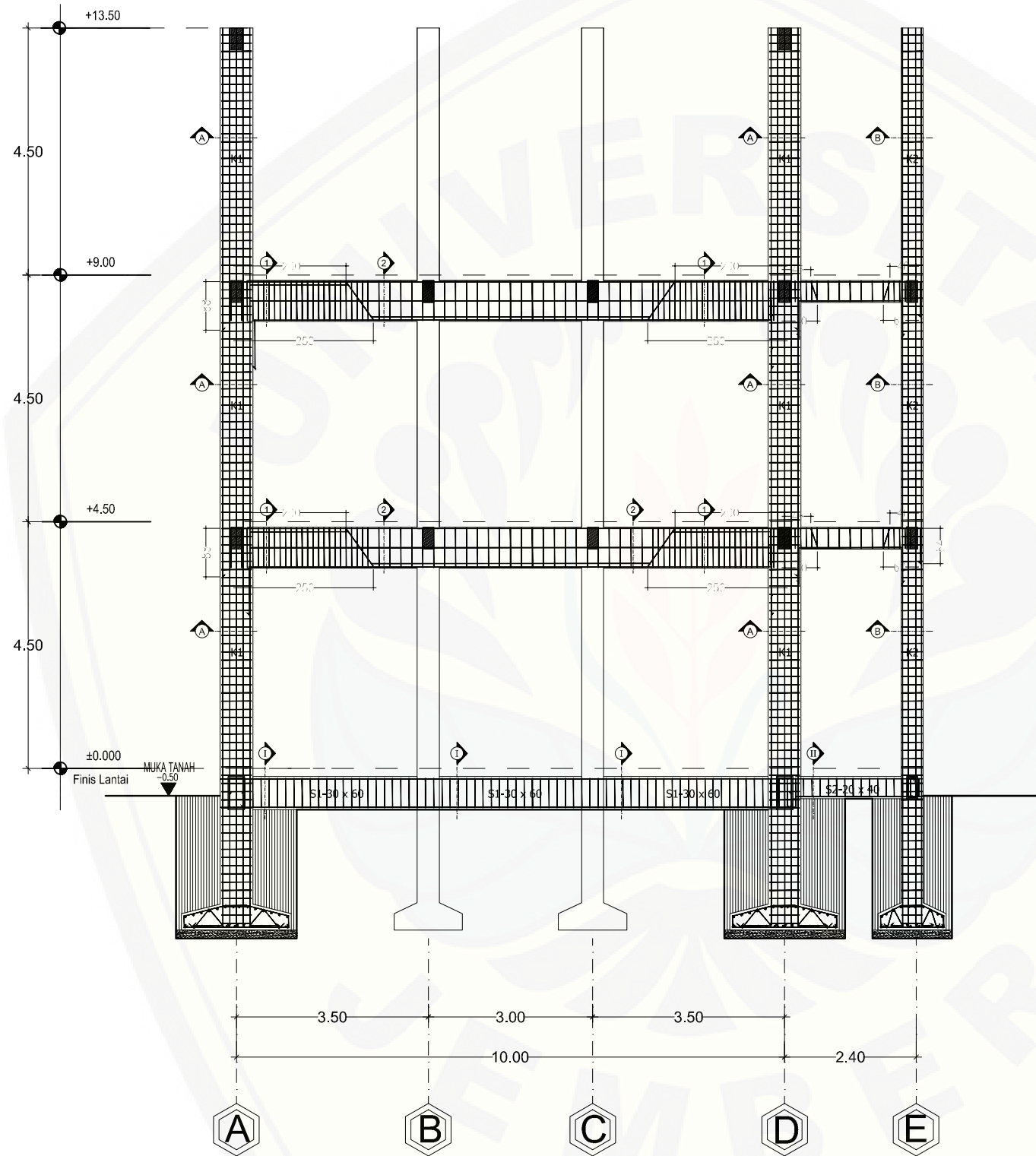

PORTAL AS - 3.5 & 7
SKALA 1 : 150



KEMENTERIAN RISET, TEKNOLOGI
DAN PENDIDIKAN TINGGI
UNIVERSITAS JEMBER
Jl. Kalimantan no. 37 Kampus Tegai Boto Kotak Pos 159
Telp. (0331) 32445, 324446 Fax (0331) - 339029, 337422
JEMBER

KEGIATAN		
SARANA / PRASARANA PENDUKUNG PEMBELAJARAN		
PEKERJAAN		
PEMBANGUNAN GEDUNG AKUNTANSI FAKULTAS EKONOMI (TAHAP 1)		
LOKASI		
UNIVERSITAS JEMBER		
MENGETAHUI / MENYETUJUI	TGL	TANDA TANGAN
PEMBANTU REKTOR II UNIVERSITAS JEMBER		
DR. AKHMAD TOHA, M.Si. NIP. 19571227 198702 1 002		
MENGETAHUI / MENYETUJUI	TGL	TANDA TANGAN
PEJABAT PEMBUAT KOMITMEN UNIVERSITAS JEMBER		
BADERUN, SE NIP. 19630215 198703 1 002		
MENGETAHUI / MENYETUJUI	TGL	TANDA TANGAN
KEPALA BIRO III UNIVERSITAS JEMBER		
Drs. SUGIARTO, S.H., M.M. NIP. 19591220 198003 1 001		
MENGETAHUI / MENYETUJUI	TGL	TANDA TANGAN
DEKAN FAKULTAS EKONOMI UNIVERSITAS JEMBER		
DR. M. FATHORRAZI, M.Si NIP. 196306 14199002 1 001		
MENGETAHUI / MENYETUJUI	TGL	TANDA TANGAN
KETUA TIM TEKNIS		
Ir. HERNU SUYOSO, M.T. NIP. 19551112 198702 1 001		
KONSULTAN PERENCANA		
Architect - Planner - Construction - Consultant		
 PT. DEWI PERMATA MANDIRI Kantor : Jl. Langsep Raya No. 02A / 08 Tlp. (0331) 424080 Jember 68111 . Perencana - Perancang - Pengawas & Manajemen Konstruksi .		
DIGAMBAR	DIPERIKSA	PENANGGUNG JAWAB GAMBAR
SOLEHUDIN ZUHRU, ST DRAFTER	Ir. FONIMAN TENAGA AHLI STRUKTUR	Ir. SRIWIYONO DIREKTUR UTAMA
JUDUL GAMBAR		SKALA
PORTAL AS ANGKA		1 : 150
KODE GAMBAR	NOMOR LEMBAR	JUMLAH LEMBAR
STR	25	31

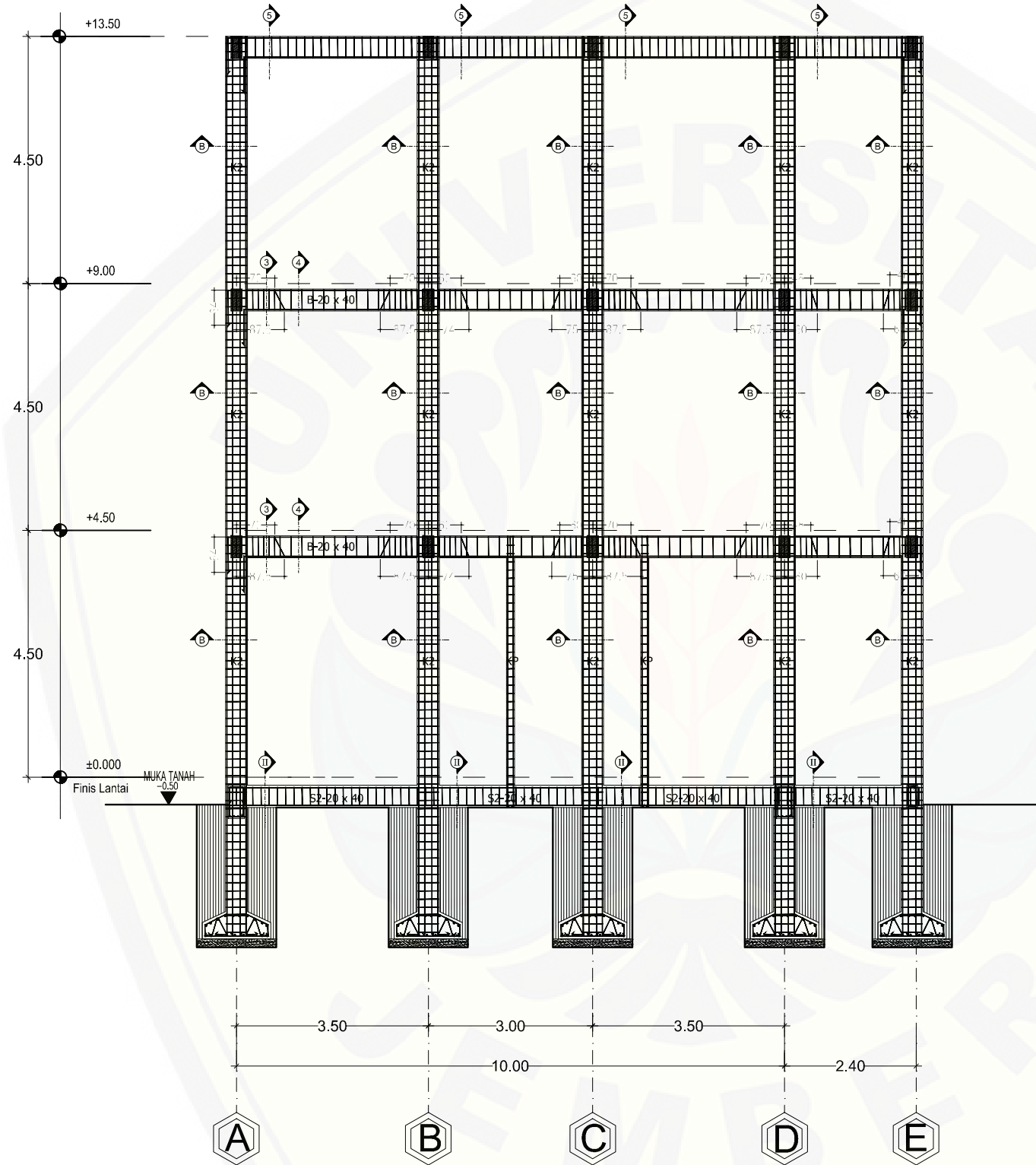

PORTAL AS - 8
SKALA 1 : 150



KEMENTERIAN RISET, TEKNOLOGI
DAN PENDIDIKAN TINGGI
UNIVERSITAS JEMBER
Jl. Kalimantan no. 37 Kampus Tegai Boto Kotak Pos 159
Telp. (0331) 32445, 324446 Fax (0331) - 339029, 337422
JEMBER

KEGIATAN		
SARANA / PRASARANA PENDUKUNG PEMBELAJARAN		
PEKERJAAN		
PEMBANGUNAN GEDUNG AKUNTANSI FAKULTAS EKONOMI (TAHAP 1)		
LOKASI		
UNIVERSITAS JEMBER		
MENGETAHUI / MENYETUJUI	TGL	TANDA TANGAN
PEMBANTU REKTOR II UNIVERSITAS JEMBER		
DR. AKHMAD TOHA, M.Si. NIP. 19571227 198702 1 002		
MENGETAHUI / MENYETUJUI	TGL	TANDA TANGAN
PEJABAT PEMBUAT KOMITMEN UNIVERSITAS JEMBER		
BADERUN, SE NIP. 19630215 198703 1 002		
MENGETAHUI / MENYETUJUI	TGL	TANDA TANGAN
KEPALA BIRO III UNIVERSITAS JEMBER		
Drs. SUGIARTO, S.H., M.M. NIP. 19581220 198003 1 001		
MENGETAHUI / MENYETUJUI	TGL	TANDA TANGAN
DEKAN FAKULTAS EKONOMI UNIVERSITAS JEMBER		
DR. M. FATHORRAZI, M.Si NIP. 196306 14199002 1 001		
MENGETAHUI / MENYETUJUI	TGL	TANDA TANGAN
KETUA TIM TEKNIS		
Ir. HERNU SUYOSO, M.T. NIP. 19551112 198702 1 001		
KONSULTAN PERENCANA		
Architect - Planner - Construction - Consultant		
PT. DEWI PERMATA MANDIRI		
Kantor : Jl. Langsep Raya No. 02A / 08 Tlp. (0331) 424080 Jember 68111		
. Perencana - Perancang - Pengawas & Manajemen Konstruksi .		
DIGAMBAR	DIPERIKSA	PENANGGUNG JAWAB GAMBAR
SOLEHUDIN ZUHRI, ST DRAFTER	Ir. PONIMAN TENAGA AHLI STRUKTUR	Ir. SRIWIYONO DIREKTUR UTAMA
JUDUL GAMBAR		SKALA
PORTAL AS ANGKA		1 : 150
KODE GAMBAR	NOMOR LEMBAR	JUMLAH LEMBAR
STR	26	31

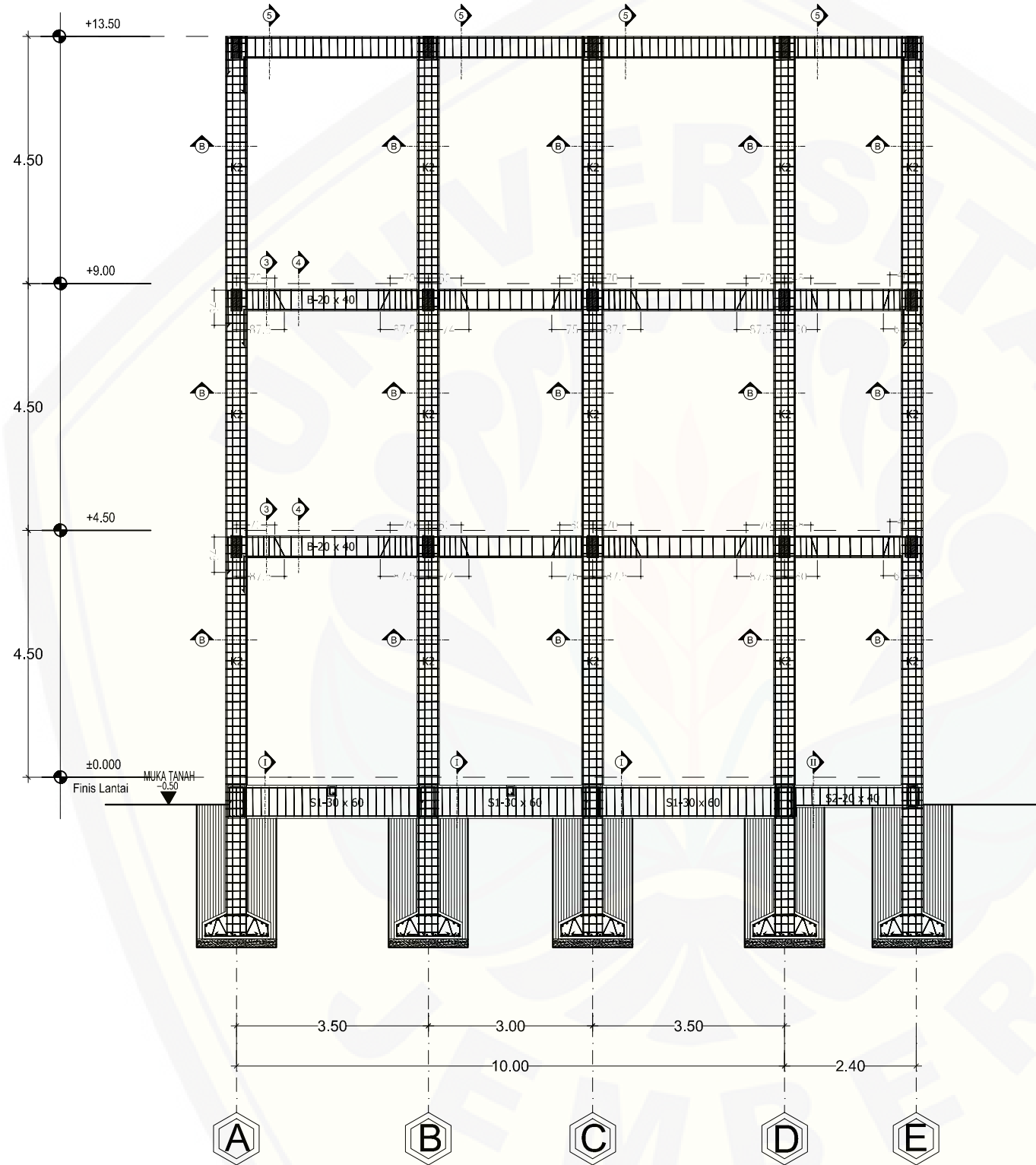

PORTAL AS - 9
SKALA 1 : 150



KEMENTERIAN RISET, TEKNOLOGI
DAN PENDIDIKAN TINGGI
UNIVERSITAS JEMBER
Jl. Kalimantan no. 37 Kampus Tegai Boto Kotak Pos 159
Telp. (0331) 32445, 324446 Fax (0331) - 339029, 337422
JEMBER

KEGIATAN

SARANA / PRASARANA
PENDUKUNG PEMBELAJARAN

PEKERJAAN

PEMBANGUNAN GEDUNG
AKUNTANSI FAKULTAS EKONOMI
(TAHAP 1)

LOKASI

UNIVERSITAS JEMBER

MENGETAHUI / MENYETUJUI	TGL	TANDA TANGAN
PEMBANTU REKTOR II UNIVERSITAS JEMBER DR. AKHMAD TOHA, M.Si. NIP. 19571227 198702 1 002		
MENGETAHUI / MENYETUJUI	TGL	TANDA TANGAN
PEJABAT PEMBUAT KOMITMEN UNIVERSITAS JEMBER BADERUN, SE NIP. 19630215 198703 1 002		
MENGETAHUI / MENYETUJUI	TGL	TANDA TANGAN
KEPALA BIRO III UNIVERSITAS JEMBER Drs. SUGIARTO, S.H., M.M. NIP. 19581220 198003 1 001		
MENGETAHUI / MENYETUJUI	TGL	TANDA TANGAN
DEKAN FAKULTAS EKONOMI UNIVERSITAS JEMBER DR. M. FATHORRAZI, M.Si NIP. 196306 14199002 1 001		
MENGETAHUI / MENYETUJUI	TGL	TANDA TANGAN
KETUA TIM TEKNIS Ir. HERNU SUYOSO, M.T. NIP. 19551112 198702 1 001		

KONSULTAN PERENCANA

Architect - Planner - Construction - Consultant
PT. DEWI PERMATA MANDIRI
Kantor : Jl. Langsep Raya No. 02A / 08 Tlp. (0331) 424080 Jember 68111
. Perencana - Perancang - Pengawas & Manajemen Konstruksi .

DIGAMBAR	DIPERIKSA	PENANGGUNG JAWAB GAMBAR
SOLEHUDIN ZUHRI, ST DRAFTER	Ir. PONIMAN TENAGA AHLI STRUKTUR	Ir. SRIWIYONO DIREKTUR UTAMA
JUDUL GAMBAR		SKALA
PORTAL AS ANGKA		1 : 150
KODE GAMBAR	NOMOR LEMBAR	JUMLAH LEMBAR
STR	27	31



KEGIATAN

SARANA / PRASARANA
 PENDUKUNG PEMBELAJARAN

PEKERJAAN

PEMBANGUNAN GEDUNG
 AKUNTANSI FAKULTAS EKONOMI
 (TAHAP 1)

LOKASI

UNIVERSITAS JEMBER

MENGETAHUI / MENYETUJUI TGL TANDA TANGAN

PEMBANTU REKTOR II
 UNIVERSITAS JEMBER

DR. AKHMAD TOHA, M.Si.
 NIP. 19571227 198702 1 002

MENGETAHUI / MENYETUJUI TGL TANDA TANGAN

PEJABAT PEMBUAT KOMITMEN
 UNIVERSITAS JEMBER

BADERUN, SE
 NIP. 19630215 198703 1 002

MENGETAHUI / MENYETUJUI TGL TANDA TANGAN

KEPALA BIRO III
 UNIVERSITAS JEMBER

Drs. SUGIARTO, S.H., M.M.
 NIP. 19591220 198003 1 001

MENGETAHUI / MENYETUJUI TGL TANDA TANGAN

DEKAN FAKULTAS EKONOMI
 UNIVERSITAS JEMBER

DR. M. FATHORRAZI, M.Si.
 NIP. 196306 14199002 1 001

MENGETAHUI / MENYETUJUI TGL TANDA TANGAN

KETUA TIM TEKNIS

Ir. HERNU SUYOSO, M.T.
 NIP. 19551112 198702 1 001

KONSULTAN PERENCANA

Architect - Planner - Construction - Consultant
PT. DEWI PERMATA MANDIRI
 Kantor : Jl. Langsep Raya No. 02A / 08 Tlp. (0331) 424080 Jember 68111
 . Perencana - Perancang - Pengawas & Manajemen Konstruksi .

DIGAMBAR DIPERIKSA PENANGGUNG JAWAB GAMBAR

SOLEHUDIN ZUHRI, ST DRAFTER	Ir. PONIMAN TENAGA AHLI STRUKTUR	Ir. SRIWIYONO DIREKTUR UTAMA
--------------------------------	-------------------------------------	---------------------------------

JUDUL GAMBAR SKALA

DETAIL TANGGA	1 : 50
---------------	--------

KODE GAMBAR NOMOR LEMBAR JUMLAH LEMBAR

STR	28	31
-----	----	----

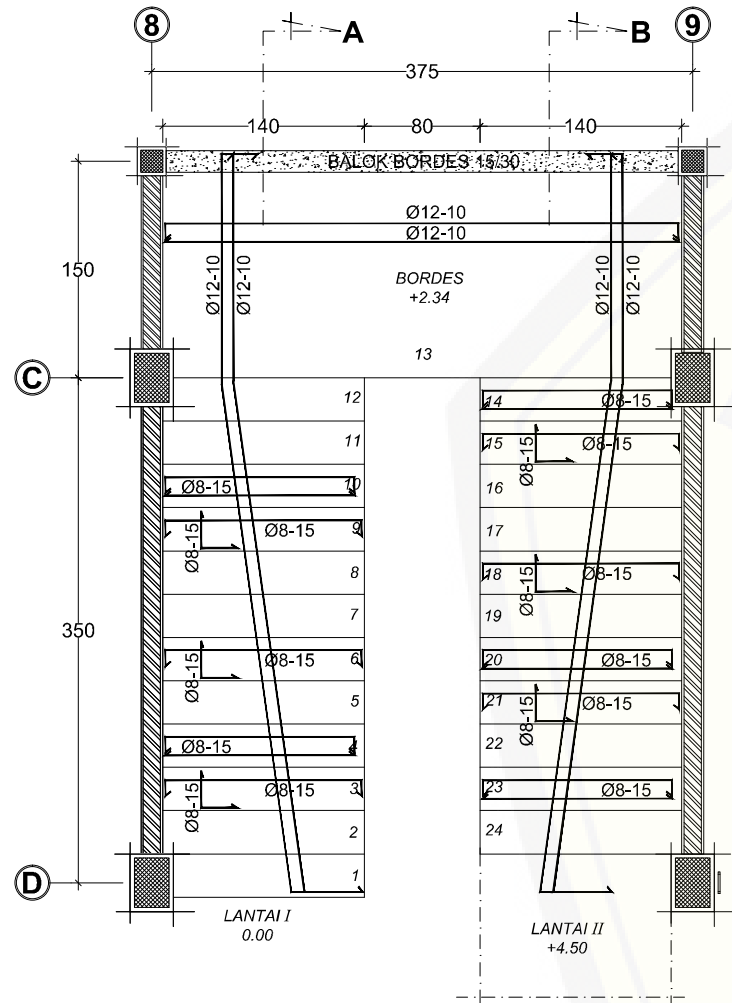

DETAIL TANGGA
 SKALA 1 : 50

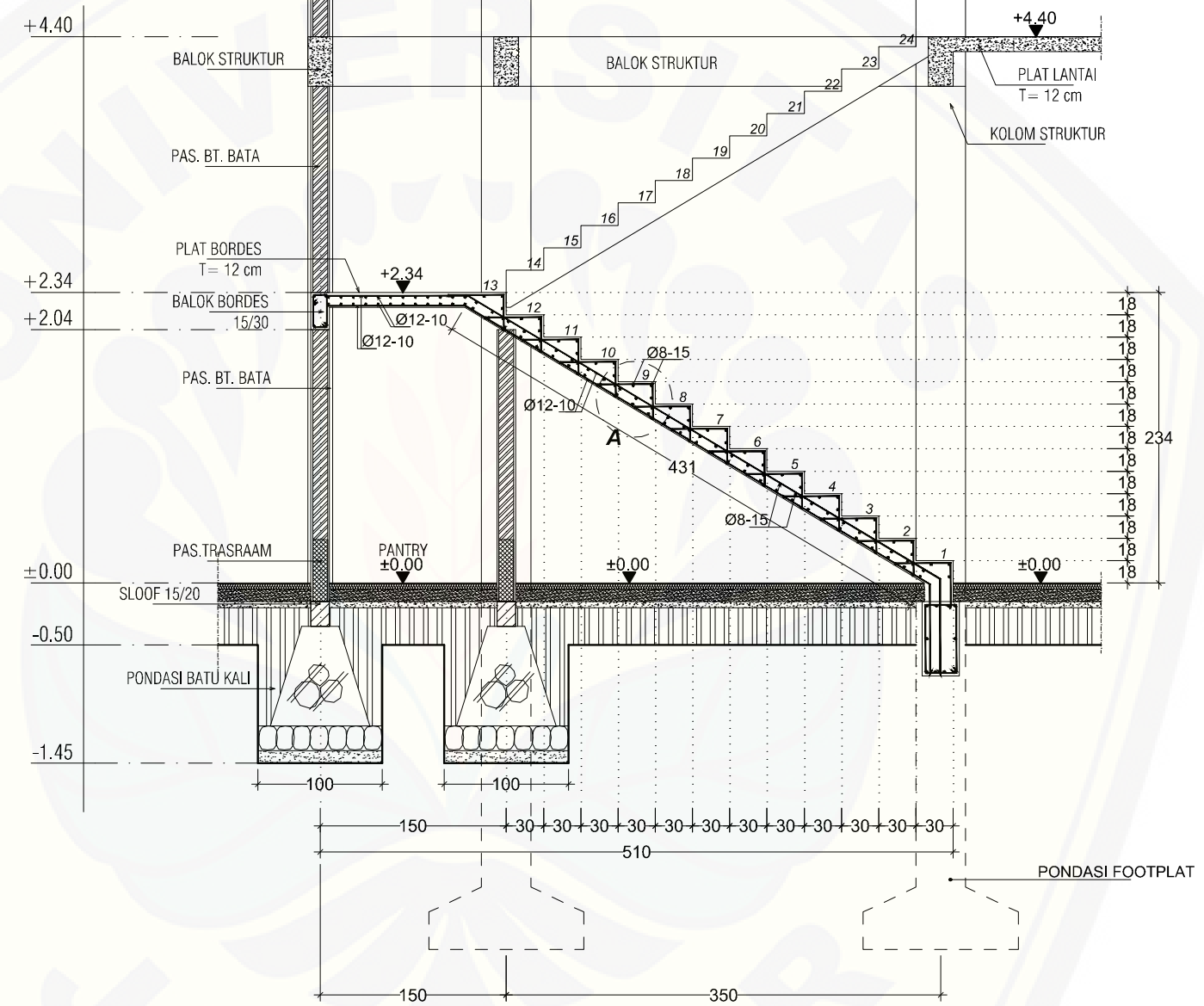

POTONGAN A-A
 SKALA 1 : 150



KEMENTERIAN RISET, TEKNOLOGI DAN PENDIDIKAN TINGGI
UNIVERSITAS JEMBER
 Jl. Kalimantan no. 37 Kampus Tegai Boto Kotak Pos 159
 Telp. (0331) 32445, 324446 Fax (0331) - 339029, 337422
JEMBER

KEGIATAN

SARANA / PRASARANA
 PENDUKUNG PEMBELAJARAN

PEKERJAAN

PEMBANGUNAN GEDUNG
 AKUNTANSI FAKULTAS EKONOMI
 (TAHAP 1)

LOKASI

UNIVERSITAS JEMBER

MENGETAHUI / MENYETUJUI	TGL	TANDA TANGAN
PEMBANTU REKTOR II UNIVERSITAS JEMBER		
DR. AKHMAD TOHA, M.Si. NIP. 19571227 198702 1 002		
MENGETAHUI / MENYETUJUI	TGL	TANDA TANGAN
PEJABAT PEMBUAT KOMITMEN UNIVERSITAS JEMBER		
BADERUN, SE NIP. 19630215 198703 1 002		
MENGETAHUI / MENYETUJUI	TGL	TANDA TANGAN
KEPALA BIRO III UNIVERSITAS JEMBER		
Drs. SUGIARTO, S.H., M.M. NIP. 19581220 198003 1 001		
MENGETAHUI / MENYETUJUI	TGL	TANDA TANGAN
DEKAN FAKULTAS EKONOMI UNIVERSITAS JEMBER		
DR. M. FATHORRAZI, M.Si. NIP. 196306 14199002 1 001		
MENGETAHUI / MENYETUJUI	TGL	TANDA TANGAN
KETUA TIM TEKNIS		
Ir. HERNU SUYOSO, M.T. NIP. 19551112 198702 1 001		

KONSULTAN PERENCANA

Architect - Planner - Construction - Consultant
PT. DEWI PERMATA MANDIRI
 Kantor : Jl. Langsep Raya No. 02A / 08 Tlp. (0331) 424080 Jember 68111
 . Perencana - Perancang - Pengawas & Manajemen Konstruksi .

DIGAMBAR	DIPERIKSA	PENANGGUNG JAWAB GAMBAR
SOLEHUDIN ZUHRI, ST DRAFTER	Ir. PONIMAN TENAGA AHLI STRUKTUR	Ir. SRIWIYONO DIREKTUR UTAMA
JUDUL GAMBAR		SKALA
DETAIL TANGGA		1 : 50
KODE GAMBAR	NOMOR LEMBAR	JUMLAH LEMBAR
STR	29	31

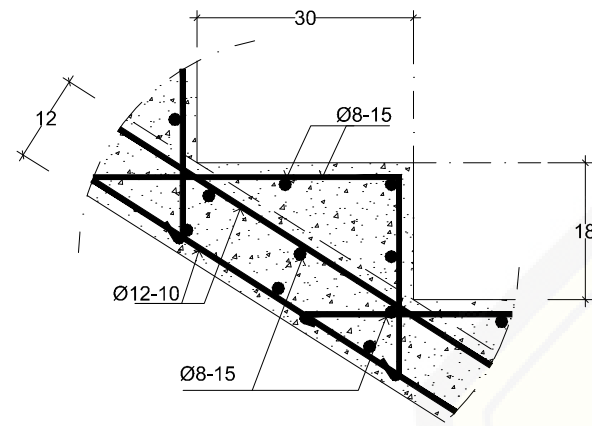

DETAIL A
 SKALA 1 : 10

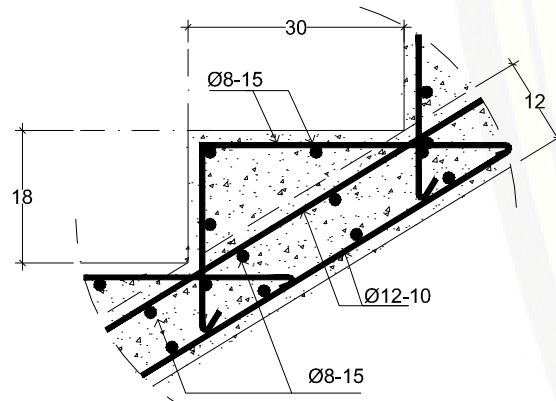

DETAIL B
 SKALA 1 : 10

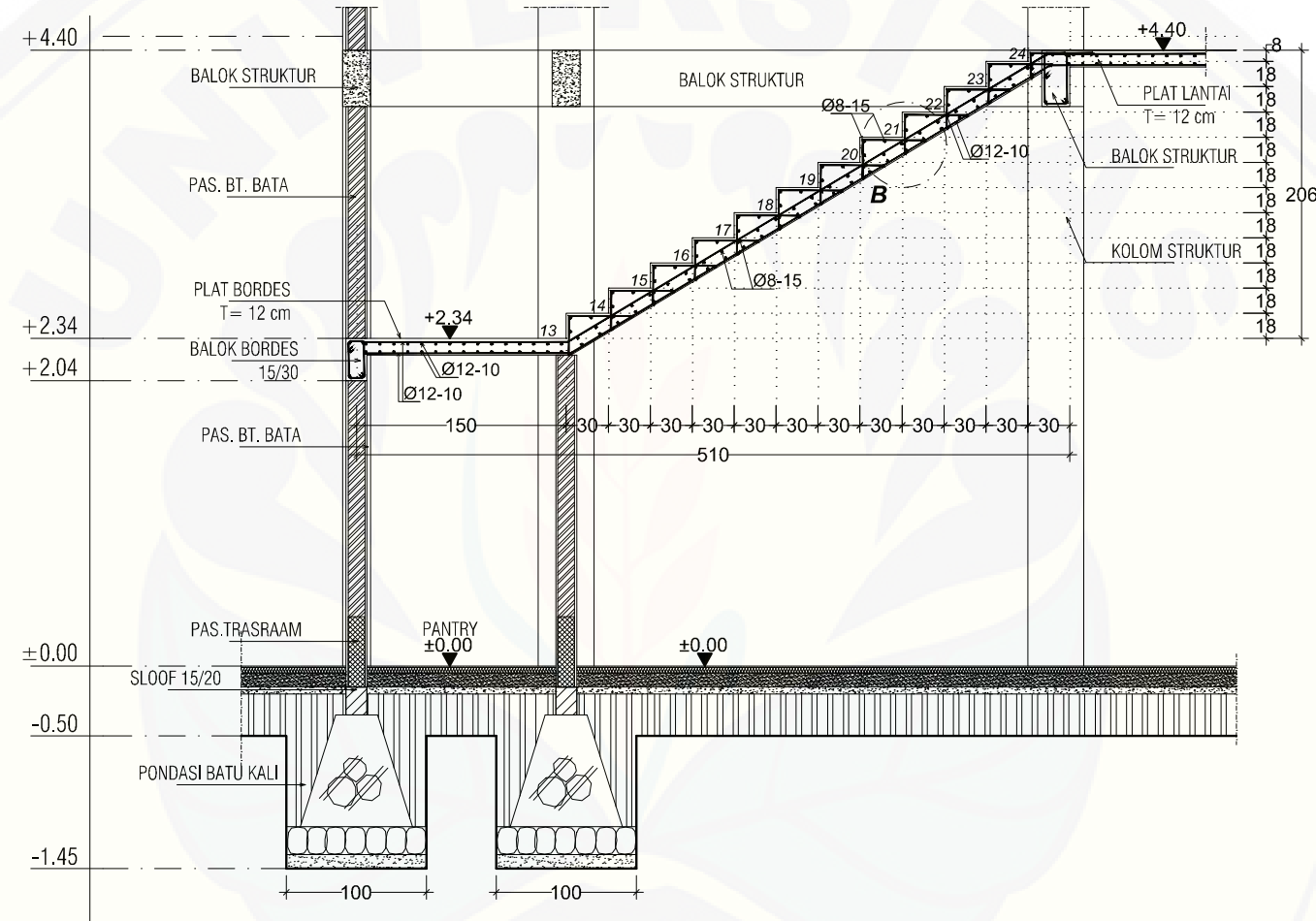

POTONGAN B-B
 SKALA 1 : 150



KEMENTERIAN RISET, TEKNOLOGI
DAN PENDIDIKAN TINGGI
UNIVERSITAS JEMBER
Jl. Kalimantan no. 37 Kampus Tegai Boto Kotak Pos 159
Telp. (0331) 32445, 324446 Fax (0331) - 339029, 337422
JEMBER

KEGIATAN

SARANA / PRASARANA
PENDUKUNG PEMBELAJARAN

PEKERJAAN

PEMBANGUNAN GEDUNG
AKUNTANSI FAKULTAS EKONOMI
(TAHAP 1)

LOKASI

UNIVERSITAS JEMBER

MENGETAHUI / MENYETUJUI	TGL	TANDA TANGAN
PEMBANTU REKTOR II UNIVERSITAS JEMBER		
DR. AKHMAD TOHA, M.Si. NIP. 19571227 198702 1 002		
MENGETAHUI / MENYETUJUI	TGL	TANDA TANGAN
PEJABAT PEMBUAT KOMITMEN UNIVERSITAS JEMBER		
BADERUN, SE NIP. 19630215 198703 1 002		
MENGETAHUI / MENYETUJUI	TGL	TANDA TANGAN
KEPALA BIRO III UNIVERSITAS JEMBER		
Drs. SUGIARTO, S.H., M.M. NIP. 19581220 198003 1 001		
MENGETAHUI / MENYETUJUI	TGL	TANDA TANGAN
DEKAN FAKULTAS EKONOMI UNIVERSITAS JEMBER		
DR. M. FATHORRAZI, M.Si. NIP. 196306 14199002 1 001		
MENGETAHUI / MENYETUJUI	TGL	TANDA TANGAN
KETUA TIM TEKNIS		
Ir. HERNU SUYOSO, M.T. NIP. 19551112 198702 1 001		

KONSULTAN PERENCANA

Architect - Planner - Construction - Consultant
PT. DEWI PERMATA MANDIRI
Kantor : Jl. Langsep Raya No. 02A / 08 Tlp. (0331) 424080 Jember 68111
. Perencana - Perancang - Pengawas & Manajemen Konstruksi .

DIGAMBAR	DIPERIKSA	PENANGGUNG JAWAB GAMBAR
SOLEHUDIN ZUHRI, ST DRAFTER	Ir. PONIMAN TENAGA AHLI STRUKTUR	Ir. SRIWIYONO DIREKTUR UTAMA
JUDUL GAMBAR		SKALA
DETAIL TANGGA		1 : 50
KODE GAMBAR	NOMOR LEMBAR	JUMLAH LEMBAR
STR	31	31

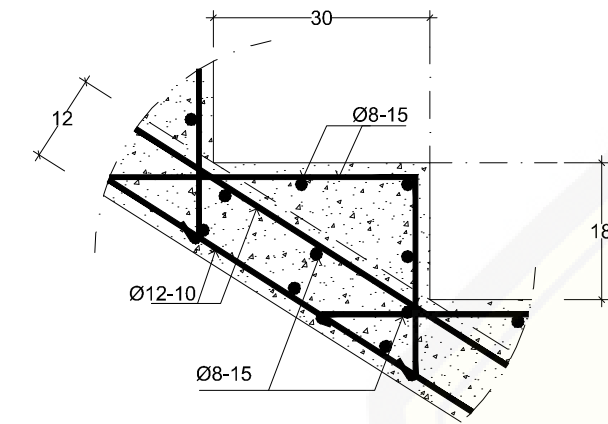

DETAIL A
SKALA 1 : 10

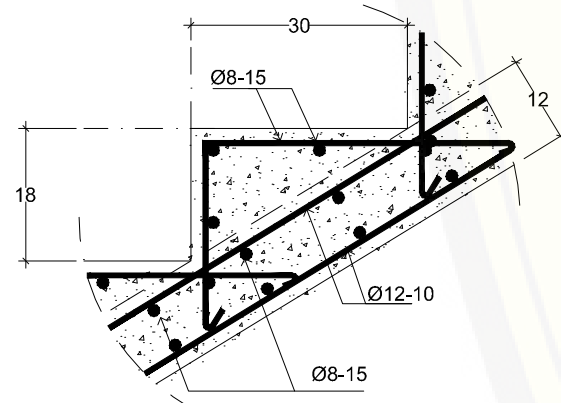

DETAIL B
SKALA 1 : 10

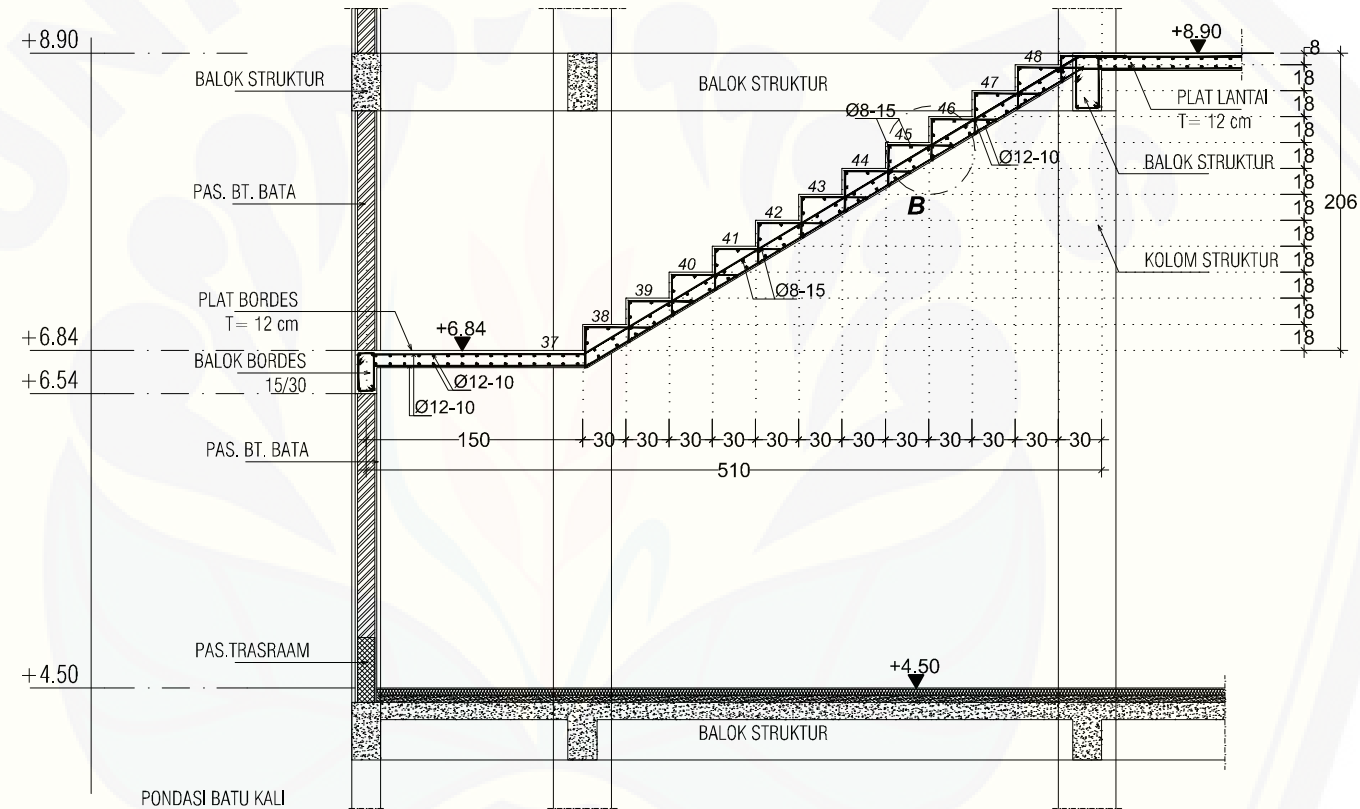

POTONGAN D-D
SKALA 1 : 150

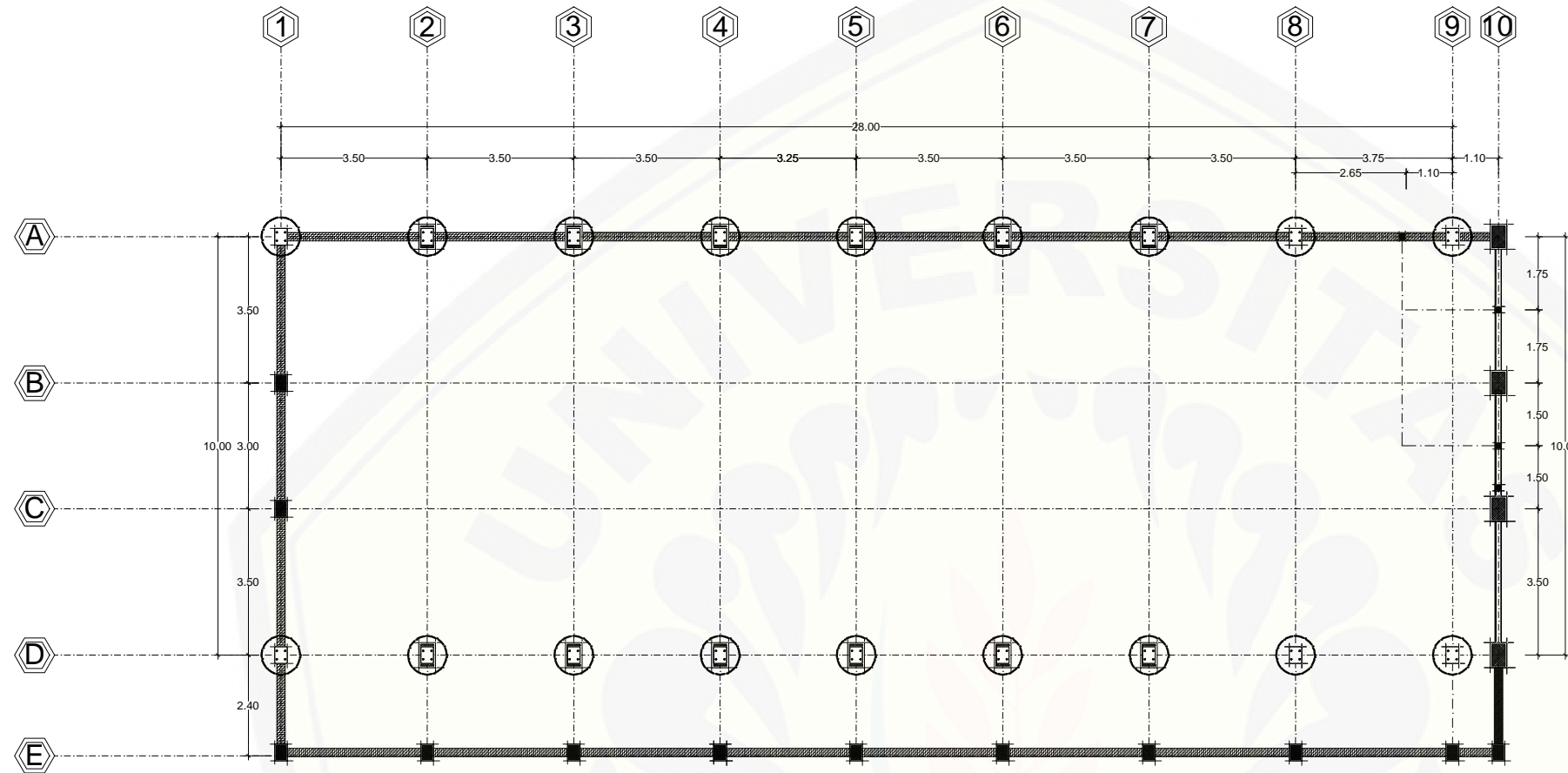

RENCANA PELETAKAN ANGKER KUDA - KUDA ATAP
SKALA 1 : 150

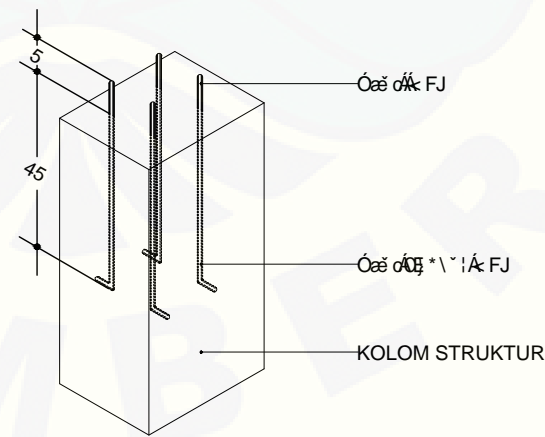
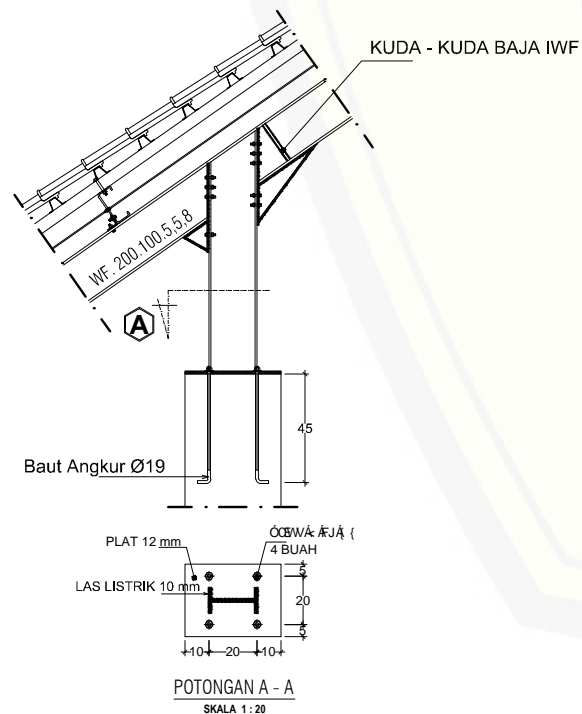

ISOMETRI PEMASANGAN ANGKER
SKALA NTSC



KEMENTERIAN RISET, TEKNOLOGI
DAN PENDIDIKAN TINGGI
UNIVERSITAS JEMBER
Jl. Kalimantan no. 37 Kampus Tegol Boto Kotak Pos 159
Telp. (0331) 32445, 324446 Fax (0331) - 339029, 337422
JEMBER

KEGIATAN

SARANA / PRASARANA
PENDUKUNG PEMBELAJARAN

PEKERJAAN

PEMBANGUNAN GEDUNG
AKUNTANSI FAKULTAS EKONOMI
(TAHAP 1)

LOKASI

UNIVERSITAS JEMBER

MENGETAHUI / MENYETUJUI	TGL	TANDA TANGAN
PEMBANTU REKTOR II UNIVERSITAS JEMBER DR. AKHMAD TOHA, M.Si. NIP. 19571227 198702 1 002		
PEJABAT PEMBUAT KOMITMEN UNIVERSITAS JEMBER BADERUN, SE NIP. 19630215 198703 1 002		
KEPALA BIRO III UNIVERSITAS JEMBER Drs. SUGIARTO, S.H., M.M. NIP. 19591220 198003 1 001		
DEKAN FAKULTAS EKONOMI UNIVERSITAS JEMBER DR. M. FATHORRAZI, M.Si. NIP. 196306 14199002 1 001		
KETUA TIM TEKNIS Ir. HERNU SUYOSO, M.T. NIP. 19551112 198702 1 001		

KONSULTAN PERENCANA

Architect - Planner - Construction - Consultant
PT. DEWI PERMATA MANDIRI
Kantor : Jl. Langsep Raya No. 02A / 08 Tlp. (0331) 424080 Jember 68111
. Perencana - Perancang - Pengawas & Manajemen Konstruksi .

DIGAMBAR	DIPERIKSA	PENANGGUNG JAWAB GAMBAR
SOLEHUDIN ZUHRI, ST. DRAFTER	Ir. PONIMAN TENAGA AHLI STRUKTUR	Ir. SRIWIYONO DIREKTUR UTAMA
JUDUL GAMBAR		SKALA
RENCANAPELETAKAN ANGKER KUDA - KUDA ATAP DETAIL ANGKER		1 : 150 1 : 20
KODE GAMBAR	NOMOR LEMBAR	JUMLAH LEMBAR
STR	27A	27

2. Volume Pekerjaan



HITUNGAN VOLUME

PEKERJAAN
LOKASI
TH. ANGGARAN

NO.	GAMBAR	PERHITUNGAN	VOLUME
		<u>Membersihkan Lapangan dan Pemerataan</u>	
		$= 15.00 \times 30.00$	$= 450.00 \text{ m}^2$
			450.00 m²
		<u>PAS. BOWPLANK</u>	
		$= 15.40 + 32.10 \times 2.00$	$= 79.60 \text{ m}'$
			79.60 m'
		<u>PEKERJAAN TANAH</u>	
		<u>GALIAN PONDASI POER TYPE P 1</u>	
		$= 2.00 \times 2.00 \times 2.35 \times 7.00 \times 2.00$	$= 131.60 \text{ m}^3$
			131.60 m³
		<u>GALIAN PONDASI POER TYPE P 2</u>	
		$= 1.25 \times 1.25 \times 2.35 \times 4.00 \times 3.00$	$= 44.06 \text{ m}^3$
		$= 1.25 \times 1.25 \times 2.35 \times 9.00$	$= 33.05 \text{ m}^3$
			$= 77.11 \text{ m}^3$
			77.11 m³
		<u>GALIAN TANAH PONDASI MENERUS</u>	
		$= 1.00 \times 1.10 \times 2.00 \times 7.00 \times 2.00$	$= 30.80 \text{ m}^3$
		$= 1.00 \times 1.10 \times 2.00 \times 2.00 \times 3.00$	$= 13.20 \text{ m}^3$
		$= 1.00 \times 1.10 \times 1.50 \times 1.00 \times 3.00$	$= 4.95 \text{ m}^3$
		$= 1.00 \times 1.10 \times 1.05 \times 4.00 \times 1.00$	$= 4.62 \text{ m}^3$

= 1.00 X 1.10 X 2.25 X 7.00 X 2.00	= 34.65 m3	
= 1.00 X 1.10 X 2.38 X 1.00 X 1.00	= 2.61 m3	
= 1.00 X 1.10 X 1.20 X 4.00 X 1.00	= 5.28 m3	
	= 96.11 m3	96.11 m3
<u>URUGAN TANAH KEMBALI</u>		
Pondasi poer = 92.12 + 30.84 + 23.13	= 146.10 m3	
Pondasi menerus = 96.11 X 0.30	= 28.83 m3	
	= 174.93 m3	174.93 m3
<u>URUGAN TANAH BW. LANTAI</u>		
= 0.20 X 9.85 X 24.35 X 1.00	= 47.97 m3	
= 0.20 X 9.85 X 4.10 X 1.00	= 8.08 m3	
= 0.20 X 2.25 X 28.10 X 1.00	= 12.65 m3	
	= 68.69 m3	68.69 m3
<u>URUGAN PASIR BW. LANTAI</u>		
= 0.10 X 9.85 X 24.35 X 1.00	= 23.98 m3	
= 0.10 X 9.85 X 4.10 X 1.00	= 4.04 m3	
= 0.10 X 2.25 X 28.10 X 1.00	= 6.32 m3	
	= 34.35 m3	34.35 m3
<u>URUGAN PASIR BW. PONDASI</u>		
Pondasi Poer = 0.10 X 1.50 X 1.50 X 14.00	= 3.15 m3	
= 0.10 X 1.25 X 1.25 X 22.00	= 3.44 m3	
Pondasi Menerus = 0.10 X 1.00 X 29.10 X 3.00	= 8.73 m3	
= 0.10 X 1.00 X 12.40 X 6.00	= 7.44 m3	
= 0.10 X 1.00 X 10.00 X 1.00	= 1.00 m3	
= 0.10 X 1.00 X 4.85 X 2.00	= 0.97 m3	
	= 24.73 m3	24.73 m3

<u>PEKERJAAN PONDASI BT. KALI</u>														
<u>AANSTAMPING</u>														
	=	0.20	X	1.00	X	29.10	X	3.00	=	17.46	m ³			
	=	0.20	X	1.00	X	12.40	X	6.00	=	14.88	m ³			
	=	0.20	X	1.00	X	10.00	X	1.00	=	2.00	m ³			
	=	0.20	X	1.00	X	4.85	X	2.00	=	1.94	m ³			
									=	36.28	m³	36.28 m³		
<u>PONDASI BT. KALI</u>														
	=	$\frac{0.30 + 0.70}{2}$	X	0.70	X	29.10	X	3.00	=	30.56	m ³			
	=	$\frac{0.30 + 0.70}{2}$	X	0.70	X	12.40	X	6.00	=	26.04	m ³			
	=	$\frac{0.30 + 0.70}{2}$	X	0.70	X	10.00	X	1.00	=	3.50	m ³			
	=	$\frac{0.30 + 0.70}{2}$	X	0.70	X	4.85	X	2.00	=	3.40	m ³			
									=	63.49	m³	63.49 m³		
<u>PEKERJAAN BETON</u>														
<u>LANTAI 1</u>														
<u>LANTAI KERJA</u>														
TYPE P1	=	0.05	X	2.00	X	2.00	X	7.00	X	2.00	=	2.80	m ³	
TYPE P2	=	0.05	X	1.25	X	1.25	X	5.00	X	3.00	=	1.17	m ³	
	=	0.05	X	1.25	X	1.25	X	7.00	X	1.00	=	0.55	m ³	
											=	4.52	m³	4.52 m³
<u>RABAT BETON 5 CM BAWAH LANTAI</u>														
	=	0.05	X	9.85	X	24.35	X	1.00	=	11.99	m ³			
	=	0.05	X	9.85	X	4.10	X	1.00	=	2.02	m ³			

$= 0.05 \times 2.25 \times 28.10 \times 1.00$	$= 3.16 \text{ m}^3$	
	$= 17.17 \text{ m}^3$	17.17 m³
<u>PONDASI POER</u>		
P 1	$= 0.30 \times 2.00 \times 2.00 \times 6.00 \times 2.00$	$= 14.40 \text{ m}^3$
	$= \left(\frac{0.40 \times 0.60 + 2.00 \times 2.00}{2} \right) \times 0.10 \times 6.00$	$= 2.54 \text{ m}^3$
P 2	$= 0.30 \times 1.25 \times 1.25 \times 21.00 \times 1.00$	$= 9.84 \text{ m}^3$
	$= \left(\frac{0.40 \times 0.60 + 1.25 \times 1.25}{2} \right) \times 0.10 \times 21.00$	$= 1.89 \text{ m}^3$
	$= 28.68 \text{ m}^3$	28.68 m³
<u>BETON PONDASI PLAT SETEMPAT TANGGA</u>		
	$= 0.30 \times 1.00 \times 1.35$	$= 0.41 \text{ m}^3$
		0.41 m³
<u>BETON KOLOM PONDASI TANGGA</u>		
	$= 0.15 \times 1.35 \times 1.20$	$= 0.24 \text{ m}^3$
		0.24 m³
<u>BETON SLOOF 20/40</u>		
	$= 0.20 \times 0.40 \times 1.90 \times 6.00$	$= 0.91 \text{ m}^3$
	$= 0.20 \times 0.40 \times 3.10 \times 8.00 \times 3.00$	$= 5.95 \text{ m}^3$
	$= 0.20 \times 0.40 \times 3.85 \times 2.00 \times 3.00$	$= 1.85 \text{ m}^3$
	$= 8.71 \text{ m}^3$	8.71 m³
<u>BETON SLOOF 30/60</u>		
	$= 0.30 \times 0.60 \times 9.40 \times 3.00$	$= 5.08 \text{ m}^3$
	$= 0.30 \times 0.60 \times 3.00 \times 3.00$	$= 1.62 \text{ m}^3$
	$= 0.30 \times 0.60 \times 2.60 \times 3.00$	$= 1.40 \text{ m}^3$
	$= 8.10 \text{ m}^3$	8.10 m³

<u>KOLOM BETON 40/60</u>														
=	0.40	x	0.60	x	6.35	x	6.00	x	2.00	=	18.29	m ³	18.29	m ³
<u>KOLOM 30/40</u>														
=	0.30	x	0.40	x	6.35	x	21.00	x	1.00	=	16.00	m ³	16.00	m ³
<u>KOLOM PRAKTIS 12/12</u>														
=	4.55	X	7.00			=	31.85	m'						
=	2.09	X	3.00			=	6.27	m'						
						=	38.12	m'			38.12	m'		
<u>BALOK LATEI 11/20</u>														
=	0.11	X	0.20	X	3.10	X	8.00	X	2.00	=	1.09	m ³		
=	0.11	X	0.20	X	3.00	X	2.00	X	2.00	=	0.26	m ³		
=	0.11	X	0.20	X	2.60	X	1.00	X	2.00	=	0.11	m ³		
						=	1.47	m ³			1.47	m ³		
<u>BALOK GANTUNG SELASAR 12/30</u>														
=	0.12	X	0.30	X	2.00	X	1.00	X	2.00	=	0.14	m ³		
=	0.12	X	0.30	X	3.20	X	8.00	X	1.00	=	0.92	m ³	0.92	m ³
<u>PLAT LUEVEL SELASAR tbl. 12</u>														
=	0.07	X	0.15	X	3.20	X	1.00	X	9.00	=	0.30	m ³		
=	0.07	X	0.15	X	2.80	X	1.00	X	1.00	=	0.03	m ³		
						=	0.33	m ³			0.33	m ³		
<u>BALOK BORDES 20/30</u>														
=	0.20	X	0.30	X	3.35					=	0.20	m ³	0.20	m ³

<u>PLAT DAN TRAP TANGGA</u>													
	=	0.12	X	1.20	X	4.20		=	0.60 m ³				
	=	0.12	X	1.20	X	3.35		=	0.48 m ³				
	=	0.12	X	1.20	X	3.95		=	0.57 m ³				
Trap	=	0.50	X	0.18	X	0.30	X	1.20	X	12.00	=	0.39 m ³	
	=	0.50	X	0.18	X	0.30	X	1.20	X	12.00	=	0.39 m ³	
											=	2.43 m³	2.43 m³
<u>PLAT BORDES</u>													
	=	0.12	X	1.50	X	2.45		=	0.44 m ³	0.44 m³			
<u>KONSOL BETON 12/15</u>													
Depan + belakang	=	0.12	X	0.15	X	1.70	X	10.00	X	2.00	=	0.61 m ³	
	=	0.12	X	0.15	X	0.82	X	10.00	X	2.00	=	0.29 m ³	
Samping kanan + kiri	=	0.12	X	0.15	X	1.70	X	5.00	X	1.00	=	0.15 m ³	
	=	0.12	X	0.15	X	0.82	X	5.00	X	1.00	=	0.07 m ³	
											=	1.13 m³	1.13 m³
<u>BETON LANTAI 2</u>													
<u>BALOK LATEI 11/20</u>													
	=	0.11	X	0.20	X	3.35	X	2.00	X	5.00	=	0.74 m ³	
	=	0.11	X	0.20	X	2.85	X	1.00	X	5.00	=	0.31 m ³	
	=	0.11	X	0.20	X	2.90	X	2.00	X	9.00	=	1.15 m ³	
											=	2.20 m³	2.20 m³
<u>BALOK GANTUNG 12/30 TERAS</u>													
	=	0.12	X	0.30	X	1.95	X	1.00	X	2.00	=	0.14 m ³	
	=	0.12	X	0.30	X	3.20	X	1.00	X	9.00	=	1.04 m ³	1.04 m³

PLAT LUEVEL tbl. 7 CM TERAS			
=	0.07 X 0.15 X 3.20 X 1.00 X 9.00	=	0.30 m ³
=	0.07 X 0.15 X 2.80 X 1.00 X 1.00	=	0.03 m ³
		=	0.33 m³
KOLOM PRAKTIS 12/12			
=	4.55 X 9.00	=	40.95 m'
			40.95 m'
KOLOM TERAS 30/40			
=	0.30 X 0.40 X 4.10 X 6.00	=	2.95 m ³
			2.95 m³
KOLOM BETON 40/60			
=	0.40 X 0.60 X 3.90 X 9.00 X 2.00	=	16.85 m ³
			16.85 m³
BALOK INDUK 35/75			
=	0.35 X 0.75 X 9.40 X 1.00 X 6.00	=	14.81 m ³
=	0.35 X 0.75 X 3.00 X 1.00 X 6.00	=	4.73 m ³
=	0.35 X 0.75 X 2.60 X 1.00 X 3.00	=	2.05 m ³
		=	21.58 m³
BALOK ANAK 20/40			
=	0.20 X 0.40 X 3.10 X 5.00 X 8.00	=	9.92 m ³
			9.92 m³
BALOK ANAK 11/20			

$= 0.11 \times 0.20 \times 2.80$	$= 0.06 \text{ m}^3$	
$= 0.11 \times 0.20 \times 1.05 + 0.11 \times 0.20 \times 0.95$	$= 0.04 \text{ m}^3$	
$= 0.11 \times 0.20 \times 3.30$	$= 0.07 \text{ m}^3$	
$= 0.11 \times 0.20 \times 1.05 + 0.11 \times 0.20 \times 0.95$	$= 0.04 \text{ m}^3$	
	$= 0.22 \text{ m}^3$	0.22 m³
BALOK LATEI 11/20		
$= 0.11 \times 0.20 \times 3.20 \times 7.00 \times 2.00$	$= 0.99 \text{ m}^3$	
$= 0.11 \times 0.20 \times 3.00 \times 2.00 \times 2.00$	$= 0.26 \text{ m}^3$	
$= 0.11 \times 0.20 \times 2.50 \times 1.00 \times 2.00$	$= 0.11 \text{ m}^3$	
	$= 1.36 \text{ m}^3$	1.36 m³
PLAT DAN TRAP TANGGA		
$= 0.12 \times 1.20 \times 4.20$	$= 0.60 \text{ m}^3$	
$= 0.12 \times 1.20 \times 3.35$	$= 0.48 \text{ m}^3$	
$= 0.12 \times 1.20 \times 3.95$	$= 0.57 \text{ m}^3$	
Trap	$= 0.50 \times 0.18 \times 0.30 \times 1.20 \times 12.00$	$= 0.39 \text{ m}^3$
	$= 0.50 \times 0.18 \times 0.30 \times 1.20 \times 12.00$	$= 0.39 \text{ m}^3$
	$= 2.43 \text{ m}^3$	
BALOK GANTUNG SELASAR 12/30		
$= 0.12 \times 0.30 \times 1.90 \times 2.00 \times 1.00$	$= 0.14 \text{ m}^3$	
$= 0.12 \times 0.30 \times 3.20 \times 8.00 \times 1.00$	$= 0.92 \text{ m}^3$	
	$= 1.06 \text{ m}^3$	1.06 m³
RING BALK PAGAR		
$= (1.95 \times 2.00 + 3.20 \times 8.00) \times 0.11 \times 0.15$	$= 0.49 \text{ m}^3$	0.49 m³
PLAT LANTAI 2 TEBAL 12 CM		

	= 0.12 X 2.90 X 3.10 X 8.00 X 2.00	= 17.26 m ³	
	= 0.12 X 2.70 X 2.60 X 9.00	= 7.58 m ³	
	= 0.12 X 2.10 X 3.20 X 8.00	= 6.45 m ³	
DIKURANGI VIOD TANGGA	= -0.12 X 3.00 X 3.30 X 1.00	= -1.19 m ³	
		= 30.11 m ³	30.11 m³
<u>BETON LANTAI 3</u>			
<u>BALOK LATEI 15/20</u>			
	= 0.11 X 0.20 X 3.35 X 2.00 X 5.00	= 0.74 m ³	
	= 0.11 X 0.20 X 2.85 X 1.00 X 5.00	= 0.31 m ³	
	= 0.11 X 0.20 X 2.90 X 2.00 X 9.00	= 1.15 m ³	
		= 2.20 m ³	2.20 m³
<u>KOLOM PRAKTIS 12/12</u>			
	= 4.55 X 9.00	= 40.95 m'	40.95 m'
<u>KOLOM BETON 30/40</u>			
	= 0.30 X 0.40 X 4.10 X 9.00	= 4.43 m ³	4.43 m³
<u>KOLOM BETON 40/60</u>			
	= 0.40 X 0.60 X 4.10 X 9.00 X 2.00	= 17.71 m ³	17.71 m³
<u>BALOK INDUK 35/75</u>			
	= 0.35 X 0.75 X 9.40 X 6.00 X 1.00	= 14.81 m ³	
		= 14.81 m ³	14.81 m³

BALOK ANAK 20/40															
	=	0.20	X	0.40	X	3.10	X	5.00	X	7.00	=	8.68	m3		
	=	0.20	X	0.40	X	2.30	X	5.00	X	1.00	=	0.92	m3		
	=	0.20	X	0.40	X	3.10	X	5.00	X	9.00	=	11.16	m3		
											=	20.76	m3	20.76 m3	
BALOK ANAK 11/20															
	=	0.11	x	0.20	x	2.80					=	0.06	m3		
	=	0.11	x	0.20	x	1.05	+	0.11	x	0.20	x	0.95	=	0.04 m3	
	=	0.11	x	0.20	x	3.30					=	0.07	m3		
	=	0.11	x	0.20	x	1.05	+	0.11	x	0.20	x	0.95	=	0.04 m3	
											=	0.22	m3	0.22 m3	
BALOK LATEI 11/20															
	=	0.11	X	0.20	X	3.20	X	7.00	X	2.00	=	0.99	m3		
	=	0.11	X	0.20	X	3.00	X	2.00	X	2.00	=	0.26	m3		
	=	0.11	X	0.20	X	2.50	X	1.00	X	2.00	=	0.11	m3		
											=	1.36	m3	1.36 m3	
PLAT LANTAI 2 TEBAL 12 CM															
	=	0.12	X	2.90	X	3.10	X	8.00	X	2.00	=	17.26	m3		
	=	0.12	X	2.70	X	2.60	X	9.00			=	7.58	m3		
	=	0.12	X	2.10	X	3.20	X	8.00			=	6.45	m3		
DIKURANGI VIOD TANGGA	=	-0.12	X	3.00	X	3.30	X	1.00			=	-1.19	m3		
											=	30.11	m3	30.11 m3	
BALOK GANTUNG TERAS 12/30															

$= 0.12 \times 0.30 \times 1.95 \times 2.00$	$= 0.14 \text{ m}^3$	
$= 0.12 \times 0.30 \times 3.20 \times 8.00$	$= 0.92 \text{ m}^3$	
	$= 1.06 \text{ m}^3$	1.06 m³
RING BALK 20/40		
$= 0.20 \times 0.40 \times 3.10 \times 8.00 \times 2.00$	$= 3.97 \text{ m}^3$	
$= 0.20 \times 0.40 \times 3.00 \times 2.00 \times 2.00$	$= 0.96 \text{ m}^3$	
$= 0.20 \times 0.40 \times 2.60 \times 1.00 \times 2.00$	$= 0.42 \text{ m}^3$	
	$= 5.34 \text{ m}^3$	5.34 m³
RING BALK 11/20		
$= 0.10 \times 0.20 \times 3.00 \times 5.00$	$= 0.30 \text{ m}^3$	
$= 0.10 \times 0.20 \times 2.60 \times 3.00$	$= 0.16 \text{ m}^3$	
$= 0.10 \times 0.20 \times 1.00 \times 2.00$	$= 0.04 \text{ m}^3$	
$= 0.10 \times 0.20 \times 0.83 \times 2.00$	$= 0.03 \text{ m}^3$	
	$= 0.53 \text{ m}^3$	0.53 m³
RING BALK 11/15 = (1.95 X 2.00 + 3.20 X 8.00) x 0.11 x 0.15 = 0.49 m³		
PLAT DUDUKAN TANDON Tbl. 10 cm		
$= 0.10 \times 1.30 \times 2.80 + 0.10 \times 1.05 \times 1.44$	$= 0.66 \text{ m}^3$	
$= 0.10 \times 1.05 \times 1.44 \times 2.00$	$= 0.30 \text{ m}^3$	
	$= 0.96 \text{ m}^3$	0.96 m³
<u>PEKERJAAN PASANGAN</u>		
LANTAI 1		

BATA MERAH 1 : 3																	
KM / WC	=	1.90	X	1.60	X	2.00	+	1.90	X	1.85	X	1.00	=	9.60	m2		
	= (1.90	X	1.35	X	2.00	+	1.90	X	1.85	X	1.00	=	25.94	m2		
	=	0.70	X	3.10	X	7.00	X	1.00					=	15.19	m2		
	=	0.70	X	3.10	X	7.00	X	1.00					=	15.19	m2		
	=	0.70	X	3.00	X	2.00	X	2.00					=	8.40	m2		
	=	0.70	X	2.60	X	1.00	X	2.00					=	3.64	m2		
Bawah bordes	=	0.70	X	2.70	X	1.00	X	1.00					=	1.89	m2		
Pengurangan																	
Kusen pintu	=	-1.50	X	0.70	X	4.00	X	1.00					=	-4.20	m2		
	=	-0.30	X	1.72	X	1.00	X	1.00					=	-0.52	m2		
													=	75.12	m2	75.12	m2
LANTAI 2																	
BATA MERAH 1 : 3																	
KM / WC	=	1.50	X	1.35	X	2.00	+	1.50	X	1.85	X	1.00	=	6.83	m2		
	= (1.50	X	1.35	X	2.00	+	1.50	X	1.85	X	1.00	=	13.65	m2		
	=	0.20	X	2.90	X	8.00	X	2.00					=	9.28	m2		
	=	0.20	X	2.90	X	7.00	X	1.00					=	4.06	m2		
Pagar	=	0.20	X	3.05	X	2.00	X	2.00					=	2.44	m2		
	=	0.20	X	1.95	X	1.00	X	2.00					=	0.78	m2		
Diatas balok gantung	=	0.30	X	1.95	X	1.00	X	2.00					=	1.17	m2		
	=	0.30	X	3.10	X	8.00	X	1.00					=	7.44	m2		
Pengurangan																	
Kusen pintu	=	-1.50	X	0.70	X	3.00	X	1.00					=	-3.15	m2		
	=	-0.40	X	0.92	X	2.00	X	1.00					=	-0.74	m2		
	=	-0.40	X	1.72	X	2.00	X	1.00					=	-1.38	m2		
													=	40.38	m2	40.38	m2
LANTAI 3																	
BATA MERAH 1 : 3																	

KM / WC	=	1.50	X	1.35	X	2.00	+	1.50	X	1.85	X	1.00	=	6.83	m2	
	= (1.50	X	1.35	X	2.00	+	1.50	X	1.85	X	1.00	=	13.65	m2	
	=	0.20	X	2.90	X	8.00	X	2.00					=	9.28	m2	
	=	0.20	X	2.90	X	7.00	X	1.00					=	4.06	m2	
Pagar	=	0.20	X	3.05	X	2.00	X	2.00					=	2.44	m2	
	=	0.20	X	1.95	X	1.00	X	2.00					=	0.78	m2	
Diatas balok gantung	=	0.30	X	1.95	X	1.00	X	2.00					=	1.17	m2	
	=	0.30	X	3.10	X	8.00	X	1.00					=	7.44	m2	
Pengurangan																
Kusen pintu	=	-1.50	X	0.70	X	3.00	X	1.00					=	-3.15	m2	
	=	-0.40	X	0.92	X	2.00	X	1.00					=	-0.74	m2	
	=	-0.40	X	1.72	X	2.00	X	1.00					=	-1.38	m2	
													=	40.38	m2	40.38 m2
LANTAI 1																
BATA MERAH 1 : 6																
KM / WC	=	3.50	X	1.35	X	2.00	+	3.50	X	1.85	X	1.00	=	15.93	m2	
	= (3.50	X	1.35	X	2.00	+	3.50	X	1.85	X	1.00	=	63.70	m2	
	=	3.85	X	2.90	X	8.00	X	1.00					=	89.32	m2	
	=	3.85	X	2.90	X	7.00	X	1.00					=	78.16	m2	
	=	3.85	X	3.05	X	2.00	X	2.00					=	46.97	m2	
	=	3.85	X	2.55	X	1.00	X	2.00					=	19.64	m2	
Bawah bordes	=	0.50	X	3.07	X	1.84	+	1.47	X	1.84			=	5.53	m2	
Dinding Tangga	=	1.10	X	4.20	X	2.00	+	2.00	X	2.50	+	0.25	=	14.62	m2	
Diatas blk gantung	=	0.55	x	1.95	x	2.00	x	1.00					=	2.15	m2	
	=	0.55	x	3.20	x	8.00	x	1.00					=	14.08	m2	
Pengurangan																
Kusen pintu	=	-2.88	X	1.68	X	1.00	X	1.00					=	-4.84	m2	
	=	-2.88	X	0.88	X	1.00	X	1.00					=	-2.53	m2	
Pintu KM/WC	=	-0.70	X	2.00	X	4.00	X	1.00					=	-5.60	m2	
jendela	=	-2.36	X	1.32	X	7.00	X	2.00					=	-43.61	m2	

BV = -0.48 X 0.92 X 1.00 X 1.00	= -0.44 m2	
= -0.48 X 0.48 X 2.00 X 1.00	= -0.46 m2	
	= 292.59 m2	292.59 m2
LANTAI 2		
BATA MERAH 1 : 6		
KM / WC = 3.50 X 1.35 X 2.00 + 3.50 X 1.85 X 1.00	= 15.93 m2	
= (3.50 X 1.35 X 2.00 + 3.50 X 1.85 X 1.00	= 47.78 m2	
= 3.85 X 2.90 X 7.00 X 2.00	= 156.31 m2	
= 3.15 X 2.90 X 1.00 X 1.00	= 9.14 m2	
= 3.85 X 3.05 X 2.00 X 3.00	= 70.46 m2	
= 3.85 X 2.55 X 1.00 X 3.00	= 29.45 m2	
Dinding tangga = 1.10 X 4.20 X 2.00 + 2.00 X 2.50 + 0.25	= 14.62 m2	
Pagar teras = 0.80 X 1.95 X 1.00 X 2.00	= 3.12 m2	
= 0.80 X 3.20 X 1.00 X 8.00	= 20.48 m2	
Diatas blk gantung = 0.55 x 1.95 x 2.00 x 1.00	= 2.15 m2	
= 0.55 x 3.20 x 8.00 x 1.00	= 14.08 m2	
Pengurangan		
Kusen pintu = -2.38 X 2.78 X 2.00 X 2.00	= -26.47 m2	
= -2.38 X 0.88 X 2.00 X 3.00	= -12.57 m2	
= -2.00 X 0.70 X 2.00 X 3.00	= -8.40 m2	
jendela = -2.44 X 1.38 X 10.00 X 1.00	= -33.67 m2	
BV = -0.48 X 0.48 X 1.00 X 2.00	= -0.46 m2	
= -0.48 X 0.68 X 1.00 X 1.00	= -0.33 m2	
	= 301.60 m2	301.60 m2
LANTAI 3		
BATA MERAH 1 : 6		
KM / WC = 3.85 X 1.35 X 2.00 + 3.85 X 1.85 X 1.00	= 17.52 m2	
= (3.85 X 1.35 X 2.00 + 3.85 X 1.85 X 1.00	= 52.55 m2	
= 3.85 X 2.90 X 7.00 X 2.00	= 156.31 m2	

	= 2.65 X 2.90 X 1.00 X 1.00	= 7.69 m2	
	= 3.85 X 3.05 X 2.00 X 3.00	= 70.46 m2	
	= 3.85 X 2.55 X 1.00 X 3.00	= 29.45 m2	
Pagar teras	= 0.80 X 1.95 X 1.00 X 2.00	= 3.12 m2	
	= 0.80 X 3.20 X 1.00 X 8.00	= 20.48 m2	
Diatas blk gantung	= 0.55 x 1.95 x 2.00 x 1.00	= 2.15 m2	
	= 0.55 x 3.20 x 8.00 x 1.00	= 14.08 m2	
Pengurangan			
Kusen pintu	= -2.62 X 1.72 X 2.00 X 1.00	= -9.01 m2	
	= -2.62 X 0.92 X 1.00 X 1.00	= -2.41 m2	
jendela	= -2.44 X 1.38 X 10.00 X 1.00	= -33.67 m2	
BV	= -0.52 X 0.98 X 1.00 X 1.00	= -0.51 m2	
	= -0.52 X 0.72 X 1.00 X 1.00	= -0.37 m2	
		= 327.82 m2	327.82 m2
<u>PEKERJAAN ACIAN</u>			
LANTAI 1			
Kolom beton 30/40	= 0.40 x 4.00 x 9.00 x 1.00	= 14.40 m2	
	= 0.40 x 3.50 x 6.00 x 4.00	= 33.60 m2	
	= 0.30 x 4.00 x 1.00 x 3.00	= 3.60 m2	
	= 0.30 x 3.50 x 1.00 x 3.00	= 3.15 m2	
	= 0.15 x 3.50 x 2.00 x 6.00	= 6.30 m2	
Kolom beton 40/60	= 0.40 x 3.50 x 2.00 x 6.00	= 16.80 m2	
	= 0.40 x 3.50 x 1.00 x 6.00	= 8.40 m2	
	= 0.40 x 4.00 x 1.00 x 6.00	= 9.60 m2	
Balok 30/40	= 0.40 x 2.00 x 1.00 x 1.00	= 0.80 m2	
	= 0.40 x 3.10 x 2.00 x 1.00	= 2.48 m2	
	= 0.40 x 2.60 x 1.00 x 1.00	= 1.04 m2	
	= 0.40 x 3.10 x 8.00 x 2.00	= 19.84 m2	
		= 120.01 m2	120.01 m2

LANTAI 2					
Kolom beton 30/40	=	0.40 x 3.50 x 5.00 x 8.00	=	56.00	m2
	=	0.40 x 3.50 x 1.00 x 2.00	=	2.80	m2
	=	0.30 x 4.00 x 9.00 x 3.00	=	32.40	m2
	=	0.30 x 3.50 x 1.00 x 3.00	=	3.15	m2
	=	0.15 x 3.50 x 2.00 x 6.00	=	6.30	m2
Kolom beton 40/60	=	0.40 x 3.50 x 2.00 x 6.00	=	16.80	m2
	=	0.40 x 3.50 x 1.00 x 6.00	=	8.40	m2
	=	0.40 x 4.00 x 1.00 x 6.00	=	9.60	m2
Balok 30/40	=	0.40 x 2.00 x 1.00 x 1.00	=	0.80	m2
	=	0.40 x 3.10 x 2.00 x 1.00	=	2.48	m2
	=	0.40 x 2.60 x 1.00 x 1.00	=	1.04	m2
	=	0.40 x 3.10 x 8.00 x 2.00	=	19.84	m2
			=	159.61	m2
				159.61	m2
LANTAI 3					
Kolom beton 30/40	=	0.40 x 3.50 x 2.00 x 3.00	=	8.40	m2
	=	0.40 x 3.50 x 1.00 x 2.00	=	2.80	m2
	=	0.30 x 4.00 x 1.00 x 3.00	=	3.60	m2
	=	0.30 x 3.50 x 1.00 x 3.00	=	3.15	m2
	=	0.15 x 3.50 x 2.00 x 6.00	=	6.30	m2
Kolom beton 40/60	=	0.40 x 3.50 x 2.00 x 6.00	=	16.80	m2
	=	0.40 x 3.50 x 1.00 x 6.00	=	8.40	m2
	=	0.40 x 4.00 x 1.00 x 6.00	=	9.60	m2
Balok 30/40	=	0.40 x 2.00 x 1.00 x 1.00	=	0.80	m2
	=	0.40 x 3.10 x 2.00 x 1.00	=	2.48	m2
	=	0.40 x 2.60 x 1.00 x 1.00	=	1.04	m2
	=	0.40 x 3.10 x 8.00 x 2.00	=	19.84	m2
			=	83.21	m2
				83.21	m2
PEKERJAAN BENANGAN					

LANTAI 1					
KOLOM	=	4.90 x 2.00 x 4.00	=	39.20	m'
	=	4.90 x 2.00 x 8.00	=	78.40	m'
	=	3.60 x 3.00 x 2.00	=	21.60	m'
	=	3.60 x 2.00 x 3.00 x 2.00	=	43.20	m'
	=	3.60 x 2.00 x 6.00 x 2.00	=	86.40	m'
	=	3.60 x 4.00 x 8.00	=	115.20	m'
LUBANG KUSEN PJ 1	=	(2.46 + 2.58 x 2.00) x 2.00 x 1.00	=	15.24	m'
J 1	=	(1.22 + 2.36) x 2.00 x 2.00 x 13.00	=	186.16	m'
P 1	=	(0.88 + 2.04 x 2.00) x 2.00 x 1.00	=	9.92	m'
P 2	=	(0.70 + 2.00 x 2.00) x 2.00 x 4.00	=	37.60	m'
BV 1	=	(0.48 + 0.48) x 2.00 x 2.00	=	3.84	m'
BV 2	=	(0.48 + 0.68) x 2.00 x 1.00	=	2.32	m'
BALOK INDUK	=	3.00 x 2.00 x 2.00	=	12.00	m'
BALOK ANAK	=	3.10 x 2.00 x 8.00	=	49.60	m'
BALOK GANTUNG	=	3.20 x 3.00 x 8.00	=	76.80	m'
DINDING TANGGA	=	4.20 x 2.00 x 2.00 x 2.00	=	33.60	m'
	=	1.15 x 2.00 x 2.00	=	4.60	m'
	=	2.50 x 2.00 x 1.00	=	5.00	m'
			=	820.68	m'
LANTAI 2					
KOLOM	=	4.90 x 2.00 x 4.00	=	39.20	m'
	=	4.90 x 2.00 x 8.00	=	78.40	m'
	=	3.60 x 3.00 x 2.00	=	21.60	m'
	=	3.60 x 2.00 x 3.00 x 2.00	=	43.20	m'
	=	3.60 x 2.00 x 6.00 x 2.00	=	86.40	m'
	=	3.60 x 4.00 x 8.00	=	115.20	m'
LUBANG PINTU PJ 1	=	(2.58 + 2.38 x 2.00) x 2.00 x 2.00	=	29.36	m'
J 1	=	(0.92 + 2.36) x 2.00 x 2.00 x 10.00	=	131.20	m'
P 1	=	(0.88 + 2.04 x 2.00) x 2.00 x 2.00	=	19.84	m'

$P 2 = (0.70 + 2.00 \times 2.00) \times 2.00 \times 3.00$	= 28.20 m'	
$BV 1 = (0.48 + 0.48) \times 2.00 \times 2.00$	= 3.84 m'	
$BV 2 = (0.48 + 0.68) \times 2.00 \times 1.00$	= 2.32 m'	
BALOK GANTUNG = 3.20 x 3.00 x 8.00	= 76.80 m'	
DINDING TANGGA = 4.20 x 2.00 x 2.00 x 2.00	= 33.60 m'	
= 1.15 x 2.00 x 2.00	= 4.60 m'	
= 2.50 x 2.00 x 1.00	= 5.00 m'	
	= 718.76 m'	718.76 m'
LANTAI 3		
KOLOM = 4.90 x 2.00 x 4.00	= 39.20 m'	
= 4.90 x 2.00 x 8.00	= 78.40 m'	
= 3.60 x 3.00 x 2.00	= 21.60 m'	
= 3.60 x 2.00 x 3.00 x 2.00	= 43.20 m'	
= 3.60 x 2.00 x 6.00 x 2.00	= 86.40 m'	
= 3.60 x 4.00 x 8.00	= 115.20 m'	
LUBANG PINTU PJ 1 = (2.58 + 2.38 x 2.00) x 2.00 x 2.00	= 29.36 m'	
J 1 = (0.92 + 2.36) x 2.00 x 2.00 x 12.00	= 157.44 m'	
P 1 = (0.88 + 2.04 x 2.00) x 2.00 x 1.00	= 9.92 m'	
P 2 = (0.70 + 2.00 x 2.00) x 2.00 x 3.00	= 28.20 m'	
BV 1 = (0.48 + 0.48) x 2.00 x 2.00	= 3.84 m'	
BV 2 = (0.48 + 0.68) x 2.00 x 1.00	= 2.32 m'	
BALOK GANTUNG = 3.20 x 3.00 x 8.00	= 76.80 m'	
DINDING TANGGA = 4.20 x 2.00 x 2.00 x 2.00	= 33.60 m'	
= 1.15 x 2.00 x 2.00	= 4.60 m'	
= 2.50 x 2.00 x 1.00	= 5.00 m'	
	= 735.08 m'	
<u>PEKERJAAN KUSEN PINTU, JENDELA DAN PENGUNCI</u>		
LANTAI 1		
TYPE PJ 1		

Kusen	$= 2.38 \times 4.00 + 0.51 \times 6.00 + 1.40 \times 2.00$	
	0.40×1.00	= 15.78 m1
Daun pintu	$= 0.70 \times 1.90 \times 2.00$	= 2.66 m2
Daun jendela	$= 0.51 \times 1.85 \times 2.00$	= 1.89 m2
Kaca bening 5 mm	$= 0.42 \times 0.53 \times 2.00$	= 0.45 m2
	$= 0.42 \times 0.70 \times 2.00$	= 0.59 m2
	$= 0.42 \times 1.75 \times 2.00$	= 1.47 m2
	$= 0.60 \times 0.85 \times 2.00 \times 2.00$	= 2.04 m2
		= 4.54 m2
Karet sponing		
	$= (0.40 \times 2.00 + 0.51 \times 2.00) \times 2.00$	= 3.64 m'
	$= (0.40 \times 2.00 + 0.68 \times 2.00) \times 2.00$	= 4.32 m'
	$= (0.58 \times 2.00 + 0.83 \times 2.00) \times 2.00$	= 5.64 m'
	$= (0.39 \times 2.00 + 1.79 \times 2.00) \times 2.00$	= 8.72 m'
		= 22.32 m'
TYPE P 1		
Kusen	$= 1.94 \times 2.00 + 0.80 \times 1.00$	= 4.68 m'
Daun Pintu Double Multiplek	$= 0.80 \times 1.90 \times 1.00$	= 1.52 m2
Kaca bening 5 mm	$= 0.22 \times 0.32$	= 0.07 m2
		= 0.07 m2
Karet sponing	$= 0.20 \times 2.00 + 0.30 \times 2.00$	= 1.00 m'

	CAT DAUN PINTU	
	$= 0.80 \times 1.90 \times 2.00$	$= 3.04 \text{ m}^2$
TYPE P 2 (Pintu aluminium KM/WC)	$= 3.00 \text{ bh}$	
	TYPE P 3	
	Kusen $= 1.98 \times 2.00 + 0.70 \times 2.00$	$= 5.36 \text{ m}'$
Daun Pintu Double Multiplek	$= 0.70 \times 1.90 \times 2.00$	$= 2.66 \text{ m}^2$
	Kaca Bening 5 mm $= 0.22 \times 0.32 \times 2.00$	$= 0.14 \text{ m}^2$
	CAT DAUN PINTU	
	$= 0.70 \times 1.90 \times 2.00 \times 2.00$	$= 5.32 \text{ m}^2$
	TYPE J 1	
	Kusen $= 1.22 \times 4.00 + 0.70 \times 3.00 \times 2.00 + 0.80$	$= 11.48 \text{ m}'$
	Daun jendela $= 0.40 \times 0.70 \times 2.00 + 0.70 \times 0.70 \times 2.00$	$= 1.54 \text{ m}^2$
	Kaca Bening 5 mm $= 0.42 \times 0.72 \times 2.00 + 0.42 \times 0.82$	$= 0.95 \text{ m}^2$
	$= 0.64 \times 0.66 \times 2.00 + 0.72 \times 0.82$	$= 1.44 \text{ m}^2$
		$= 2.38 \text{ m}^2$

$\text{Karet sponing} = (0.32 + 0.62) \times 2.00 \times 2.00 + (0.40 + 0.80) \times 2.00 \times 2.00 = 6.16 \text{ m}'$	
$= (0.62 + 0.62) \times 2.00 \times 2.00 + (0.70 + 0.80) \times 2.00 \times 2.00 = 7.96 \text{ m}'$	
$= 14.12 \text{ m}'$	
TYPE BV 1	
$\text{Kusen} = 0.48 \times 2.00 + 0.40 \times 2.00 = 1.76 \text{ m}'$	
Kaca bening 5 mm	
$= 0.31 \times 0.42 \times 2.00 = 0.26 \text{ m}^2$	
Karet sponing	
$= (0.30 \times 2.00 + 0.40) \times 2.00 = 2.00 \text{ m}'$	
TYPE BV 2	
$\text{Kusen} = 0.48 \times 2.00 + 0.70 \times 2.00 = 2.36 \text{ m}'$	
Kaca bening 5 mm	
$= 0.31 \times 0.62 \times 2.00 = 0.38 \text{ m}^2$	
Karet sponing	
$= (0.30 \times 2.00 + 0.60) \times 2.00 = 2.40 \text{ m}'$	
PINTU SHAFT	
$\text{Kusen} = 1.46 \times 2.00 + 0.60 = 3.52 \text{ m}'$	

$= 13.16 \text{ m}'$	
Cat tembok = $0.29 \times 1.20 \times 2.00 + 0.60 \times 1.20 \times 2.00 = 2.14 \text{ m}^2$	
TYPE PR 3	
Kusen = $1.28 \times 2.00 + 1.20 \times 3.00 + 1.92 \times 2.00 = 10.00 \text{ m}'$	
Kalsiboard 6 mm = $0.32 \times 1.22 \times 2.00 + 0.62 \times 1.22 \times 2.00 = 2.29 \text{ m}^2$	
Karet sponing = $(0.30 + 1.20) \times 2.00 \times 2.00 = 6.00 \text{ m}'$	
= $(0.60 + 1.20) \times 2.00 \times 2.00 = 7.20 \text{ m}'$	
$= 13.20 \text{ m}'$	
Cat tembok = $0.30 \times 1.20 \times 2.00 + 0.60 \times 1.20 \times 2.00 = 2.16 \text{ m}^2$	
TYPE PR 4	
Kusen = $1.28 \times 2.00 + 1.20 \times 3.00 + 2.02 \times 2.00 = 10.20 \text{ m}'$	
Kalsiboard 6 mm = $0.37 \times 1.22 \times 2.00 + 0.62 \times 1.22 \times 2.00 = 2.42 \text{ m}^2$	
Karet sponing = $(0.35 + 1.20) \times 2.00 \times 2.00 = 6.20 \text{ m}'$	
= $(0.60 + 1.20) \times 2.00 \times 2.00 = 7.20 \text{ m}'$	
$= 13.40 \text{ m}'$	
Cat tembok = $0.35 \times 1.20 \times 2.00 + 0.60 \times 1.20 \times 2.00 = 2.28 \text{ m}^2$	

TYPE PR 5	
Kusen	= 1.28 x 2.00 + 0.55 x 2.00 = 3.66 m'
Kalsiboard 6 mm	= 0.57 x 1.22 x 2.00 = 1.39 m'
Karet sponing	= (0.55 + 1.20) x 2.00 = 3.50 m ²
Cat tembok	= 0.55 x 1.20 x 2.00 = 1.32 m ²
TYPE PR 6	
Kusen	= 3.45 x 2.00 + 3.37 x 3.00 + 1.42 + 2.40 = 22.07 m'
	= 0.24 x 2.00 + 0.60 x 2.00 x 2.00 + 0.60 + 0.84 = 6.04 m'
	= 28.11 m'
Kalsiboard 6 mm	= 0.24 x 1.18 x 2.00 + 0.24 x 1.29 x 2.00 = 1.19 m ²
	= 0.24 x 0.84 x 2.00 = 0.40 m ²
	= (0.60 x 1.18 x 2.00 + 0.60 x 1.29 x 2.00) = 5.93 m ²
	= 0.60 x 0.84 x 2.00 x 2.00 = 2.02 m ²
	= 0.49 x 0.60 x 2.00 = 0.59 m ²
	= 0.49 x 0.20 x 2.00 = 0.20 m ²
	= 0.84 x 0.20 x 2.00 = 0.34 m ²
	= 10.65 m ²
Karet sponing	= (0.24 + 1.18) x 2.00 + (0.24 + 1.29) x 2.00 = 5.90 m'
	= (0.24 + 0.84) x 2.00 = 2.16 m'
	= (0.60 + 1.18) x 2.00 x 2.00 = 7.12 m'
	= (0.60 + 1.29) x 2.00 x 2.00 = 7.56 m'
	= (0.60 + 0.84) x 2.00 x 3.00 = 8.64 m'

Cat tembok = 2.00 x 3.45 x 2.00	= 13.80 m ²
	= 13.80 m ²
TYPE PR 8	
Kusen = 3.45 x 2.00 + 3.37 x 14.00 + 9.32 x 2.00	= 72.72 m'
= 0.48 x 2.00 x 2.00 + 0.60 x 13.00 x 2.00	= 17.52 m'
	= 90.24 m'
Kalsiboard 6 mm = 3.45 x 9.40 x 2.00	
	= 64.86 m ²
	= 64.86 m ²
Karet sponing = (0.40 + 1.20) x 2.00 x 2.00 x 2.00	= 12.80 m'
= (0.60 + 1.20) x 2.00 x 13.00 x 2.00	= 93.60 m'
= (0.89 + 0.48) x 2.00 x 2.00 x 1.00	= 5.48 m'
= (0.89 + 0.60) x 2.00 x 13.00 x 1.00	= 38.74 m'
	= 150.62 m'
Cat tembok = 3.45 x 9.40 x 2.00	
	= 64.86 m ²
	= 64.86 m ²
TYPE PR 9	
Kusen = 3.45 x 5.00 + 2.33 x 2.00	= 21.91 m'
= 0.60 x 4.00 x 4.00 + 0.60 x 3.00 + 0.20	= 12.00 m'
	= 33.91 m'
Kalsiboard 6 mm = 0.93 x 1.42 x 2.00 + 2.62 x 3.45 x 2.00	
	= 20.72 m ²

	= 20.72 m²
Karet sponing = (0.60 + 1.20) x 2.00 x 4.00 x 2.00	= 28.80 m'
= (0.60 + 0.93) x 2.00 x 5.00 x 1.00	= 15.30 m'
= (0.60 + 0.40) x 2.00 x 1.00 x 1.00	= 2.00 m'
= (0.20 + 0.93) x 1.00 x 1.00 x 1.00	= 1.13 m'
= (0.20 + 0.40) x 1.00 x 1.00 x 1.00	= 0.60 m'
	= 47.83 m'
Cat tembok = 0.93 x 1.42 x 2.00 + 2.62 x 3.45 x 2.00	= 20.72 m ²
	= 20.72 m²
TYPE PR 9	
Kusen = 3.45 x 5.00 + 1.42 x 2.00 + 0.20 x 3.00	= 20.69 m'
= 0.60 x 4.00 x 4.00 + 0.60 x 3.00	= 11.40 m'
	= 32.09 m'
Kalsiboard 6 mm = 0.93 x 1.42 x 2.00 + 2.40 x 3.45 x 2.00	= 19.20 m ²
	= 19.20 m²
Karet sponing = (0.20 + 0.93) x 2.00 x 1.00 x 1.00	= 2.26 m'
= (0.20 + 0.40) x 2.00 x 1.00 x 1.00	= 1.20 m'
= (0.60 + 0.93) x 2.00 x 1.00 x 1.00	= 3.06 m'
= (0.40 + 0.60) x 2.00 x 1.00 x 1.00	= 2.00 m'
= (0.60 + 0.93) x 2.00 x 4.00 x 1.00	= 12.24 m'
= (0.60 + 1.20) x 2.00 x 4.00 x 2.00	= 28.80 m'
	= 49.56 m'
Pengecatan kalsiboard	
= 0.93 x 1.42 x 2.00 + 2.40 x 3.45 x 2.00	= 19.20 m ²

	= 19.20 m²
TYPE PR 9'	
Kusen	$= 3.45 \times 5.00 + 1.42 \times 2.00 + 0.24 \times 3.00 = 20.81 \text{ m}'$
	$= 0.60 \times 4.00 \times 4.00 + 0.60 \times 3.00 = 11.40 \text{ m}'$
	= 32.21 m'
Kalsiboard 6 mm	$= 0.93 \times 1.42 \times 2.00 + 2.40 \times 3.45 \times 2.00 = 19.20 \text{ m}^2$
	= 19.20 m²
Karet sponing	$= (0.20 + 0.93) \times 2.00 \times 1.00 \times 1.00 = 2.26 \text{ m}'$
	$= (0.20 + 0.40) \times 2.00 \times 1.00 \times 1.00 = 1.20 \text{ m}'$
	$= (0.60 + 0.93) \times 2.00 \times 1.00 \times 1.00 = 3.06 \text{ m}'$
	$= (0.40 + 0.60) \times 2.00 \times 1.00 \times 1.00 = 2.00 \text{ m}'$
	$= (0.60 + 0.93) \times 2.00 \times 4.00 \times 1.00 = 12.24 \text{ m}'$
	$= (0.60 + 1.20) \times 2.00 \times 4.00 \times 2.00 = 28.80 \text{ m}'$
	= 49.56 m'
Pengecatan kalsiboard	
	$= 0.93 \times 1.42 \times 2.00 + 2.40 \times 3.45 \times 2.00 = 19.20 \text{ m}^2$
	= 19.20 m²
TYPE PR 10	
Kusen	$= 3.45 \times 7.00 + 0.24 \times 4.00 \times 2.00 + 0.60 = 35.67 \text{ m}'$
Kalsiboard 6 mm	$= 1.55 \times 9.40 \times 2.00 = 29.14 \text{ m}^2$
	= 29.14 m²

Karet sponing = (0.24 + 1.20) x 2.00 x 2.00 x 2.00	= 11.52 m'
= (0.60 + 1.20) x 2.00 x 4.00 x 2.00	= 28.80 m'
= (0.60 + 0.89) x 2.00 x 4.00 x 1.00	= 11.92 m'
	= 52.24 m'
Pengecatan kalsiboard	
= 1.55 x 9.40 x 2.00	= 29.14 m2
	= 29.14 m2
TYPE PR 11	
Rangka Besi C 150.50.20.3.2 = 40.60 kg	
= 9.40 x 2.00 x 2.00 x 3.38	= 127.21 kg
= 1.18 x 2.00 x 9.00 x 3.38	= 71.86 kg
	= 199.08 kg
Penggantung besi L. 30.30.3 = 8.16 kg	
= 2.92 x 2.00 x 1.36 + 4.67 x 2.00 x 1.36	= 20.64 kg
Kalsiboard 6 mm	
= 1.55 x 9.40 x 2.00	= 29.14 m2
Pintu panel = 0.60 x 2.38 x 7.00 x 2.00	
	= 19.99 m2
Stoper Kayu 5/8	
= 0.05 x 0.08 x 2.53	= 0.01 m3
Rel Gantung Wina 6 mtr	= 2.00 set

Engsel pintu	= 7.00 x 3.00 x 2.00	= 42.00 set
Kunci pintu	= 2.00	set
Handel pintu	= 4.00	set
Grendel pintu	= 7.00 x 2.00 x 2.00	= 28.00 bh
Cat tenbok =	1.48 x 9.40 x 2.00	= 27.82 m ²
Cat kayu =	19.99 x 2.00	= 39.98 m ²
RILLING TANGGA		
PIPA Ø 3'	= 1.10 X 4.00 + 4.20	= 8.60 M'
PIPA Ø 2'	= 1.40 X 2.00 X 3.00	= 8.40 M'
PIPA Ø 1,5' = (0.83 X 2.00 + 0.98 + 1.68) x 3.00		= 12.96 M'
LUASAN PAGAR TANGGA		
	= 1.10 X 3.60 X 2.00 + 1.10 X 0.60	= 8.58 M ²

<u>PEKERJAAN LANTAI KERAMIK</u>			
LANTAI 1			
Keramik 40x40			
Dalam ruangan	= 9.85 x 24.35	= 239.85 m ²	
Bawah tangga/Dapur	= 2.15 x 3.85 - 0.60 x 2.50	= 6.78 m ²	
Selasar	= 2.40 x 28.00	= 67.20 m ²	
Trap tangga	= 0.30 x 1.15 x 12.00 x 2.00 + 1.15 X 2.85	= 11.56 m ²	
	= 0.18 x 1.15 x 12.00 x 2.00	= 4.97 m ²	
Depan KM/WC	= 2.10 x 6.35	= 13.34 m ²	
		= 343.69 m²	343.69 m²
Lantai KM/WC			
	= 1.60 x 2.15 x 1.00 - 0.40 x 0.50 x 1.00	= 3.24 m²	
	= 1.35 x 2.15 x 1.00 - 0.40 x 0.50 x 1.00	= 2.70 m²	
		= 5.94 m²	5.94 m²
Keramik Dinding 20x25 KM/WC			
	= (1.60 x 1.75 x 2.00 + 2.15 x 1.75 x 2.00	= 22.05 m ²	
	= (1.35 x 1.75 x 2.00 + 2.15 x 1.75 x 2.00	= 11.03 m ²	
Pengurangan pintu	= -0.82 x 1.75 x 3.00	= -4.31 m ²	
		= 28.77 m²	28.77 m²
Keramik meja dapur 30x30			
	= 0.60 x 3.35 - 0.10 x 0.35 - 0.10 X 0.10	= 1.97 m ²	1.97 m²
	0.95 2.38		
Keramik didning meja dapur 25x40			
	= 0.95 x 3.35	= 3.18 m ²	3.18 m²
LANTAI 2			

Keramik 40x40					
Dalam ruangan	=	9.85 x 24.35	=	239.85	m2
Selasar	=	2.25 x 28.75	=	64.69	m2
Depan KM/WC	=	2.40 x 5.25	=	12.60	m2
Trap tangga	=	0.30 x 1.15 x 12.00 x 2.00 + 1.15 x 2.85	=	11.56	m2
	=	0.18 x 1.15 x 12.00 x 2.00	=	4.97	m2
			=	333.66	m2
				333.66	m2
Keramik dinding 25x40					
	= (1.35 x 1.75 x 2.00 + 2.15 x 1.75 x 2.00	=	11.03	m2
	= (1.60 x 1.75 x 2.00 + 2.15 x 1.75 x 2.00	=	22.05	m2
Pengurangan pintu	=	-0.82 x 1.75 x 3.00	=	-4.31	m2
			=	28.77	m2
				28.77	m2
Lantai KM/WC					
	=	1.60 x 2.15 x 1.00 - 0.40 x 0.50 x 1.00	=	3.24	m2
	=	1.35 x 2.15 x 1.00 - 0.40 x 0.50 x 1.00	=	2.70	m2
			=	5.94	m2
				5.94	m2
LANTAI 3					
Keramik 30x30					
Dalam ruangan	=	9.85 x 24.35	=	239.85	m2
Selasar	=	2.25 x 28.75	=	64.69	m2
Depan KM/WC	=	2.40 x 5.25	=	12.60	m2
Pengurangan lobang tangga	=	-2.65 x 4.60	=	-12.19	m2
			=	317.14	m2
				317.14	m2
Keramik dinding 20x25					
	= (1.35 x 1.75 x 2.00 + 2.15 x 1.75 x 2.00	=	11.03	m2
	= (1.60 x 1.75 x 2.00 + 2.15 x 1.75 x 2.00	=	22.05	m2

Pengurangan pintu = $-0.82 \times 1.75 \times 3.00$	= -4.31 m ²	
	= 28.77 m ²	28.77 m ²
Lantai KM/WC		
	= $1.60 \times 2.15 \times 1.00 - 0.40 \times 0.50 \times 1.00$	= 3.24 m ²
	= $1.35 \times 2.15 \times 1.00 - 0.40 \times 0.50 \times 1.00$	= 2.70 m ²
	= 5.94 m ²	5.94 m ²
PEKERJAAN PLAFOND		
LANTAI 1		
Dalam ruangan = 9.85×24.35	= 239.85 m ²	
Selasar = 2.25×27.85	= 62.66 m ²	
KM/WC = $1.35 \times 2.15 \times 4.00$	= 11.61 m ²	
Depan KM/WC = 1.30×6.00	= 7.80 m ²	
	= 321.92 m ²	321.92 m ²
LANTAI 2		
Dalam ruangan = 9.85×24.35	= 239.85 m ²	
Selasar = 2.25×27.85	= 62.66 m ²	
KM/WC = $1.35 \times 2.15 \times 4.00$	= 11.61 m ²	
Depan KM/WC = 1.30×4.50	= 5.85 m ²	
	= 319.97 m ²	319.97 m ²
LANTAI 3		
Dalam ruangan = 9.85×24.35	= 239.85 m ²	
Selasar = 2.40×27.85	= 66.84 m ²	
KM/WC = $1.35 \times 2.15 \times 4.00$	= 11.61 m ²	
Depan KM/WC = 1.30×4.50	= 5.85 m ²	
Over steak = $1.50 \times 31.00 \times 2.00 + 1.50 \times 10.00 \times 2.00$	= 123.00 m ²	
	= 447.15 m ²	447.15 m ²

<u>LIST GYPSUM</u>			
LANTAI 1			
Dalam ruangan	= (9.85 + 24.35) x 2.00	= 68.40	m'
Depan KM/WC	= (1.30 + 6.00) x 2.00	= 14.60	m'
Dlm KM/WC	= (1.60 + 2.15) x 2.00 x 2.00	= 15.00	m'
	= (1.35 + 2.15) x 2.00 x 1.00	= 7.00	m'
Selasar	= (2.25 + 27.85) x 2.00	= 60.20	m'
		= 165.20	m' 165.20 m'
LANTAI 2			
Dalam ruangan	= (1.73 + 2.41) x 2.00 x 4.00 x 2.00	= 66.08	m'
	= (2.96 + 9.85) x 2.00	= 25.62	m'
	= (6.92 + 9.85) x 2.00	= 33.54	m'
	= (3.46 + 3.41) x 2.00 x 4.00	= 54.92	m'
	= 6.35 + 10.41 + 2.96 + 3.50 x 2.00 + 6.91	= 33.62	m'
Depan KM/WC	= (1.30 + 5.25) x 2.00	= 13.10	m'
Dlm KM/WC	= (1.60 + 2.15) x 2.00 x 2.00	= 15.00	m'
	= (1.35 + 2.15) x 2.00 x 1.00	= 7.00	m'
Selasar	= (2.25 + 27.85) x 2.00	= 60.20	m'
		= 309.08	m' 309.08 m'
LANTAI 3			
Dalam ruangan	= (9.85 + 10.41) x 2.00	= 40.51	m'
	= (9.85 + 13.91) x 2.00	= 47.51	m'
Depan KM/WC	= (1.30 + 5.25) x 2.00	= 13.10	m'
Dlm KM/WC	= (1.60 + 2.15) x 2.00 x 2.00	= 15.00	m'
	= (1.35 + 2.15) x 2.00 x 1.00	= 7.00	m'
Selasar	= (2.25 + 27.85) x 2.00	= 60.20	m'
Over stek	= (1.50 + 3.10) x 2.00 + (1.50 + 10.00) x 2.00	= 32.20	m'
		= 215.52	m' 215.52 m'

<u>PEKERJAAN PENGECATAN</u>			
LANTAI 1			
Tembok Dalam			
	$= 3.35 \times 9.85 \times 2.00 + 3.35 \times 24.35 \times 2.00$	= 229.14	m ²
	Depan KM/WC $= 3.35 \times 1.30 \times 1.00 + 3.35 \times 5.25 \times 1.00$	= 76.59	m ²
Dinding	KM/WC bag. Luar $= 3.35 \times 4.50 \times 1.00 + 3.35 \times 1.50 \times 1.00$	= 75.75	m ²
	Kolom 60/60 $= (0.60 \times 4.00) \times 3.55 \times 9.00 \times 2.00$	= 153.36	m ²
	Kolom 30/30 $= (0.30 \times 4.00) \times 3.55 \times 9.00 \times 1.00$	= 38.34	m ²
	Kolom 30/30 $= (0.30 \times 4.00) \times 3.55 \times 9.00 \times 1.00$	= 38.34	m ²
	Bawah tangga $= 1.30 \times 2.13 + 2.13 \times 3.50 \times 0.50$	= 6.50	m ²
	Plat tangga bag. Bawah $= 1.25 \times 4.25 + 1.30 \times 2.50$	= 8.56	m ²
	Plat tangga bag. Atas $= 1.25 \times 3.90$	= 4.88	m ²
	Bawah tangga atas $= 3.45 \times 4.00 \times 0.50$	= 6.90	m ²
	Tembok dapur $= 3.35 \times 4.00 + 3.35 \times 2.30$	= 21.11	m ²
	$= 2.05 + 4.00 \times 3.40 + 1.50 \times 2.15$	= 13.51	m ²
	2		
Tembok	KM/WC bag. Dalam $= (1.35 + 2.15) \times 2.00 \times 3.00$	= 21.00	m ²
		= 693.97	m ²
Pengurangan			
	Kusen Type J 1 $= (1.22 \times 2.36) \times 2.00 \times 13.00$	= 74.86	m ²
	Kusen Type BV 1 $= 0.48 \times 0.48 \times 2.00 \times 2.00$	= 0.92	m ²
	Kusen Type BV 2 $= 0.48 \times 0.68 \times 2.00 \times 1.00$	= 0.65	m ²
	Kusen Type PJ 1 $= 1.93 \times 2.58 \times 2.00$	= 9.97	m ²
	Kusen Type P 1 $= 0.88 \times 1.94 \times 2.00 \times 2.00$	= 6.83	m ²
	Kusen pintu KM/WC $= 0.70 \times 2.00 \times 4.00 \times 2.00$	= 11.20	m ²
	Keramik dindng $= (1.35 + 2.15) \times 2.00 \times 1.75 \times 4.00$	= 49.00	m ²
		= 153.43	m ²
	Jumlah cat tembok dlm lt. 1 $= 693.97 - 153.43$	= 540.54	540.54 m²

LANTAI 2					
Tembok Dalam					
	=	3.35 x 9.85 x 2.00 + 3.35 x 24.35 x 2.00	=	229.14	m2
Depan KM/WC	=	3.35 x 1.30 x 1.00 + 3.35 x 5.25 x 1.00	=	76.59	m2
Dinding KM/WC bag. Luar	=	3.35 x 4.50 x 1.00 + 3.35 x 1.50 x 1.00	=	75.75	m2
Kolom 30/40 Teras	=	(0.30 + 0.40) x 2.00 x 4.00 x 9.00	=	50.40	m2
Kolom 30/40 Samping	=	(0.15 x 2.00 + 0.40 x 2.00) x 4.00 x 2.00	=	8.80	m2
Kolom 40/60	=	(0.40 x 2.00 + 0.45 x 2.00) x 4.00 x 2.00	=	13.60	m2
Bawah tangga	=	1.30 x 2.13 + 2.13 x 3.50 x 0.50	=	6.50	m2
Plat tangga bag. Bawah	=	1.25 x 4.25 + 1.30 x 2.50	=	8.56	m2
Plat tangga bag. Atas	=	1.25 x 3.90	=	4.88	m2
Bawah tangga atas	=	3.45 x 4.00 x 0.50	=	6.90	m2
Tembok KM/WC bag. Dalam	=	(1.35 + 2.15) x 2.00 x 3.00	=	21.00	m2
			=	502.12	m2
Pengurangan					
Kusen Type J 1	=	(0.72 x 1.34 + 0.40 x 1.17 + 1.71 x 2.00	=	58.24	m2
Kusen Type BV 1	=	0.48 x 1.32 x 2.00 x 2.00	=	2.53	m2
Kusen Type BV 2	=	0.48 x 0.68 x 2.00 x 1.00	=	0.65	m2
Kusen Type P 1	=	0.88 x 1.94 x 2.00	=	3.41	m2
Kusen Type PJ 1	=	2.38 x 2.58 x 2.00 x 2.00	=	24.56	m2
Kusen pintu KM/WC	=	0.70 x 2.00 x 3.00 x 2.00	=	8.40	m2
Keramik dindng	=	(1.35 + 2.15) x 2.00 x 1.75 x 3.00	=	36.75	m2
Pintu KM/WC	=	0.70 x 0.25 x 3.00	=	0.53	m2
			=	135.08	m2
Jumlah cat tembok dlm lt. 2	=	502.12 - 135.08	=	367.04	m2
				367.04	m2

LANTAI 3					
Tembok Dalam					
	=	3.35 x 9.85 x 2.00 + 3.35 x 24.35 x 2.00	=	229.14	m2
Depan KM/WC	=	3.35 x 1.30 x 1.00 + 3.35 x 5.25 x 1.00	=	76.59	m2
Dinding KM/WC bag. Luar	=	3.35 x 4.50 x 1.00 + 3.35 x 1.50 x 1.00	=	75.75	m2
Kolom 30/40 Teras	=	(0.30 + 0.40) x 2.00 x 4.00 x 9.00	=	50.40	m2
Kolom 30/40 Samping	=	(0.15 x 2.00 + 0.40 x 2.00) x 4.00 x 2.00	=	8.80	m2
Kolom 40/60	=	(0.40 x 2.00 + 0.45 x 2.00) x 4.00 x 2.00	=	13.60	m2
Bawah tangga	=	1.30 x 2.13 + 2.13 x 3.50 x 0.50	=	6.50	m2
Tembok KM/WC bag. Dalam	=	(1.35 + 2.15) x 2.00 x 3.00	=	21.00	m2
			=	481.78	m2
Pengurangan					
Kusen Type J 1	=	(0.72 x 1.34 + 0.40 x 1.17 + 1.71 x 2.00	=	63.09	m2
Kusen Type BV 1	=	0.48 x 1.32 x 2.00 x 2.00	=	2.53	m2
Kusen Type BV 2	=	0.48 x 0.68 x 2.00 x 1.00	=	0.65	m2
Kusen Type P 1	=	0.88 x 1.94 x 2.00	=	3.41	m2
Kusen Type PJ 1	=	2.38 x 2.58 x 2.00	=	12.28	m2
Kusen pintu KM/WC	=	0.70 x 2.00 x 3.00 x 2.00	=	8.40	m2
Keramik dindng	=	(1.35 + 2.15) x 2.00 x 1.75 x 3.00	=	36.75	m2
Pintu KM/WC	=	0.70 x 0.25 x 3.00	=	0.53	m2
			=	127.65	m2
Jumlah cat tembok dlm lt. 3	=	481.78 - 127.65	=	354.13	m2
<u>PEKERJAAN ATAP</u>					
Base Plat	=	0.20 x 0.30 x 0.012 x ##### x 22.00	=	124.34	kg
Baut Angkur	=	4.00 x 0.60 x 2.98 x 22.00	=	157.48	kg

	$= 29.65 \times 2.00 \times 1.00 \times 3.38$	$= 200.63$	kg	
	$= 29.65 \times 2.00 \times 1.00 \times 3.38$	$= 200.63$	kg	
	$= 6.18 \times 2.00 \times 1.00 \times 3.38$	$= 41.82$	kg	
	$= 8.17 \times 2.00 \times 1.00 \times 3.38$	$= 55.28$	kg	
	$= 10.17 \times 2.00 \times 1.00 \times 3.38$	$= 68.82$	kg	
	$= 12.16 \times 2.00 \times 1.00 \times 3.38$	$= 82.28$	kg	
	$= 14.15 \times 2.00 \times 1.00 \times 3.38$	$= 95.75$	kg	
	$= 15.41 \times 2.00 \times 1.00 \times 3.38$	$= 104.27$	kg	
		$= 2,287.40$	kg	2,287.40 kg
	besi siku 70.70.7	$= 44.28$	kg	
	besi siku 100.100.10	$= 90.60$	kg	
Dudukan gording L. 100.100.10	$= 0.10 \times 9.00 \times 7.00 \times 2.00 \times 15.10$	$= 190.26$	kg	
	$= 0.10 \times 6.00 \times 3.00 \times 2.00 \times 15.10$	$= 54.36$	kg	
		$= 244.62$	kg	244.62 kg
	besi siku 50.50.5	$= 22.68$	kg	
Ikatan Anging Besi beton 16 mm	$= 18.96$	kg		
	$= 2.00 \times 8.90 \times 2.00 \times 4.00 \times 1.58$	$= 224.99$	kg	
	Plat Buhul 10 mm			
	$= 0.01 \times 0.30 \times 0.46 \times 11.00 \times 2.00 \times #####$	$= 238.33$	kg	
	$= 0.01 \times 0.10 \times 0.46 \times 11.00 \times 6.00 \times #####$	$= 238.33$	kg	
	$= 0.01 \times 0.14 \times 0.46 \times 11.00 \times 2.00 \times #####$	$= 111.22$	kg	
		$= 587.87$	kg	587.87 kg
	Plat pengaku 6 mm			
	$= 0.05 \times 0.20 \times 0.006 \times ##### \times 2.00 \times 5.00$	$= 28.93$	kg	
	$= 0.05 \times 0.20 \times 0.006 \times ##### \times 2.00 \times 3.00$	$= 9.92$	kg	

	= 38.85 kg	38.85 kg
Ikatan Angin Ø 16		
= 6.72 x 2.00 x 4.00 x 2.00 x 1.58	= 169.62 kg	169.62 kg
Trek stang Ø 12		
= 1.15 x 7.00 x 6.00 x 2.00 x 0.89	= 85.72 kg	
= 0.75 x 1.00 x 6.00 x 2.00 x 0.89	= 7.99 kg	
= 1.15 x 4.00 x 6.00 x 2.00 x 0.89	= 48.98 kg	
= 0.75 x 1.00 x 6.00 x 2.00 x 0.89	= 7.99 kg	
	= 150.67 kg	150.67 kg
Batang Tarik Ø 19		
= 12.15 x 7.00 x 2.22	= 189.20 kg	189.20 kg
Usuk dan Reng Galvalum		
= $\frac{22.60 + 31.15}{2} \times 8.95 \times 2.00$	= 481.06 m ²	
= $\frac{5.00 + 15.75}{2} \times 5.70 \times 2.00$	= 118.28 m ²	
	= 599.34 m ²	599.34 m²
Papan Rueter / Bubung Sejenis		
= 22.60 + 7.38 x 4.00	= 52.12 m'	52.12 m'
Talang Seng Bj.LS. 30		
= 31.05 x 2.00 + 15.50 x 2.00 + 15.50 x 1.00	= 108.60 m'	108.60 m'

Talang Tegak PVC 3"	
$= (13.35 + 1.50 + 0.10 + 1.50) \times 3.00 \times 2.00 = 98.70 \text{ m}'$	
$= (13.35 + 1.50 + 0.10 + 1.50) \times 1.00 \times 1.00 = 16.45 \text{ m}'$	
$= 115.15 \text{ m}'$	115.15 m'
<u>PEKERJAAN SAL. AIR HUJAN</u>	
$= 29.50 + 4.00 + 15.40$	$= 48.90 \text{ M}'$
Bak Kontrol =	
$4.00 \times 1.00 + 3.00$	$= 7.00 \text{ bh}$
<u>INST. AIR DAN SANITAIR</u>	
Pipa air bersih 3/4"	
Lantai 1	$= 0.80 + 1.00 + 1.70 + 3.90 + 0.50 \times 3.00 = 29.90 \text{ m}'$
Lantai 2	$= 1.67 + 3.90 + 3.72 + 1.24 + 0.60 + 0.85 = 13.68 \text{ m}'$
Lantai 3	$= 1.67 + 3.90 + 3.72 + 1.24 + 0.60 + 0.85 = 13.68 \text{ m}'$
Pipa air kotor 3"	
Lantai 1	$= 1.02 \times 3.00 + 2.25 + 6.56 + 18.22 + 1.18 = 41.17 \text{ m}'$
Lantai 2	$= 4.68 + 9.12 + 1.84 \times 3.00 + 0.85 \times 3.00 = 50.07 \text{ m}'$

Lantai 3	= 4.68 + 9.12 + 1.84 x 3.00 + 0.85 x 3.00 = 50.07 m'
Pipa air kotor 4"	
Lantai 1	= 1.14 x 3.00 + 7.91 + 12.21 = 23.54 m'
Lantai 2	= 0.88 x 3.00 + 4.22 + 0.61 + 0.85 x 3.00 = 10.02 m'
Lantai 3	= 0.88 x 3.00 + 4.22 + 0.61 + 0.85 x 3.00 = 10.02 m'

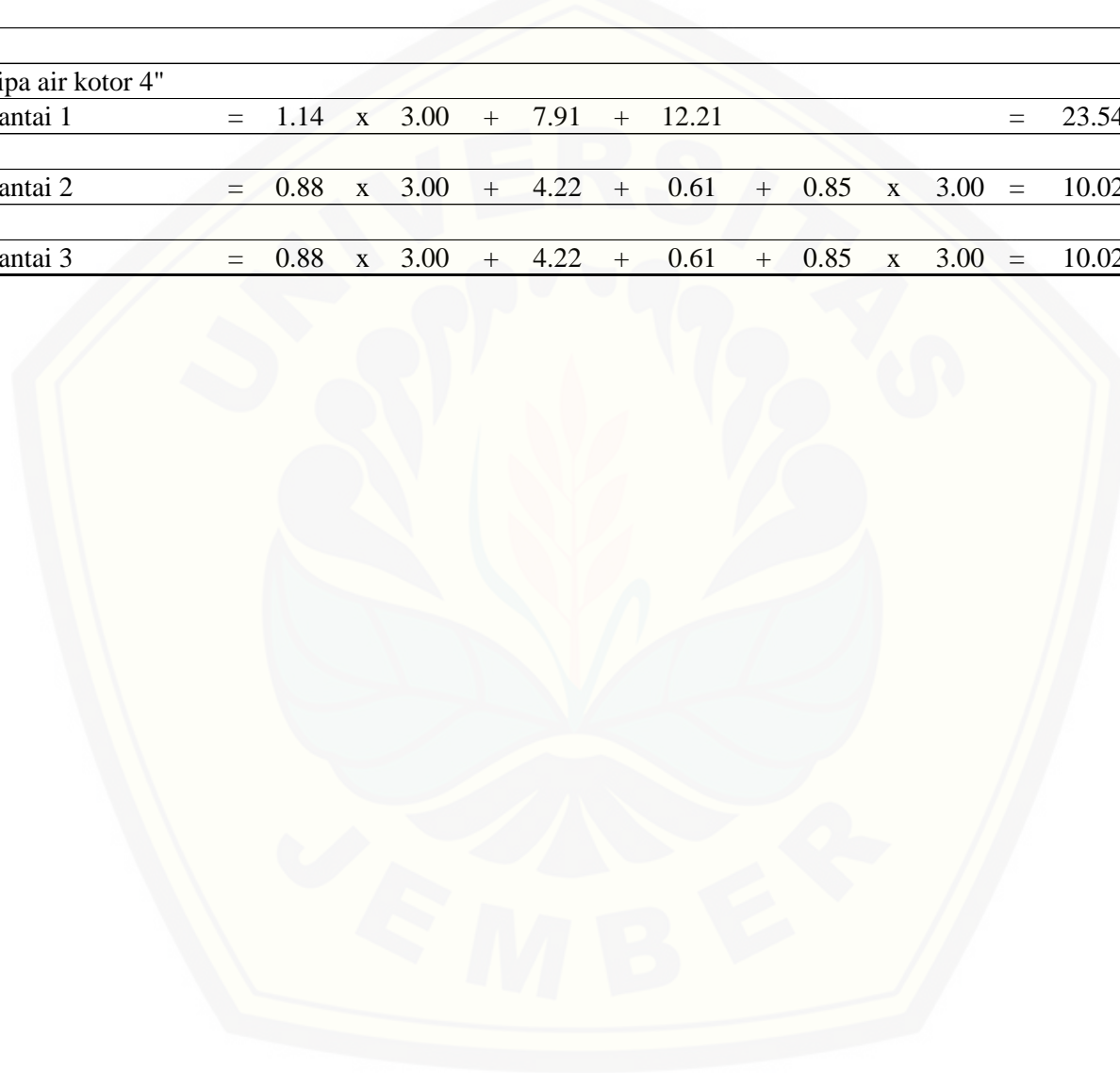

3. Survey Harga Material dan Upah Pekerja



HARGA MATERIAL BANGUNAN KABUPATEN JEMBER 2017

No	JENIS BAHAN	SATUAN	HARGA SATUAN
I JENIS BAHAN BANGUNAN BAHAN PENUTUP ATAP & PLAFON			
1	Asbes Gelombang Besar tebal 5 mm (2.50 x 0.92 m)	lbr	88,000.00
2	Asbes gelombang kecil tebal 5 mm (2.25 x 0.92 m)	lbr	72,000.00
3	Asbes gelombang kecil tebal 5 mm (1.80 x 0.92 m)	lbr	27,000.00
4	Asbes gelombang kecil tebal 4 mm (2.70 x 1.05 m)	lbr	47,000.00
5	Asbes wuwung stel gelombang 0.92 mm	set	19,500.00
6	Eternit 100x100 cm " Kerang / Gresik "	lbr	16,000.00
7	Genteng Palentong /vlampress	bj	1,700.00
8	Genteng palentong super	bh	15,100.00
9	Genteng Nok Palentong /vlampress	bj	7,500.00
10	Genteng bubung kodok / karangpilang	bj	16,100.00
11	Genteng Beton	bj	5,500.00
12	Genteng Metal Uk Efektif 90 x 77 cm T=0,40 TCT	lbr	95,000.00
13	Nok genteng beton	bj	9,500.00
14	Nok Steel gelombang	lbr	13,500.00
15	Genteng kodok / karang pilang	bj	4,700.00
16	Seng gelombang BJLS 30 (0.8 x 1.5)	m'	65,000.00
17	Seng gelombang BJLS 40 (0.8 x 1.5)	m'	67,000.00
18	Seng Plat 3' x 6' BJLS 28	lbr	60,000.00
19	Teakwood tebal 4 mm (1.22 x 2.44)	lbr	70,000.00
20	Teakwood tebal 4 mm (1.10 x 2.10)	lbr	82,000.00
21	Plywood tebal 4 mm (1.22 x 2.44)	lbr	85,000.00
22	Plywood tebal 9 mm (1.22 x 2.44)	lbr	98,000.00
24	Triplek tebal 4 mm (0.90 x 2.00)	lbr	52,000.00
25	Triplek tebal 4 mm (1.22 x 2.44)	lbr	52,000.00
26	Formite penjaga jarak bekisting / spacer	bh	14,000.00
27	Gypsum board 12 mm (120x240) "Jayaboard"	lbr	91,000.00
28	Gypsum board 9 mm (120x240) "Jayaboard"	lbr	77,000.00
29	Kalsiboard tebal 4,5 mm	m2	70,000.00
30	Profil alluminium " T " Indal / kusen aluminium 3"	m'	60,000.00
31	Profil alluminium " T " Indal / kusen aluminium 4"	m'	81,000.00
32	Fiberglass gelombang (180 x 90) cm	lbr	51,000.00
33	List gypsum profil	m'	24,000.00
34	Talang karet 90	m'	12,500.00
35	Talang karet 60	m'	10,000.00
36	Kawat Ayam	roll	150,000.00
37	kawat Harmonika	m2	32,000.00
38	Kawat ramset	m'	3,500.00
39	Alumunium Foil	roll	300,000.00
40	Glasswool	roll	200,000.00
41	Jointing	Kg	18,000.00
42	Cotton Tape	Roll	24,000.00

43 HPL	lbr	215,000.00
44 Wallpaper "STANDART"	roll	240,000.00
45 Wallpaper "DELUXE"	roll	350,000.00
46 Spandek	m2	50,000.00
47 Kalsiplank	m'	12,000.00
II BAHAN MENGGUNAKAN KAYU		
1 Dolken kayu Ø 8-10/400 cm	Btg	28,000.00
2 Kayu kelas I (Balok)	m3	9,000,000.00
3 Kayu kelas I (Papan)	m3	10,000,000.00
4 Kayu kelas II (Balok)	m3	5,000,000.00
5 Kayu kelas II (Papan)	m3	6,000,000.00
6 Kayu kelas III (Balok)	m3	3,000,000.00
7 Kayu kelas III (Papan)	m3	3,500,000.00
8 Kayu 5/7	m ³	2,500,000.00
9 Kayu cetakan / Bekisting	m ³	2,000,000.00
10 Perancah kayu	m ³	1,700,000.00
11 Ijuk	kg	1,500.00
12 Bambu Ø 6 - 10/600 cm	btg	13,000.00
III BAHAN MENGGUNAKAN BATU / PASIR & SEMEN		
1 Batu bata merah	bh	400.00
2 Batu kali pecah 3/5	m ³	125,000.00
3 Batu pecah 5/7	m ³	130,000.00
4 Batu pecah 2/3	m ³	130,000.00
5 Batu pecah 1/2	m ³	130,000.00
6 Batu kali pecah 3/5	m ³	140,000.00
7 Batu gunung pecah 15/20	m ³	140,000.00
8 Batu tempel	m ²	40,000.00
9 Batu kerikil beton	m ³	130,000.00
10 Batu bobos uk. (10x 20 x 1,5) cm	bh	5,000.00
11 Batu Candi uk. (20 x 40 x 1,5) cm	bh	12,000.00
12 Pasir cor / beton (Pasir Kali)	m ³	140,000.00
13 Pasir pasang (Pasir Kali)	m ³	140,000.00
14 pasir urug / Timbunan	m ³	72,000.00
15 Pasir Pasang Ex. Lumajang	m ³	180,000.00
16 Semen berwarna yiyitan	kg	6,000.00
17 Semen PC (Portland Cement) / Semen Gresik (50 Kg)	kg	2,000.00
18 Semen tiga roda (50 Kg)	kg	2,000.00
19 Semen PC (Portland Cement) / Semen Gresik (40 Kg)	kg	2,000.00
20 Semen putih	kg	2,000.00
21 Semen merah	m ³	140,000.00
22 Kapur pasang	m ³	8,000.00
23 Tanah urug	m ³	75,000.00
24 Tanah sirtu / Urung	m ³	65,000.00
25 Tanah liat	m ³	65,000.00
IV BAHAN MENGGUNAKAN BESI / LOGAM		

1	Besi begel / baut	kg	10,500.00
2	Besi beton polos	kg	8,000.00
3	Besi beton ulir	kg	8,000.00
4	Besi beton diameter 12 mm, 12 m	ljr	64,000.00
5	Besi beton diameter 10 mm, 12 m	ljr	40,000.00
6	Besi beton diameter 8 mm, 12 m	ljr	30,000.00
7	Besi beton diameter 6 mm, 12 m	ljr	20,000.00
8	Pipa besi GI diameter 0,50" Medium B	m`	17,500.00
9	Pipa besi GI diameter 0,75" Medium B	m`	20,000.00
10	Pipa besi GI diameter 1" Medium B	m`	30,000.00
11	Pipa besi GI diameter 1,5" Medium B	m`	50,000.00
12	Pipa besi GI diameter 2" Medium B	m`	75,000.00
13	Pipa besi GI diameter 2,5" Medium B	m`	99,500.00
14	Pipa besi GI diameter 3" Medium B	m`	128,500.00
15	Pipa besi GI diameter 4" Medium B	m`	186,000.00
16	Pipa besi GI diameter 6" Medium B	m`	527,000.00
17	Pipa besi GI diameter 0,50"	m`	25,500.00
18	Pipa besi GI diameter 0,75"	m`	34,500.00
19	Pipa besi GI diameter 1"	m`	50,900.00
20	Pipa besi GI diameter 1,5"	m`	87,500.00
21	Pipa besi GI diameter 2"	m`	175,000.00
22	Pipa besi GI diameter 2,5"	m`	225,000.00
23	Pipa besi GI diameter 3"	m`	330,000.00
24	Pipa besi GI diameter 4"	m`	550,000.00
25	Pipa besi GI diameter 6"	m`	570,000.00
26	Pipa hollow profil 70 x 70 x 1.6 mm	m`	60,000.00
27	Pipa hollow profil 40 x 40 x 1.4 mm	m`	28,000.00
28	Pipa hollow profil 20 x 40 x 1.4 mm	m`	20,000.00
29	hollow rangka plafond 20 x 40 mm	ljr	45,000.00
30	Pipa Stenlessteel daimeter 1"	ljr	11,000.00
31	Pipa Stenlessteel daimeter 1 1/2", tbl. 1	ljr	12,500.00
32	Pipa Stenlessteel daimeter 2", tbl. 1	ljr	160,000.00
33	Pipa Stenlessteel daimeter 3", tbl. 1	ljr	190,000.00
34	Pipa Stenlessteel daimeter 4", tbl. 1	ljr	240,000.00
35	Besi plat 4 x 8 tebal 2 mm	Kg	6,500.00
36	Besi plat bordes 4" x 8" tebal 3 mm	kg	6,000.00
37	Besi strip tebal 5 mm	kg	15,000.00
38	Kawat ikat beton	kg	15,000.00
39	Kawat Las Listrik	kg	26,000.00
40	Kawat Duri	kg	10,500.00
41	Jendela nako lengkap	daun	35,000.00
42	Pintu lipat / harmonika 1m x 2m	bh	120,000.00
43	Skrup fixer	bh	500.00
44	Metal stud 3"	m'	25,000.00
45	Metal furring	m2	100,000.00
46	Runner U	m'	12,000.00
47	Curtain wall	m'	40,000.00
48	Tutup curtain wall	m'	20,000.00

49 Profil H	m'	12,500.00
50 Profil 1/2 H	m'	10,500.00
51 wf 100.50.5.7mm	kg	7,000.00
52 wf 125.60.6.8mm	kg	7,000.00
53 wf 150.75.5.7mm	kg	70,000.00
54 wf 175.90.5.8mm	kg	7,000.00
55 wf 200.100.5,5.8mm	kg	7,000.00
56 wf 250.125.6.9mm	kg	7,000.00
57 wf 300.150.6,5.9mm	kg	7,000.00
58 wf 350.175.7.11mm	kg	7,000.00
59 wf 400.200.8.13mm	kg	7,000.00
60 Plat bertulang 6mm	kg	7,000.00
61 Plat plendes kuda-kuda 8mm	kg	7,000.00
62 Plat sepatu kolom 10mm	kg	7,000.00
63 Trek hordeng bs 10mm	kg	10,000.00
64 Tali angin bs 12mm	kg	10,000.00
65 Spansecruw M-16	unit	45,000.00
66 Baut angkur 12mm	bj	25,000.00
67 Baut kuda-kuda 1/2 x 1 1/2 inc	bj	2,000.00
68 Baut hordeng & trek hordeng	bj	1,500.00
69 CNP.150. 50. 2,3mm	kg	12,000.00
70 Driling secruw 3 inc	pcs	1,000.00
71 C75.70 -baja ringan	m	10,500.00
72 C75.75 -baja ringan	m	11,500.00
73 C75.95 -baja ringan	m	13,500.00
74 Reng -baja ringan	m	32,000.00
75 Screw	m	500.00
76 Dynabolt	pcs	4,000.00
77 Plat bracing	m	12,000.00
V BAHAN UNTUK LANTAI		
1 Conblock Paving persegi abu - abu tebal 6 cm kasar	m2	85,000.00
2 Conblock Paving persegi abu - abu tebal 8 cm kasar	m2	95,000.00
3 Lantai keramik 30 x 30 cm setara Roman/Milan	bh	7,000.00
4 Lantai keramik 40 x 40 cm setara Roman/Milan	bh	12,000.00
5 Lantai keramik 60 x 60 cm setara Roman/Milan	bh	8,000.00
6 Keramik Dinding 25 x 40 cm setara Roman/Milan	bh	13,000.00
7 Lantai keramik Kasar 30 x 30 cm setara Roman/Milan	bh	8,000.00
9 Granit tile 40 x 40 cm (polos)	bh	25,000.00
10 Granit tile 60 x 60 cm (polos)	bh	26,000.00
11 Kanstin beton 15x30x50	bh	49,000.00
12 Terawang (Roster)	bh	5,000.00
13 Perquet kayu kelas I	m ²	160,000.00
14 Step Nois Jenis Karet	m'	30,000.00
15 Lantai Batu Alam	m ²	120,000.00
VI BAHAN UNTUK PENGECATAN		
1 Cat kayu/besi 'EMCo"	kg	70,000.00

2	Cat meni (besi / kayu) 'PEDANG"	kg	22,000.00
3	Cat tembok interior Setara Catylac	kg	35,000.00
4	Cat tembok eksterior NIPPON	kg	51,000.00
5	Propan Alkali	kg	55,000.00
6	Propan	kg	75,500.00
7	mortar	kg	2,000.00
8	Politur	ltr	55,000.00
9	Politur jadi	ltr	75,000.00
10	Lem kayu "Fox"	kg	11,500.00
11	Thinner A / minyak cat	ltr	18,500.00
12	Thinner B / minyak cat	ltr	20,000.00
13	Sabun	kg	12,600.00
14	Teak oil	ltr	4,000.00
15	Plamir	kg	7,000.00
16	Ampelas	lbr	4,000.00
17	Kuas 4"	bh	22,000.00
18	Cat tembok eksterior Setara Movilex	kg	89,000.00
19	Coating Batu Alam	ltr	74,000.00
20	Water proofing setara Aqua proof atau No Drop	ltr	47,500.00
VII BAHAN PENGGANTUNG DAN PENGUNCI			
1	Engsel jendela "Nylon"	ps	16,000.00
2	Engsel pintu "Nylon"	bh	30,000.00
3	Engsel Pintu Temperd	bh	30,000.00
4	Kunci Pintu Temperd	bh	100,000.00
5	Handle Pintu Temperd	bh	200,000.00
6	Handle Pintu Biasa	bh	100,000.00
7	Handle Jendela	bh	10,000.00
8	Grendel pernikal	bh	7,000.00
9	Grendel tanam	bh	60,000.00
10	Kunci selot setara Totti	bh	130,000.00
11	Kunci tanam	bh	140,000.00
12	Kunci pintu 2x putar	bh	110,000.00
13	Kunci pintu 1x putar	bh	100,000.00
14	Hak angin 4 mm (terkait)	bj	8,000.00
15	Karet Sponing	m'	2,500.00
16	Kait angin lurus setel maju mundur	bh	3,000.00
VIII BAHAN UNTUK KM / WC / URINOIR			
1	Closet duduk putih porselin komplit setara KIA / INA	bh	370,000.00
2	Closet duduk putih porselin komplit setara America Standart	bh	485,000.00
3	Closet jongkok porselin warna setara KIA / INA	bh	135,000.00
4	Steal tape	bh	3,500.00
5	Wastafel setara KIA / INA	bh	200,000.00
6	Kran air	bh	24,000.00
7	Water drain + assesories	set	25,100.00
8	Floor drain	bh	74,600.00
9	Air	ltr	400.00

10 Urinoir setara ina	bh	1,503,900.00
11 Pintu PVC lengkap	bh	170,000.00
12 Jet Spry	bh	125,000.00
13 Bak Cuci Stanles steel	bh	413,000.00
14 Tandon Air Fiberglass 1000 m3 ex. Profile	bh	875,000.00
15 Jet Pump 1,5 PK	bh	2,500,000.00
IX BAHAN JENIS KACA		
1 Kaca polos tb. 3 mm	m ²	88,000.00
2 Kaca polos tb. 5 mm	m ²	125,000.00
3 Kaca polos tb. 8 mm	m ²	151,000.00
4 Kaca polos tb. 12 mm	m ²	310,000.00
5 Kaca rayban tb. 3 mm	m ²	55,000.00
6 Kaca rayban tb. 5 mm	m ²	71,000.00
7 Kaca rayban tb. 8 mm	m ²	137,000.00
8 Kaca rayban tb. 12 mm	m ²	245,000.00
9 Kaca es tb. 5 mm	m ²	185,000.00
10 Kaca Temperd tb. 12 mm	m ²	485,000.00
11 Kaca one way (Top Soel) tb. 5 mm	m ²	320,000.00
12 Sealant	tube	48,200.00
13 Glass Block	bh	13,500.00
X BAHAN BETON CETAKAN		
1 Buis beton diameter 40 cm	bh	109,200.00
2 Buis beton diameter 50 cm	bh	205,100.00
3 Buis beton U 20 cm	bh	78,000.00
4 Buis beton U 30 cm	bh	84,600.00
XI BAHAN PLASTIK PIPA PVC		
1 Pipa PVC 3/4" type AW	m'	23,000.00
2 Pipa PVC 1/2" type AW	m'	17,500.00
3 Pipa PVC 1" type AW	m'	32,000.00
4 Pipa PVC 1 1/2" type AW	m'	57,500.00
5 Pipa PVC 2" type AW	m'	72,000.00
6 Pipa PVC 2 1/2" type AW	m'	105,000.00
7 Pipa PVC 3" type AW	m'	140,000.00
8 Pipa PVC 4" type AW	m'	225,000.00
9 Keni PVC 2"	bh	4,500.00
10 Klem PVC	bh	4,000.00
11 Lem PVC	bh	6,500.00
12 Sambungan Knee AW 1/2"	bh	2,000.00
13 Sambungan Knee AW 3/4"	bh	2,500.00
14 Sambungan Knee AW 1"	bh	3,500.00
15 Sambungan Knee AW 1 1/4"	bh	4,000.00
16 Sambungan Knee AW 1 1/2"	bh	4,000.00
17 Sambungan Knee AW 2"	bh	4,500.00
18 Sambungan Knee D 1 1/4"	bh	15,000.00
19 Talang Kotak PVC	m`	42,500.00

20 Hak penggantung talang	bh	4,000.00
21 Tutup samping talang	bh	2,500.00
22 Sambungan pipa tanpa lobang	bh	5,000.00
23 Sambungan pipa dengan lobang	bh	8,000.00
24 Pipa paralon 5/8"	ljr	4,500.00
XII BAHAN JENIS PAKU		
1 Paku asbes	kg	25,000.00
2 Paku reng	kg	13,500.00
3 Paku triplek	kg	16,000.00
4 Paku usuk	kg	11,000.00
5 Paku pancing	kg	28,000.00
6 Baut dynabolt diameter 10 mm panjang 3"	bh	14,520.00
7 Paku sekrup 3.5"	kg	55,000.00
7 Paku sekrup 3.5"	Bh	800.00
8 Paku sekrup 2"	kg	10,500.00
9 Paku sekrup 1"	kg	108,500.00
10 Paku Gypsum	kg	30,000.00
XIII BAHAN PERALATAN LISTRIK		
1 Stop kontak setara "Broco"	bh	13,000.00
2 Skakelar setara Tunggal "Broco"	bh	11,000.00
3 Skakelar Ganda setara "Broco"	bh	14,500.00
4 Sekering kas MCM 10 Amp	bh	70,000.00
5 Lampu pijar 25, 40, 75 / 220 V	bh	20,000.00
6 Lampu LED Bohlamp 7 watt	bh	63,800.00
7 Lampu LED Bohlamp 9 watt	bh	66,000.00
8 Lampu LED Bohlamp 12 watt	bh	100,100.00
9 Lampu LED Bohlamp 14 watt	bh	111,100.00
10 Lampu TL 20 W / 220 V Komplit "Philips"	bh	135,000.00
11 Lampu TL 40 W / 220 V Komplit "Philips"	bh	165,000.00
12 Lampu TL LED Slimline 9 Watt/60 cm	bh	111,100.00
13 Lampu TL LED Slimline 18 Watt/120 cm	bh	171,600.00
14 Lampu TL 2 x 20 W / 220 V Komplit setara "SAKA"	bh	408,980.00
15 Lampu TL 2 x 40 W / 220 V Komplit setara "SAKA"	bh	474,960.00
16 Lampu Downlight PL 20 W /220 V Komplit setara "Philips"	bh	90,750.00
17 Lampu SL 18 Watt	bh	44,000.00
18 Kabel NYA 1 x 2,5 mm	m'	2,500.00
19 Isolator	bh	6,600.00
20 Las Dop	bh	700.00
21 Fiting Plafond "Broco"	bh	6,200.00
22 T.Dos PVC	bh	2,400.00
23 Panel Box	set	37,800.00
24 MCB 10 Amp	bh	70,400.00
25 Miniswitch 32 Amp	set	317,900.00
26 Armatuur lampu pijar 25Watt Kualitas I	Bh	18,700.00
27 AC. Window 2 PK	Bh	13,435,500.00
28 AC. Window 1,5 PK	Bh	7,166,100.00

29 AC. Window 1 PK	Bh	6,269,000.00
30 AC. Window 1/2 PK	Bh	3,646,800.00
31 AC Casset/Celling 1,5 PK	Bh	13,134,000.00
32 AC Casset/Celling 2 PK	Bh	14,531,000.00
33 Exhaust Fan Ex Jepang	Bh	984,100.00
34 Kipas angin Gantung Ex Jepang	Bh	825,000.00





HARGA UPAH PEKERJA KABUPATEN JEMBER 2017

NO.	PEKERJA	KODE	UPAH (Rp/hari)
1	Mandor lapangan	L04	80,000.00
2	Kepala tukang	L03	75,000.00
3	Tukang kayu	L02	70,000.00
4	Tukang batu	L02	70,000.00
5	Tukang besi	L02	70,000.00
6	Tukang pipa air	L02	70,000.00
7	Tukang listrik	L02	70,000.00
8	Tukang aluminium	L02	70,000.00
9	Tukang cat	L02	70,000.00
10	Tukang las	L02	70,000.00
11	Pekerja	L01	65,000.00
12	Buruh	L13	60,000.00
13	Mekanik	L08	125,350.00
14	Pembantu Mekanik	L09	83,250.00
15	Operator	L04	124,650.00
16	Pembantu operator	L05	82,700.00
17	Sopir	L06	125,350.00
18	Pembantu sopir	L07	83,250.00
19	Penjaga Malam	L14	46,000.00

NO.	JENIS PEKERJAAN	KODE	PAH (Rp / hari)
1	Biaya langsirah bahan kelokasi sulit per 100 m`		
a	yang satuan M3		10,000.00
b	Yang satuan M2		250.00
c	Semen PC yang satuan Zak		1,500.00
d	Yang satuan Kg		85.00
2	Pengeboran Darat Wilayah Kecamatan		
a	Kaliwates, Ajung, Rambipuji, Bangsalsari	M'	260,000.00
b	Tanggul, Semboro, Umbulsari, Sumberbaru	M'	325,000.00
c	Jenggawah, Ambulu, Wuluhan, Balung	M'	292,500.00
d	Panti, Sukorambi, Patrang	M'	325,000.00
e	Arjasa, Jelbuk, Kalisat, Ledokombo, Sukowono, Sumberjambe	M'	351,000.00
f	Sempolan, Mayang, Mumbulsari, Tempurejo, Pakusari	M'	338,000.00
g	Puger, Gumukmas, Kencong, Jombang	M'	335,100.00
h	Sumbersari	M'	390,000.00



4. Analisa Harga Satuan



ANALISA SATUAN PEKERJAAN KABUPATEN JEMBER 2017

Pekerjaan Persiapan

NO.	JENIS PEKERJAAN	BAHAN	UPAH	JUMLAH	BULAT
1	2	3	4	5	6
1	Analisa SNI Dinas PU. Cipta Karya dan Tata Ruang				
	1 m' pagar sementara dari seng gelombang tinggi 2 meter				
	Bahan				
	1.250 Btg Dolken kayu Ø 8-10/400 cm Rp 28,000.00	35,000.00			
	2.500 Kg Semen Portland Rp 2,000.00	5,000.00			
	1.200 Lbr Seng gelombang 3" - 6" BJLS 28 Rp 65,000.00	78,000.00			
	0.005 m ³ Pasir beton (Pasir Kali) Rp 140,000.00	700.00			
	0.009 m ³ Koral beton Rp 130,000.00	1,170.00			
	0.072 m ³ Kayu 5/7 Rp 2,500,000.00	180,000.00			
	0.060 Kg Paku biasa 2" - 5" Rp 16,000.00	960.00			
	0.450 Kg Meni besi Rp 22,000.00	9,900.00			
	Upah				
	0.400 Oh Pekerja Rp 65,000.00		26,000.00		
	0.200 Oh Tukang kayu Rp 70,000.00		14,000.00		
	0.020 Oh Kepala tukang Rp 75,000.00		1,500.00		
	0.020 Oh Mandor Rp 80,000.00		1,600.00		
		310,730.00	43,100.00	353,830.00	353,800.00
2	Analisa SNI Dinas PU. Cipta Karya dan Tata Ruang				
	1 m' pagar sementara dari kawat duri tinggi 1,8 meter				
	Bahan				
	1.250 Btg Dolken kayu Ø 8-10/400 cm Rp 28,000.00	35,000.00			
	2.000 Kg Semen Portland Rp 2,000.00	4,000.00			
	25.000 Kg Kawat Duri Rp 10,500.00	262,500.00			
	0.005 m ³ Pasir beton (Pasir Kali) Rp 140,000.00	700.00			

	0.009 m ³	Koral beton	Rp	130,000.00	1,170.00			
	0.060 Kg	Paku biasa 2" - 5"	Rp	16,000.00	960.00			
	Upah							
	0.200 Oh	Pekerja	Rp	65,000.00		13,000.00		
	0.300 Oh	Tukang kayu	Rp	70,000.00		21,000.00		
	0.020 Oh	Kepala tukang	Rp	75,000.00		1,500.00		
	0.020 Oh	Mandor	Rp	80,000.00		1,600.00		
					304,330.00	37,100.00	341,430.00	341,400.00
1	Analisa SNI Dinas PU. Cipta Karya dan Tata Ruang							
	1 m' Pengukuran dan Pas. Bouwplank							
	Bahan							
	0.012 Btg	Kayu 5/7	Rp	2,500,000.00	30,000.00			
	0.020 Kg	Paku biasa 2" - 5"	Rp	16,000.00	320.00			
	0.007 m ³	Papan Kayu 3/20 kayu kl. III	Rp	3,500,000.00	24,500.00			
	Upah							
	0.100 Oh	Pekerja	Rp	65,000.00		6,500.00		
	0.100 Oh	Tukang kayu	Rp	70,000.00		7,000.00		
	0.010 Oh	Kepala tukang	Rp	75,000.00		750.00		
	0.005 Oh	Mandor	Rp	80,000.00		400.00		
					54,820.00	14,650.00	69,470.00	69,400.00
4	Analisa SNI Dinas PU. Cipta Karya dan Tata Ruang							
	1 m ² pembuatan kantor sementara dengan lantai plesteran							
	Bahan							
	1.250 Btg	Dolken kayu Ø 8-10/400 cm	Rp	28,000.00	35,000.00			
	0.180 m ³	Kayu	Rp	2,500,000.00	450,000.00			
	0.080 Kg	Paku biasa	Rp	16,000.00	1,280.00			
	1.100 Kg	Besi strip	Rp	15,000.00	16,500.00			
	35.000 Kg	Semen portland	Rp	2,000.00	70,000.00			
	0.150 m ³	Pasir pasang	Rp	140,000.00	21,000.00			
	0.100 m ³	Pasir beton (Pasir Kali)	Rp	140,000.00	14,000.00			

	0.150 m ³	Koral beton	Rp	130,000.00	19,500.00			
	30.000 Bh	Bata merah	Rp	400.00	12,000.00			
	0.250 Lbr	Seng plat	Rp	60,000.00	15,000.00			
	0.200 Bh	Jendela nako	Rp	35,000.00	7,000.00			
	0.080 m ²	Kaca polos	Rp	125,000.00	10,000.00			
	0.150 Bh	Kunci Tanam	Rp	140,000.00	21,000.00			
	0.060 Lbr	Plywood 4mm	Rp	85,000.00	5,100.00			
	Upah							
	2.000 Oh	Pekerja	Rp	65,000.00		130,000.00		
	2.000 Oh	Tukang kayu	Rp	70,000.00		140,000.00		
	1.000 Oh	Tukang batu	Rp	70,000.00		70,000.00		
	0.300 Oh	Kepala tukang	Rp	75,000.00		22,500.00		
	0.050 Oh	Mandor	Rp	80,000.00		4,000.00		
					697,380.00	366,500.00	1,063,880.00	1,063,800.00
2	Analisa SNI Dinas PU. Cipta Karya dan Tata Ruang							
	1 m ² membersihkan lapangan dan perataan							
	Upah							
	0.100 Oh	Pekerja	Rp	65,000.00		6,500.00		
	0.050 Oh	Mandor	Rp	80,000.00		4,000.00		
						10,500.00	10,500.00	10,500.00
3	Analisa SNI Dinas PU. Cipta Karya dan Tata Ruang							
	1 m ³ bongkaran beton bertulang							
	Upah							
	13.334 Oh	Pekerja	Rp	65,000.00		866,710.00		
	0.666 Oh	Mandor	Rp	80,000.00		53,280.00		
						919,990.00	919,990.00	919,900.00
4	Analisa SNI Dinas PU. Cipta Karya dan Tata Ruang							
	1 m ³ bongkaran dinding tembok bata merah							
	Upah							
	6.667 Oh	Pekerja	Rp	65,000.00		433,355.00		
	0.333 Oh	Mandor	Rp	80,000.00		26,640.00		

			459,995.00	459,995.00	459,900.00
--	--	--	------------	------------	-------------------

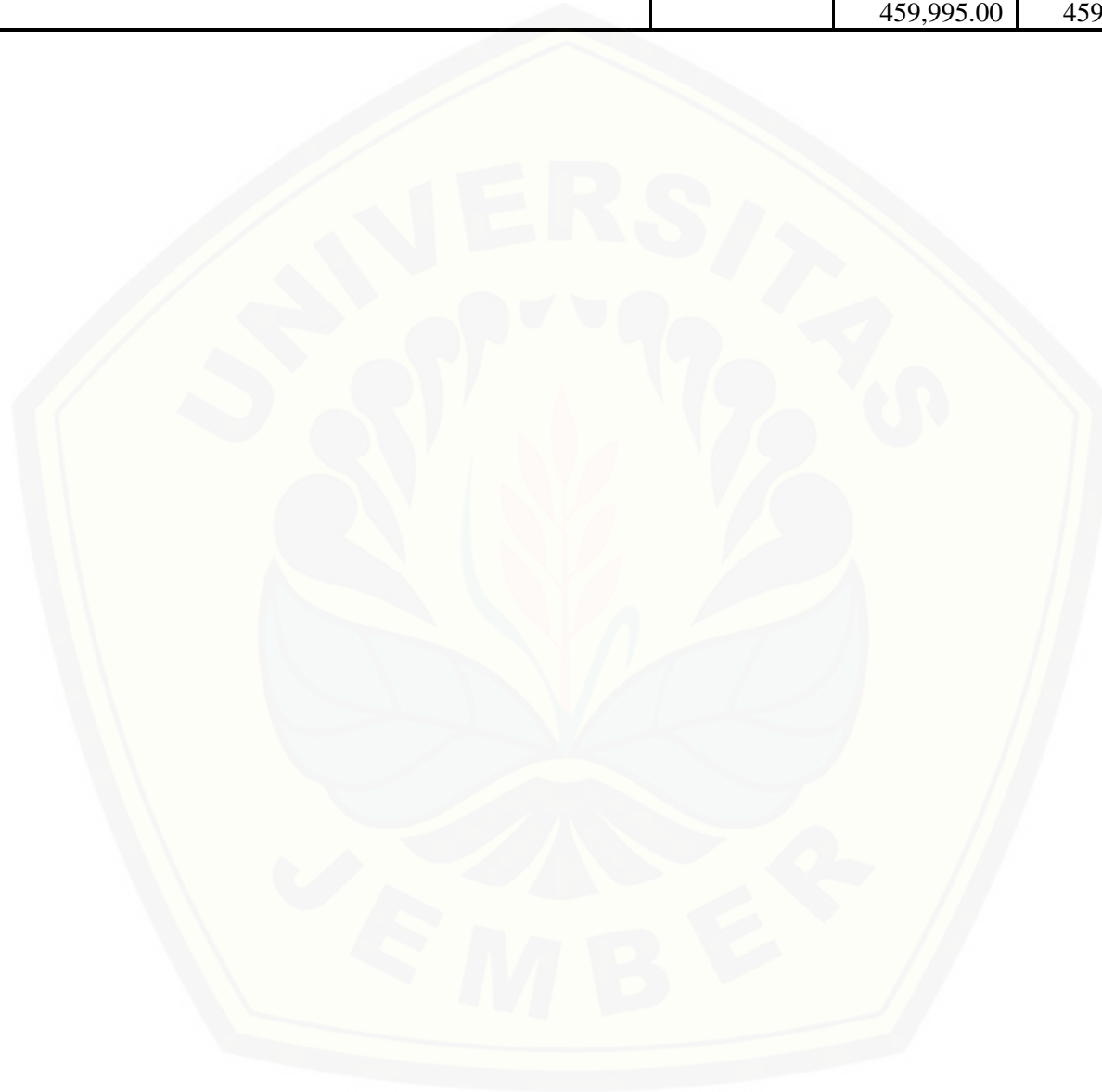

**ANALISA SATUAN PEKERJAAN
KABUPATEN JEMBER 2017**

Pekerjaan Tanah

NO.	JENIS PEKERJAAN	BAHAN	UPAH	JUMLAH	BULAT
1	2	3	4	5	6
1	Analisa SNI Dinas PU. Cipta Karya dan Tata Ruang				
	Menggali 1 m ³ tanah biasa sedalam 1 m				
	Upah				
	0.750 Oh Pekerja Rp 65,000.00		48,750.00		
	0.025 Oh Mandor Rp 80,000.00		2,000.00		
			50,750.00	50,750.00	50,700.00
2	Analisa SNI Dinas PU. Cipta Karya dan Tata Ruang				
	Menggali 1 m ³ tanah biasa sedalam 2 m				
	Upah				
	0.900 Oh Pekerja Rp 65,000.00		58,500.00		
	0.045 Oh Mandor Rp 80,000.00		3,600.00		
			62,100.00	62,100.00	62,100.00
3	Analisa SNI Dinas PU. Cipta Karya dan Tata Ruang				
	Menggali 1 m ³ tanah biasa sedalam 3 m				
	Upah				
	1.050 Oh Pekerja Rp 65,000.00		68,250.00		
	0.067 Oh Mandor Rp 80,000.00		5,360.00		
			73,610.00	73,610.00	73,600.00
	Bor Strous 1 ml			13,500.00	13,500.00
4	Analisa SNI Dinas PU. Cipta Karya dan Tata Ruang				
	Menggali 1 m ³ tanah Keras sedalam 1 m				
	Upah				
	1.000 Oh Pekerja Rp 65,000.00		65,000.00		
	0.032 Oh Mandor Rp 80,000.00		2,560.00		
			67,560.00	67,560.00	67,500.00

5	Analisa SNI Dinas PU. Cipta Karya dan Tata Ruang						
	Mengerjakan 1 m ² stripping tebing setinggi 1 m						
	Upah						
		0.050 Oh Pekerja	Rp 65,000.00		3,250.00		
		0.005 Oh Mandor	Rp 80,000.00		400.00		
					3,650.00	3,650.00	3,600.00
6	Analisa SNI Dinas PU. Cipta Karya dan Tata Ruang						
	Membuang 1 m ³ tanah sejauh 30 m						
	Upah						
		0.330 Oh Pekerja	Rp 65,000.00		21,450.00		
		0.010 Oh Mandor	Rp 80,000.00		800.00		
					22,250.00	22,250.00	22,200.00
5	Analisa SNI Dinas PU. Cipta Karya dan Tata Ruang						
	Mengurug kembali 1 m ³ galian						
	Upah						
		0.500 Pekerja	65,000.00		32,500.00		
		0.050 Mandor	80,000.00		4,000.00		
					36,500.00	36,500.00	36,500.00
6	Analisa SNI Dinas PU. Cipta Karya dan Tata Ruang						
	Mengurug 1 m ³ pasir urug						
	Bahan						
		1.200 m ³ Pasir urug	Rp 72,000.00	86,400.00			
	Upah						
		0.300 Oh Pekerja	Rp 65,000.00		19,500.00		
		0.010 Oh Mandor	Rp 80,000.00		800.00		
				86,400.00	20,300.00	106,700.00	106,700.00
9	Analisa SNI Dinas PU. Cipta Karya dan Tata Ruang						
	Memasang 1 m ² lapisan ijuk tebal 10 cm, untuk bidang resapan						
	Bahan						
		6.000 Kg Ijuk	Rp 1,500.00	9,000.00			
	Upah						

		0.150 Oh Pekerja Rp 65,000.00		9,750.00		
		0.015 Oh Mandor Rp 80,000.00		1,200.00		
			9,000.00	10,950.00	19,950.00	19,900.00
7	Analisa SNI Dinas PU. Cipta Karya dan Tata Ruang					
	Mengurug 1 m ³ sirtu padat untuk peninggian lantai bangunan					
	Bahan					
		1.200 m ³ Sirtu Rp 65,000.00	78,000.00			
	Upah					
		0.250 Oh Pekerja Rp 65,000.00		16,250.00		
		0.025 Oh Mandor Rp 80,000.00		2,000.00		
			78,000.00	18,250.00	96,250.00	96,200.00
8	Analisa SNI Dinas PU. Cipta Karya dan Tata Ruang					
	Mengurug 1 m ³ tanah dengan pemadatan					
	Bahan					
		1.200 m ³ Tanah Ur Rp 65,000.00	78,000.00			
	Upah					
		0.250 Oh Pekerja Rp 65,000.00		16,250.00		
		0.010 Oh Mandor Rp 80,000.00		800.00		
			78,000.00	17,050.00	95,050.00	95,000.00

**ANALISA SATUAN PEKERJAAN
KABUPATEN JEMBER 2017**

Pekerjaan Pondasi

NO.	JENIS PEKERJAAN	BAHAN	UPAH	JUMLAH	BULAT
1	2	3	4	5	6
1	Analisa SNI Dinas PU. Cipta Karya dan Tata Ruang				
	Memasang 1 m ³ pondasi batu belah, camp. 1 PC : 3 PP				
	Bahan				
	1.200 m ³ Batu belah 15/20 Rp 140,000.00	168,000.00			
	202.000 Kg PC Rp 2,000.00	404,000.00			
	0.485 m ³ Pasir pasang Rp 140,000.00	67,900.00			
	Upah				
	1.500 Oh Pekerja Rp 65,000.00		97,500.00		
	0.750 Oh Tukang batu Rp 70,000.00		52,500.00		
	0.075 Oh Kepala tukang Rp 75,000.00		5,625.00		
	0.075 Oh Mandor Rp 80,000.00		6,000.00		
		639,900.00	161,625.00	801,525.00	801,500.00
2	Analisa SNI Dinas PU. Cipta Karya dan Tata Ruang				
	Memasang 1 m ³ pondasi batu belah, camp. 1 PC : 4 PP				
	Bahan				
	1.200 m ³ Batu belah 15/20 cm Rp 140,000.00	168,000.00			
	163.000 Kg PC Rp 2,000.00	326,000.00			
	0.520 m ³ Pasir pasang (Pasir Kali) Rp 140,000.00	72,800.00			
	Upah				
	1.500 Oh Pekerja Rp 65,000.00		97,500.00		
	0.750 Oh Tukang batu Rp 70,000.00		52,500.00		
	0.075 Oh Kepala tukang Rp 75,000.00		5,625.00		
	0.075 Oh Mandor Rp 80,000.00		6,000.00		
		566,800.00	161,625.00	728,425.00	728,400.00

3	Analisa SNI Dinas PU. Cipta Karya dan Tata Ruang				
	Memasang 1 m ³ pondasi batu belah, camp. 1 PC : 5 PP				
	Bahan				
	1.200 m ³ Batu belah 15/20 cm	Rp 140,000.00	168,000.00		
	136.000 Kg PC	Rp 2,000.00	272,000.00		
	0.544 m ³ Pasir pasang (Pasir Kali)	Rp 140,000.00	76,160.00		
	Upah				
	1.500 Oh Pekerja	Rp 65,000.00	97,500.00		
	0.750 Oh Tukang batu	Rp 70,000.00	52,500.00		
	0.075 Oh Kepala tukang	Rp 75,000.00	5,625.00		
	0.075 Oh Mandor	Rp 80,000.00	6,000.00		
			516,160.00	161,625.00	677,785.00
					677,700.00
4	Analisa SNI Dinas PU. Cipta Karya dan Tata Ruang				
	Memasang 1 m ³ pondasi batu belah, camp. 1 PC : 6 PP				
	Bahan				
	1.200 m ³ Batu belah 15/20 cm	Rp 140,000.00	168,000.00		
	117.000 Kg PC	Rp 2,000.00	234,000.00		
	0.561 m ³ Pasir pasang (Pasir Kali)	Rp 140,000.00	78,540.00		
	Upah				
	1.500 Oh Pekerja	Rp 65,000.00	97,500.00		
	0.750 Oh Tukang batu	Rp 70,000.00	52,500.00		
	0.075 Oh Kepala tukang	Rp 75,000.00	5,625.00		
	0.075 Oh Mandor	Rp 80,000.00	6,000.00		
			480,540.00	161,625.00	642,165.00
					642,100.00
5	Analisa SNI Dinas PU. Cipta Karya dan Tata Ruang				
	Memasang 1 m ³ pondasi batu belah, camp. 1 PC : 8 PP				
	Bahan				
	1.200 m ³ Batu belah 15/20 cm	Rp 140,000.00	168,000.00		
	91.000 Kg PC	Rp 2,000.00	182,000.00		
	0.584 m ³ Pasir pasang (Pasir Kali)	Rp 140,000.00	81,760.00		

	Upah					
	1.500 Oh Pekerja	Rp	65,000.00		97,500.00	
	0.750 Oh Tukang batu	Rp	70,000.00		52,500.00	
	0.075 Oh Kepala tukang	Rp	75,000.00		5,625.00	
	0.075 Oh Mandor	Rp	80,000.00		6,000.00	
				431,760.00	161,625.00	593,385.00
6	Analisa SNI Dinas PU. Cipta Karya dan Tata Ruang					
	Memasang 1 m ³ batu belah, camp. 1 KP : 1 Sm': 2 PP					
	Bahan					
	1.200 m ³ Batu belah 15/20 cm	Rp	140,000.00	168,000.00		
	0.170 m ³ Kapur	Rp	8,000.00	1,360.00		
	0.170 m ³ Semen Merah	Rp	140,000.00	23,800.00		
	0.340 m ³ Pasir pasang (Pasir Kali)	Rp	140,000.00	47,600.00		
	Upah					
	1.500 Oh Pekerja	Rp	65,000.00		97,500.00	
	0.750 Oh Tukang batu	Rp	70,000.00		52,500.00	
	0.075 Oh Kepala tukang	Rp	75,000.00		5,625.00	
	0.075 Oh Mandor	Rp	80,000.00		6,000.00	
				240,760.00	161,625.00	402,385.00
6	Analisa SNI Dinas PU. Cipta Karya dan Tata Ruang					
	Memasang 1 m ³ batu belah, camp. 1PC : 3KP : 10PP					
	Bahan					
	1.200 m ³ Batu belah 15/20 cm	Rp	140,000.00	168,000.00		
	61.000 Kg PC	Rp	2,000.00	122,000.00		
	0.147 m ³ Kapur	Rp	8,000.00	1,176.00		
	0.492 m ³ Pasir pasang (Pasir Kali)	Rp	140,000.00	68,880.00		
	Upah					
	1.500 Oh Pekerja	Rp	65,000.00		97,500.00	
	0.750 Oh Tukang batu	Rp	70,000.00		52,500.00	
	0.075 Oh Kepala tukang	Rp	75,000.00		5,625.00	

	0.075 Oh Mandor	Rp 80,000.00		6,000.00		
			360,056.00	161,625.00	521,681.00	521,600.00
8	Analisa SNI Dinas PU. Cipta Karya dan Tata Ruang					
	Memasang 1 m ³ batu belah, camp. 1/2PC : 1KP : 4PP					
	Bahan					
	1.200 m ³ Batu belah 15/20 cm	Rp 140,000.00	168,000.00			
	41.000 Kg PC	Rp 2,000.00	82,000.00			
	0.131 m ³ Kapur	Rp 8,000.00	1,048.00			
	0.523 m ³ Pasir pasang (Pasir Kali)	Rp 140,000.00	73,220.00			
	Upah					
	1.500 Oh Pekerja	Rp 65,000.00		97,500.00		
	0.750 Oh Tukang batu	Rp 70,000.00		52,500.00		
	0.075 Oh Kepala tukang	Rp 75,000.00		5,625.00		
	0.075 Oh Mandor	Rp 80,000.00		6,000.00		
			324,268.00	161,625.00	485,893.00	485,800.00
7	Analisa SNI Dinas PU. Cipta Karya dan Tata Ruang					
	Memasang 1 m ³ batu kosong (anstamping)					
	Bahan					
	1.200 m ³ Batu belah 15/20 cm	Rp 140,000.00	168,000.00			
	0.432 m ³ Pasir Urug	Rp 72,000.00	31,104.00			
	Upah					
	0.780 Oh Pekerja	Rp 65,000.00		50,700.00		
	0.390 Oh Tukang batu	Rp 70,000.00		27,300.00		
	0.039 Oh Kepala tukang	Rp 75,000.00		2,925.00		
	0.039 Oh Mandor	Rp 80,000.00		3,120.00		
			199,104.00	84,045.00	283,149.00	283,100.00
10	Analisa SNI Dinas PU. Cipta Karya dan Tata Ruang					
	Memasang 1 m ³ pondasi siklop,80% beton campuran 1PC : 2PS : 3KR					
	Bahan					
	0.480 m ³ Batu belah 15/20 cm	Rp 140,000.00	67,200.00			

	194.000 Kg PC	Rp 2,000.00	388,000.00			
	0.312 m ³ Pasir beton (Pasir Kali)	Rp 140,000.00	43,680.00			
	0.468 m ³ Kerikil	Rp 130,000.00	60,840.00			
	126.000 Kg Besi Beton	Rp 8,000.00	1,008,000.00			
	1.800 Kg Kawat beton	Rp 15,000.00	27,000.00			
	Upah					
	3.400 Oh Pekerja	Rp 65,000.00		221,000.00		
	0.850 Oh Tukang batu	Rp 70,000.00		59,500.00		
	0.085 Oh Kepala tukang	Rp 75,000.00		6,375.00		
	0.170 Oh Mandor	Rp 80,000.00		13,600.00		
			1,594,720.00	300,475.00	1,895,195.00	1,895,100.00
8	Analisa SNI Dinas PU. Cipta Karya dan Tata Ruang					
	Memasang 1 m ³ pondasi sumuran diameter 100 cm					
	Bahan					
	0.450 m ³ Batu belah 15/20 cm	Rp 140,000.00	63,000.00			
	194.000 Kg PC	Rp 2,000.00	388,000.00			
	0.468 m ³ Kerikil	Rp 130,000.00	60,840.00			
	0.312 m ³ Pasir beton (Pasir Kali)	Rp 140,000.00	43,680.00			
	Upah					
	2.400 Oh Pekerja	Rp 65,000.00		156,000.00		
	0.800 Oh Tukang batu	Rp 70,000.00		56,000.00		
	0.080 Oh Kepala tukang	Rp 75,000.00		6,000.00		
	0.119 Oh Mandor	Rp 80,000.00		9,520.00		
			555,520.00	227,520.00	783,040.00	783,000.00

ANALISA SATUAN PEKERJAAN KABUPATEN JEMBER 2017

Pekerjaan Dinding

NO.	JENIS PEKERJAAN	BAHAN	UPAH	JUMLAH	BULAT
1	2	3	4	5	6
1	Analisa SNI DPU Cipta Karya dan Tata Ruang				
	Memasang 1 m ² dinding bata merah Uk. (5x11x22) cm tb. 1 bata , camp. 1PC : 3 PP				
	Bahan				
	140.00 Bh Bh Batu merah	Rp 400.00		56,000.00	
	32.950 Kg PC	Rp 2,000.00		65,900.00	
	0.091 m ³ Pasir pasang (Pasir Kali)	Rp 140,000.00		12,740.00	
	Upah				
	0.600 Oh Pekerja	Rp 65,000.00		39,000.00	
	0.200 Oh Tukang batu	Rp 70,000.00		14,000.00	
	0.020 Oh Kepala tukang	Rp 75,000.00		1,500.00	
	0.030 Oh Mandor	Rp 80,000.00		2,400.00	
				134,640.00	56,900.00
				191,540.00	191,500.00
2	Analisa SNI DPU Cipta Karya dan Tata Ruang				
	Memasang 1 m ² dinding bata merah Uk. (5x11x22) cm tb. 1 bata , camp. 1PC : 6 PP				
	Bahan				
	140.00 Bh Batu merah	Rp 400.00		56,000.00	
	18.500 Kg PC	Rp 2,000.00		37,000.00	
	0.122 m ³ Pasir pasang (Pasir Kali)	Rp 140,000.00		17,080.00	
	Upah				
	0.600 Oh Pekerja	Rp 65,000.00		39,000.00	
	0.200 Oh Tukang batu	Rp 70,000.00		14,000.00	
	0.020 Oh Kepala tukang	Rp 75,000.00		1,500.00	
	0.030 Oh Mandor	Rp 80,000.00		2,400.00	
				110,080.00	56,900.00
				166,980.00	166,900.00
3	Analisa SNI DPU Cipta Karya dan Tata Ruang				

	Memasang 1 m ² dinding bata merah Uk. (5x11x22) cm tb. 1 bata , camp. 1PC : 3 KP : 10 PP							
	Bahan							
	140.00 Bh	Batu merah	Rp	400.00	56,000.00			
	10.080 Kg	PC	Rp	2,000.00	20,160.00			
	0.093 m ³	Pasir pasang (Pasir Kali)	Rp	140,000.00	12,950.00			
	0.028 m ³	Kapur	Rp	8,000.00	220.00			
	Upah							
	0.600 Oh	Pekerja	Rp	65,000.00		39,000.00		
	0.200 Oh	Tukang batu	Rp	70,000.00		14,000.00		
	0.020 Oh	Kepala tukang	Rp	75,000.00		1,500.00		
	0.030 Oh	Mandor	Rp	80,000.00		2,400.00		
					89,330.00	56,900.00	146,230.00	146,200.00
4	Analisa SNI DPU Cipta Karya dan Tata Ruang							
	Memasang 1 m ² dinding bata merah Uk. (5x11x22) cm tb. 1/2 bata , camp. 1PC : 3 PP							
	Bahan							
	70.00 Bh	Batu merah	Rp	400.00	28,000.00			
	14.370 Kg	PC	Rp	2,000.00	28,740.00			
	0.040 m ³	Pasir pasang (Pasir Kali)	Rp	140,000.00	5,600.00			
	Upah							
	0.300 Oh	Pekerja	Rp	65,000.00		19,500.00		
	0.100 Oh	Tukang batu	Rp	70,000.00		7,000.00		
	0.010 Oh	Kepala tukang	Rp	75,000.00		750.00		
	0.015 Oh	Mandor	Rp	80,000.00		1,200.00		
					62,340.00	28,450.00	90,790.00	90,700.00
5	Analisa SNI DPU Cipta Karya dan Tata Ruang							
	Memasang 1 m ² dinding bata merah Uk. (5x11x22) cm tb. 1/2 bata , camp. 1PC : 5 PP							
	Bahan							
	70.00 Bh	Batu merah	Rp	400.00	28,000.00			
	9.680 Kg	PC	Rp	2,000.00	19,360.00			
	0.045 m ³	Pasir pasang (Pasir Kali)	Rp	140,000.00	6,300.00			

	Upah							
	0.300 Oh	Pekerja	Rp	65,000.00		19,500.00		
	0.100 Oh	Tukang batu	Rp	70,000.00		7,000.00		
	0.010 Oh	Kepala tukang	Rp	75,000.00		750.00		
	0.015 Oh	Mandor	Rp	80,000.00		1,200.00		
					53,660.00	28,450.00	82,110.00	82,100.00
6	Analisa SNI DPU Cipta Karya dan Tata Ruang							
	Memasang 1 m ² dinding bata merah Uk. (5x11x22) cm tb. 1/2 bata , camp. 1PC : 6 PP							
	Bahan							
	70.00 Bh	Batu merah	Rp	400.00	28,000.00			
	8.320 Kg	PC	Rp	2,000.00	16,640.00			
	0.049 m ³	Pasir pasang (Pasir Kali)	Rp	140,000.00	6,860.00			
	Upah							
	0.300 Oh	Pekerja	Rp	65,000.00		19,500.00		
	0.100 Oh	Tukang batu	Rp	70,000.00		7,000.00		
	0.010 Oh	Kepala tukang	Rp	75,000.00		750.00		
	0.015 Oh	Mandor	Rp	80,000.00		1,200.00		
					51,500.00	28,450.00	79,950.00	79,900.00
7	Analisa SNI DPU Cipta Karya dan Tata Ruang							
	Memasang 1 m ² dinding bata merah Uk. (5x11x22) cm tb. 1/2 bata , camp. 1PC : 8 PP							
	Bahan							
	70.00 Bh	Batu merah	Rp	400.00	28,000.00			
	6.500 Kg	PC	Rp	2,000.00	13,000.00			
	0.050 m ³	Pasir pasang (Pasir Kali)	Rp	140,000.00	7,000.00			
	Upah							
	0.300 Oh	Pekerja	Rp	65,000.00		19,500.00		
	0.100 Oh	Tukang batu	Rp	70,000.00		7,000.00		
	0.010 Oh	Kepala tukang	Rp	75,000.00		750.00		
	0.015 Oh	Mandor	Rp	80,000.00		1,200.00		
					48,000.00	28,450.00	76,450.00	76,400.00
8	Analisa SNI DPU Cipta Karya dan Tata Ruang							

	Memasang 1 m ² dinding bata merah Uk. (5x11x22) cm tb. 1/2 bata , camp. 1PC : 3 KP : 10 PP							
	Bahan							
	70.00 Bh	Batu merah	Rp	400.00	28,000.00			
	4.500 Kg	PC	Rp	2,000.00	9,000.00			
	0.050 m ³	Pasir pasang (Pasir Kali)	Rp	140,000.00	7,000.00			
	0.015 m ³	Kapur Pasang	Rp	8,000.00	120.00			
	Upah							
	0.300 Oh	Pekerja	Rp	65,000.00		19,500.00		
	0.100 Oh	Tukang batu	Rp	70,000.00		7,000.00		
	0.010 Oh	Kepala tukang	Rp	75,000.00		750.00		
	0.015 Oh	Mandor	Rp	75,900.00		1,138.50		
					44,120.00	28,388.50	72,508.50	72,500.00
9	Analisa SNI DPU Cipta Karya dan Tata Ruang							
	Memasang 1 m ² dinding terawang (ROSTER) Uk. (12x11x24) cm, camp. 1PC : 4 PP							
	Bahan							
	30.00 Bh	Terawang roster	Rp	5,000.00	150,000.00			
	11.000 Kg	PC	Rp	2,000.00	22,000.00			
	0.035 m ³	Pasir pasang (Pasir Kali)	Rp	140,000.00	4,900.00			
	Upah							
	0.300 Oh	Pekerja	Rp	65,000.00		19,500.00		
	0.100 Oh	Tukang batu	Rp	70,000.00		7,000.00		
	0.010 Oh	Kepala tukang	Rp	75,000.00		750.00		
	0.015 Oh	Mandor	Rp	80,000.00		1,200.00		
					176,900.00	28,450.00	205,350.00	205,300.00
10	Analisa SNI DPU Cipta Karya dan Tata Ruang							
	Memasang 1 m ² Batu Candi Uk. (10x20x1.5) cm, camp. 1PC : 4 PP							
	Bahan							
	12.50 Bh	Batu Candi	Rp	12,000.00	150,000.00			
	6.480 Kg	PC	Rp	2,000.00	12,960.00			
	0.021 m ³	Pasir pasang (Pasir Kali)	Rp	180,000.00	3,780.00			

	Upah						
	0.400 Oh	Pekerja	Rp	65,000.00		26,000.00	
	0.200 Oh	Tukang batu	Rp	70,000.00		14,000.00	
	0.020 Oh	Kepala tukang	Rp	75,000.00		1,500.00	
	0.020 Oh	Mandor	Rp	80,000.00		1,600.00	
					166,740.00	43,100.00	209,840.00
							209,800.00

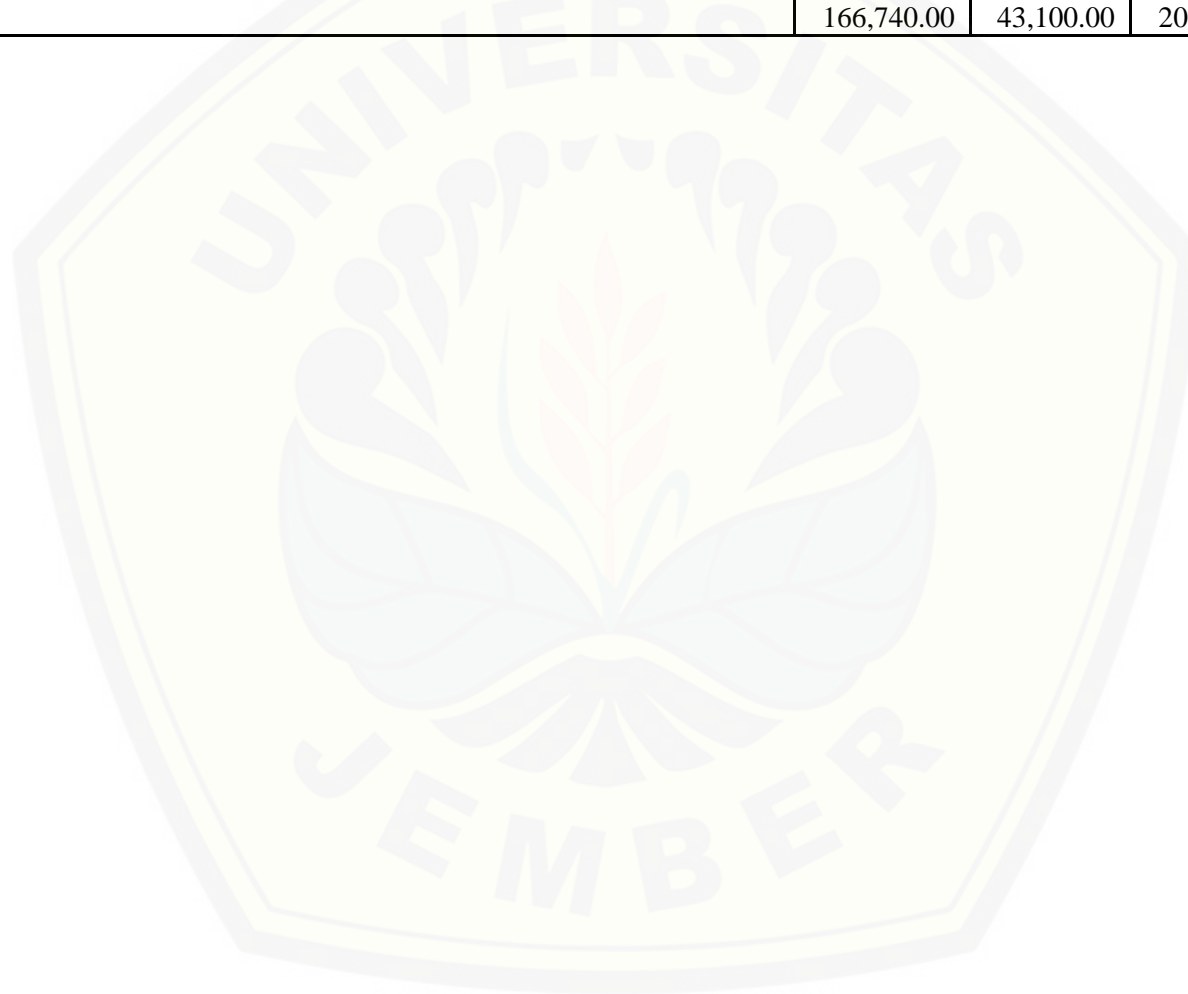

ANALISA SATUAN PEKERJAAN KABUPATEN JEMBER 2017

Pekerjaan Plesteran

NO.	JENIS PEKERJAAN	BAHAN	UPAH	JUMLAH	BULAT
1	2	3	4	5	6
1	Analisa SNI DPU Cipta Karya dan Tata Ruang				
	Memasang 1 m ² Plesteran camp. 1 Pc : 3 Ps tebal 15mm				
	Bahan				
	7.776 Kg PC Rp 2,000.00	15,552.00			
	0.023 m ³ Pasir pasang (Pasir Kali) Rp 140,000.00	3,220.00			
	Upah				
	0.300 Oh Pekerja Rp 65,000.00		19,500.00		
	0.150 Oh Tukang batu Rp 70,000.00		10,500.00		
	0.015 Oh Kepala tukang Rp 75,000.00		1,125.00		
	0.015 Oh Mandor Rp 80,000.00		1,200.00		
		18,772.00	32,325.00	51,097.00	51,000.00
2	Analisa SNI DPU Cipta Karya dan Tata Ruang				
	Memasang 1 m ² Plesteran camp. 1 Pc : 5 Ps tebal 15mm				
	Bahan				
	5.184 Kg PC Rp 2,000.00	10,368.00			
	0.026 m ³ Pasir pasang (Pasir Kali) Rp 140,000.00	3,640.00			
	Upah				
	0.300 Oh Pekerja Rp 65,000.00		19,500.00		
	0.150 Oh Tukang batu Rp 70,000.00		10,500.00		
	0.015 Oh Kepala tukang Rp 75,000.00		1,125.00		
	0.015 Oh Mandor Rp 80,000.00		1,200.00		
		14,008.00	32,325.00	46,333.00	46,300.00
3	Analisa SNI DPU Cipta Karya dan Tata Ruang				
	Memasang 1 m ² Plesteran camp. 1 Pc : 6 Ps tebal 15mm				

	Bahan							
	4.416 Kg	PC	Rp	2,000.00	8,832.00			
	0.027 m ³	Pasir pasang (Pasir Kali)	Rp	140,000.00	3,780.00			
	Upah							
	0.300 Oh	Pekerja	Rp	65,000.00		19,500.00		
	0.150 Oh	Tukang batu	Rp	70,000.00		10,500.00		
	0.015 Oh	Kepala tukang	Rp	75,000.00		1,125.00		
	0.015 Oh	Mandor	Rp	80,000.00		1,200.00		
					12,612.00	32,325.00	44,937.00	44,900.00
4	Analisa SNI DPU Cipta Karya dan Tata Ruang							
	Memasang 1 m ² Plesteran camp. 1 Pc : 8 Ps tebal 15mm							
	Bahan							
	3.456 Kg	PC	Rp	2,000.00	6,912.00			
	0.029 m ³	Pasir pasang (Pasir Kali)	Rp	140,000.00	4,060.00			
	Upah							
	0.300 Oh	Pekerja	Rp	65,000.00		19,500.00		
	0.150 Oh	Tukang batu	Rp	70,000.00		10,500.00		
	0.015 Oh	Kepala tukang	Rp	75,000.00		1,125.00		
	0.015 Oh	Mandor	Rp	80,000.00		1,200.00		
					10,972.00	32,325.00	43,297.00	43,200.00
5	Analisa SNI DPU Cipta Karya dan Tata Ruang							
	Memasang 1 m ² Plesteran camp. 1 Pc : ½ KP : 3 Ps tebal 15mm							
	Bahan							
	5.760 Kg	PC	Rp	2,000.00	11,520.00			
	0.003 m ³	Kapur Pasang	Rp	8,000.00	24.00			
	0.013 m ³	Pasir pasang (Pasir Kali)	Rp	140,000.00	1,820.00			
	Upah							
	0.360 Oh	Pekerja	Rp	65,000.00		23,400.00		
	0.120 Oh	Tukang batu	Rp	70,000.00		8,400.00		
	0.012 Oh	Kepala tukang	Rp	75,000.00		900.00		

	0.018 Oh	Mandor	Rp	80,000.00		1,440.00		
					13,364.00	34,140.00	47,504.00	47,500.00
5	Analisa SNI DPU Cipta Karya dan Tata Ruang							
	Memasang 1 m ² Plesteran camp. 1 Pc : 2 KP : 8 Ps tebal 15mm							
	Bahan							
	3.000 Kg	PC	Rp	2,000.00	6,000.00			
	0.005 m ³	Kapur Pasang	Rp	8,000.00	40.00			
	0.020 m ³	Pasir pasang (Pasir Kali)	Rp	140,000.00	2,800.00			
	Upah							
	0.360 Oh	Pekerja	Rp	65,000.00		23,400.00		
	0.120 Oh	Tukang batu	Rp	70,000.00		8,400.00		
	0.012 Oh	Kepala tukang	Rp	75,000.00		900.00		
	0.018 Oh	Mandor	Rp	80,000.00		1,440.00		
					8,840.00	34,140.00	42,980.00	42,900.00
7	Analisa SNI DPU Cipta Karya dan Tata Ruang							
	Memasang 1 m ² Plesteran camp. 1 PC : 3 Ps tebal 20mm							
	Bahan							
	10.368 Kg	PC	Rp	2,000.00	20,736.00			
	0.031 m ³	Pasir pasang (Pasir Kali)	Rp	140,000.00	4,340.00			
	Upah							
	0.260 Oh	Pekerja	Rp	65,000.00		16,900.00		
	0.200 Oh	Tukang batu	Rp	70,000.00		14,000.00		
	0.020 Oh	Kepala tukang	Rp	75,000.00		1,500.00		
	0.022 Oh	Mandor	Rp	80,000.00		1,760.00		
					25,076.00	34,160.00	59,236.00	59,200.00
8	Analisa SNI DPU Cipta Karya dan Tata Ruang							
	Memasang 1 m ² Plesteran camp. 1 PC : 5 Ps tebal 20mm							
	Bahan							
	6.912 Kg	PC	Rp	2,000.00	13,824.00			
	0.035 m ³	Pasir pasang (Pasir Kali)	Rp	140,000.00	4,900.00			

	Upah							
	0.400 Oh	Pekerja	Rp	65,000.00		26,000.00		
	0.200 Oh	Tukang batu	Rp	70,000.00		14,000.00		
	0.020 Oh	Kepala tukang	Rp	75,000.00		1,500.00		
	0.022 Oh	Mandor	Rp	80,000.00		1,760.00		
					18,724.00	43,260.00	61,984.00	61,900.00
6	Analisa SNI DPU Cipta Karya dan Tata Ruang							
	Memasang 1 m ² Berapen camp. 1 PC : 5 Ps tebal 15mm							
	Bahan							
	5.184 Kg	PC	Rp	2,000.00	10,368.00			
	0.026 m ³	Pasir pasang (Pasir Kali)	Rp	140,000.00	3,640.00			
	Upah							
	0.150 Oh	Pekerja	Rp	65,000.00		9,750.00		
	0.075 Oh	Tukang batu	Rp	70,000.00		5,250.00		
	0.008 Oh	Kepala tukang	Rp	75,000.00		600.00		
	0.008 Oh	Mandor	Rp	80,000.00		640.00		
					14,008.00	16,240.00	30,248.00	30,200.00
10	Analisa SNI DPU Cipta Karya dan Tata Ruang							
	Memasang 1 m ² finishing siar pas. dinding bata merah (=20m')							
	Bahan							
	3.108 Kg	PC	Rp	2,000.00	6,216.00			
	Upah							
	0.150 Oh	Pekerja	Rp	65,000.00		9,750.00		
	0.075 Oh	Tukang batu	Rp	70,000.00		5,250.00		
	0.008 Oh	Kepala tukang	Rp	75,000.00		600.00		
	0.008 Oh	Mandor	Rp	80,000.00		640.00		
					6,216.00	16,240.00	22,456.00	22,400.00
11	Analisa SNI DPU Cipta Karya dan Tata Ruang							
	Memasang 1 m ² finishing siar pas. batu kali adukan 1 PC : 2 Ps.							
	Bahan							
	6.340 Kg	PC	Rp	2,000.00	12,680.00			

	0.012 m ³	Pasir pasang (Pasir Kali)	Rp	140,000.00	1,680.00			
	Upah							
	0.300 Oh	Pekerja	Rp	65,000.00		19,500.00		
	0.150 Oh	Tukang batu	Rp	70,000.00		10,500.00		
	0.015 Oh	Kepala tukang	Rp	75,000.00		1,125.00		
	0.015 Oh	Mandor	Rp	80,000.00		1,200.00		
					14,360.00	32,325.00	46,685.00	46,600.00
7	Analisa SNI DPU Cipta Karya dan Tata Ruang							
	Memasang 1 m ² Acian							
	Bahan							
	3.250 Kg	PC	Rp	2,000.00	6,500.00			
	Upah							
	0.200 Oh	Pekerja	Rp	65,000.00		13,000.00		
	0.100 Oh	Tukang batu	Rp	70,000.00		7,000.00		
	0.010 Oh	Kepala tukang	Rp	75,000.00		750.00		
	0.010 Oh	Mandor	Rp	80,000.00		800.00		
					6,500.00	21,550.00	28,050.00	28,000.00
8	Analisa SNI DPU Cipta Karya dan Tata Ruang							
	Memasang 1 m' Benangan 1 PC : 2 PP							
	Bahan							
	0.344 Kg	PC	Rp	2,000.00	688.00			
	0.001 m ³	Pasir pasang (Pasir Kali)	Rp	140,000.00	140.00			
	Upah							
	0.133 Oh	Pekerja	Rp	65,000.00		8,664.50		
	0.067 Oh	Tukang batu	Rp	70,000.00		4,662.00		
	0.007 Oh	Kepala tukang	Rp	75,000.00		495.00		
	0.007 Oh	Mandor	Rp	80,000.00		528.00		
					828.00	14,349.50	15,177.50	15,100.00

ANALISA SATUAN PEKERJAAN
KABUPATEN JEMBER 2017

Pekerjaan Kayu

NO.	JENIS PEKERJAAN	BAHAN	UPAH	JUMLAH	BULAT
1	2	3	4	5	6
1	Analisa SNI DPU Cipta Karya dan Tata Ruang				
	Membuat dan Memasang 1 m ³ Kusen Pintu dan Jusen Jendela, Kayu Kl. I				
	Bahan				
	1.100 m ³ Balok Kayu kelas I	Rp 9,000,000.00	9,900,000.00		
	1.250 Kg Paku 10 cm	Rp 16,000.00	20,000.00		
	1.000 Kg Lem Kayu	Rp 11,500.00	11,500.00		
	Upah				
	7.000 Oh Pekerja	Rp 65,000.00	455,000.00		
	21.000 Oh Tukang kayu	Rp 70,000.00	1,470,000.00		
	2.100 Oh Kepala tukang	Rp 75,000.00	157,500.00		
	0.350 Oh Mandor	Rp 80,000.00	28,000.00		
			9,931,500.00	2,110,500.00	12,042,000.00
2	Analisa SNI DPU Cipta Karya dan Tata Ruang				
	Membuat dan Memasang 1 m ³ Kusen Pintu dan Jusen Jendela, Kayu Kl. II atau Kl. III				
	Bahan				
	1.200 m ³ Balok Kayu Kelas II	Rp 5,000,000.00	6,000,000.00		
	0.999 m ³ Balok Kayu Kelas III	Rp 3,000,000.00	2,997,000.00		
	1.250 Kg Paku 10 cm	Rp 16,000.00	20,000.00		
	1.000 Kg Lem Kayu	Rp 11,500.00	11,500.00		
	Upah				
	6.000 Oh Pekerja	Rp 65,000.00	390,000.00		
	18.000 Oh Tukang kayu	Rp 70,000.00	1,260,000.00		
	1.800 Oh Kepala tukang	Rp 75,000.00	135,000.00		
	0.300 Oh Mandor	Rp 80,000.00	24,000.00		

	Membuat & Memasang Kusén Pintu dan Jusén Jendela Kayu Kl. II		6,031,500.00	1,809,000.00	7,840,500.00	7,840,500.00
	Membuat & Memasang Kusén Pintu dan Jusén Jendela Kayu Kl. III		3,028,500.00	1,809,000.00	4,837,500.00	4,837,500.00
3	Analisa SNI DPU Cipta Karya dan Tata Ruang					
	Membuat dan Memasang 1 m ² Pintu klamp standar, Kayu Kl. II					
	Bahan					
	0.040 m ³ Papan kayu kelas II	Rp	6,000,000.00	240,000.00		
	0.050 Kg Paku 5cm - 7cm	Rp	16,000.00	800.00		
	Upah					
	0.350 Oh Pekerja	Rp	65,000.00	22,750.00		
	1.050 Oh Tukang kayu	Rp	70,000.00	73,500.00		
	0.105 Oh Kepala tukang	Rp	75,000.00	7,875.00		
	0.018 Oh Mandor	Rp	80,000.00	1,440.00		
			240,800.00	105,565.00	346,365.00	346,300.00
4	Analisa SNI DPU Cipta Karya dan Tata Ruang					
	Membuat dan Memasang 1 m ² Pintu klamp Sederhana, Kayu Kl. III untuk gudang sementara					
	Bahan					
	0.040 m ³ Papan kayu kelas III	Rp	3,500,000.00	140,000.00		
	0.050 Kg Paku 5cm - 7cm	Rp	16,000.00	800.00		
	Upah					
	0.350 Oh Pekerja	Rp	65,000.00	22,750.00		
	1.050 Oh Tukang kayu	Rp	70,000.00	73,500.00		
	0.105 Oh Kepala tukang	Rp	75,000.00	7,875.00		
	0.018 Oh Mandor	Rp	80,000.00	1,440.00		
			140,800.00	105,565.00	246,365.00	246,300.00
5	Analisa SNI DPU Cipta Karya dan Tata Ruang					
	Membuat dan Memasang 1 m ² Daun Pintu Panel, Kayu Kl. I atau II					
	Bahan					
	0.040 m ³ Papan kayu kelas I	Rp	10,000,000.00	400,000.00		
	0.040 m ³ Papan kayu kelas II	Rp	5,000,000.00	200,000.00		
	0.500 Kg Lem kayu	Rp	11,500.00	5,750.00		

	Upah					
	1.000 Oh Pekerja	Rp	65,000.00		65,000.00	
	3.000 Oh Tukang kayu	Rp	70,000.00		210,000.00	
	0.300 Oh Kepala tukang	Rp	75,000.00		22,500.00	
	0.050 Oh Mandor	Rp	80,000.00		4,000.00	
	Membuat dan Memasang Daun Pintu Panel Kayu Kl. I		405,750.00		301,500.00	707,250.00
	Membuat dan Memasang Daun Pintu Panel Kayu Kl. II		205,750.00		301,500.00	507,250.00
6	Analisa SNI DPU Cipta Karya dan Tata Ruang					
	Membuat dan Memasang 1 m ² Pintu dan Jendela Kaca,Kayu Kl. I atau II					
	Bahan					
	0.024 m ³ Papan kayu kelas I	Rp	10,000,000.00	240,000.00		
	0.024 m ³ Papan kayu kelas II	Rp	5,000,000.00	120,000.00		
	0.300 Kg Lem kayu	Rp	11,500.00	3,450.00		
	Upah					
	0.800 Oh Pekerja	Rp	65,000.00		52,000.00	
	2.400 Oh Tukang kayu	Rp	70,000.00		168,000.00	
	0.240 Oh Kepala tukang	Rp	75,000.00		18,000.00	
	0.040 Oh Mandor	Rp	80,000.00		3,200.00	
	Membuat dan Memasang Daun Pintu & Jendela Kaca Kayu Kl. I		243,450.00		241,200.00	484,650.00
	Membuat dan Memasang Daun Pintu & Jendela Kaca Kayu Kl. II		123,450.00		241,200.00	364,650.00
7	Analisa SNI DPU Cipta Karya dan Tata Ruang					
	Membuat dan Memasang 1 m ² Pintu dan Jendela Jalusi,Kayu Kl. I atau II					
	Bahan					
	0.064 m ³ Papan kayu kelas I	Rp	10,000,000.00	640,000.00		
	0.064 m ³ Papan kayu kelas II	Rp	5,000,000.00	320,000.00		
	0.500 Kg Lem kayu	Rp	11,500.00	5,750.00		
	Upah					
	1.000 Oh Pekerja	Rp	65,000.00		65,000.00	
	3.000 Oh Tukang kayu	Rp	70,000.00		210,000.00	
	0.300 Oh Kepala tukang	Rp	75,000.00		22,500.00	

	0.050 Oh Mandor	Rp	80,000.00		4,000.00		
	Membuat dan Memasang Daun Pintu & Jendela Jalusi Kayu Kl. I			645,750.00	301,500.00	947,250.00	947,200.00
	Membuat dan Memasang Daun Pintu & Jendela Jalusi Kayu Kl. II			325,750.00	301,500.00	627,250.00	627,200.00
8	Analisa SNI DPU Cipta Karya dan Tata Ruang						
	Membuat 1 m ² Daun Pintu Lapis (plywood) rangkap, rangka tertutup kayu Kl. I (lebar sampai 90cm)						
	Bahan						
	0.025 m ³ Papan kayu Kelas I	Rp	10,000,000.00	250,000.00			
	0.030 Kg Paku 1 - 2.5 cm	Rp	16,000.00	480.00			
	0.500 Kg Lem kayu	Rp	11,500.00	5,750.00			
	1.000 Lbr Plywood tebal 4mm (90x220)	Rp	85,000.00	85,000.00			
	Upah						
	0.700 Oh Pekerja	Rp	65,000.00		45,500.00		
	2.100 Oh Tukang kayu	Rp	70,000.00		147,000.00		
	0.210 Oh Kepala tukang	Rp	75,000.00		15,750.00		
	0.035 Oh Mandor	Rp	80,000.00		2,800.00		
				341,230.00	211,050.00	552,280.00	552,200.00
9	Analisa SNI DPU Cipta Karya dan Tata Ruang						
	Membuat 1 m ² Pintu plywood rangkap, rangka expose kayu Kl. I atau II						
	Bahan						
	0.0256 m ³ Papan kayu kelas I	Rp	10,000,000.00	256,000.00			
	0.0256 m ³ Papan kayu kelas II	Rp	5,000,000.00	128,000.00			
	0.030 Kg Paku 1 - 2.5 cm	Rp	16,000.00	480.00			
	0.500 Kg Lem kayu	Rp	11,500.00	5,750.00			
	1.000 Lbr Plywood tebal 4mm (90x220)	Rp	85,000.00	85,000.00			
	Upah						
	0.800 Oh Pekerja	Rp	65,000.00		52,000.00		
	2.400 Oh Tukang kayu	Rp	70,000.00		168,000.00		
	0.240 Oh Kepala tukang	Rp	75,000.00		18,000.00		
	0.040 Oh Mandor	Rp	80,000.00		3,200.00		
	Membuat Pintu Plywood rangkap rangka expose kayu kl. I			347,230.00	241,200.00	588,430.00	588,400.00
	Membuat Pintu Plywood rangkap rangka expose kayu kl. II			219,230.00	241,200.00	460,430.00	460,400.00

10	Analisa SNI DPU Cipta Karya dan Tata Ruang					
	Membuat 1 m ² jalusi kusen, kayu Kl. I atau II					
	Bahan					
	0.0600 m ³ Papan kayu kelas I	Rp 10,000,000.00	600,000.00			
	0.0600 m ³ Papan kayu kelas II	Rp 5,000,000.00	300,000.00			
	0.150 Kg Paku 1 - 2.5 cm	Rp 16,000.00	2,400.00			
	Upah					
	0.670 Oh Pekerja	Rp 65,000.00	43,550.00			
	2.000 Oh Tukang kayu	Rp 70,000.00	140,000.00			
	0.200 Oh Kepala tukang	Rp 75,000.00	15,000.00			
	0.335 Oh Mandor	Rp 80,000.00	26,800.00			
	Membuat jalusi kusen kayu kl. I		602,400.00	225,350.00	827,750.00	827,700.00
	Membuat jalusi kusen kayu kl. II		302,400.00	225,350.00	527,750.00	527,700.00
11	Analisa SNI DPU Cipta Karya dan Tata Ruang					
	Membuat 1 m ² taekwood rangkap, rangka expose kayu Kl. I					
	Bahan					
	0.0250 m ³ Papan kayu kelas I	Rp 10,000,000.00	250,000.00			
	0.030 Kg Paku 1 - 2.5 cm	Rp 16,000.00	480.00			
	0.300 Kg Lem kayu	Rp 11,500.00	3,450.00			
	1.000 Lbr <i>Teakwood</i> tebal 4mm (90x22)	Rp 82,000.00	82,000.00			
	Upah					
	0.800 Oh Pekerja	Rp 65,000.00	52,000.00			
	2.400 Oh Tukang kayu	Rp 70,000.00	168,000.00			
	0.240 Oh Kepala tukang	Rp 75,000.00	18,000.00			
	0.040 Oh Mandor	Rp 80,000.00	3,200.00			
			335,930.00	241,200.00	577,130.00	577,100.00
12	Analisa SNI DPU Cipta Karya dan Tata Ruang					
	Memasang 1 m ³ Konstruksi Kuda kuda Konvensional, kayu klas I, II, dan III bentang 6 meter					
	Bahan					
	1.100 m ³ Balok Kayu Kelas I	Rp 9,000,000.00	9,900,000.00			

	1.100 m ³ Balok Kayu Kelas II	Rp	5,000,000.00	5,500,000.00			
	0.890 m ³ Balok Kayu Kelas III	Rp	3,000,000.00	2,670,000.00			
	15.000 Kg Besi strip tb = 5 mm /kawel	Rp	15,000.00	225,000.00			
	5.600 Kg Paku 12 cm	Rp	16,000.00	89,600.00			
	Upah						
	4.000 Oh Pekerja	Rp	65,000.00		260,000.00		
	12.000 Oh Tukang kayu	Rp	70,000.00		840,000.00		
	1.200 Oh Kepala Tukang	Rp	75,000.00		90,000.00		
	0.200 Oh Mandor	Rp	80,000.00		16,000.00		
	- Memasang 1 m ³ Kuda kuda Kayu Kelas I			10,214,600.00	1,206,000.00	11,420,600.00	11,420,600.00
	- Memasang 1 m ³ Kuda kuda Kayu Kelas II			5,814,600.00	1,206,000.00	7,020,600.00	7,020,600.00
	- Memasang 1 m ³ Kuda kuda Kayu Kelas III			2,984,600.00	1,206,000.00	4,190,600.00	4,190,600.00
13	Analisa SNI DPU Cipta Karya dan Tata Ruang						
	Upah Membongkar 1 m ³ Konstruksi Kuda kuda Konvensional, kayu klas I, II, dan III bentang 6 meter						
	Bahan						
	0.000 m ³ Balok Kayu Kelas I	Rp	9,000,000.00	-			
	0.000 m ³ Balok Kayu Kelas II	Rp	5,000,000.00	-			
	0.000 m ³ Balok Kayu Kelas III	Rp	3,000,000.00	-			
	0.000 Kg Besi strip tb = 5 mm /kawel	Rp	15,000.00	-			
	0.000 Kg Paku 12 cm	Rp	16,000.00	-			
	Upah						
	4.000 Oh Pekerja	Rp	65,000.00		260,000.00		
	12.000 Oh Tukang kayu	Rp	70,000.00		840,000.00		
	1.200 Oh Kepala Tukang	Rp	75,000.00		90,000.00		
	0.200 Oh Mandor	Rp	80,000.00		16,000.00		
	- Memasang 1 m ³ Kuda kuda Kayu Kelas I			-	1,206,000.00	1,206,000.00	1,206,000.00
	- Memasang 1 m ³ Kuda kuda Kayu Kelas II			-	1,206,000.00	1,206,000.00	1,206,000.00
	- Memasang 1 m ³ Kuda kuda Kayu Kelas III			-	1,206,000.00	1,206,000.00	1,206,000.00
14	Analisa SNI DPU Cipta Karya dan Tata Ruang						

	Memasang 1 m ³ Konstruksi Kuda kuda Ekspose kayu klas I				
	Bahan				
	1.200 m ³ Balok Kayu Kelas I	Rp 9,000,000.00	10,800,000.00		
	15.000 Kg Besi strip tb = 5 mm /kawel	Rp 15,000.00	225,000.00		
	5.600 Kg Paku 12 cm	Rp 16,000.00	89,600.00		
	Upah				
	6.700 Oh Pekerja	Rp 65,000.00		435,500.00	
	20.100 Oh Tukang kayu	Rp 70,000.00		1,407,000.00	
	2.010 Oh Kepala Tukang	Rp 75,000.00		150,750.00	
	0.335 Oh Mandor	Rp 80,000.00		26,800.00	
			11,114,600.00	2,020,050.00	13,134,650.00
	13,134,600.00				
15	Analisa SNI DPU Cipta Karya dan Tata Ruang				
	Memasang 1 m ³ Konstruksi Gording kayu klas III				
	Bahan				
	1.100 m ³ Balok Kayu Kelas III	Rp 3,000,000.00	3,300,000.00		
	15.000 Kg Besi strip tb = 5 mm /kawel	Rp 15,000.00	225,000.00		
	3.000 Kg Paku 12 cm	Rp 16,000.00	48,000.00		
	Upah				
	2.400 Oh Pekerja	Rp 65,000.00		156,000.00	
	7.200 Oh Tukang kayu	Rp 70,000.00		504,000.00	
	0.720 Oh Kepala Tukang	Rp 75,000.00		54,000.00	
	0.120 Oh Mandor	Rp 80,000.00		9,600.00	
			3,573,000.00	723,600.00	4,296,600.00
	4,296,600.00				
16	Analisa SNI DPU Cipta Karya dan Tata Ruang				
	Memasang 1 m ² rangka atap genteng keramik, kayu kl. II				
	Bahan				
	0.014 m ³ Kaso-kaso (5x7) cm kelas II	Rp 5,000,000.00	70,000.00		
	0.0036 m ³ Reng (2x3) cm	Rp 5,000,000.00	18,000.00		
	0.250 Kg Paku 5 dan 10 cm	Rp 16,000.00	4,000.00		
	Upah				

	0.100 Oh Pekerja	Rp	65,000.00		6,500.00		
	0.100 Oh Tukang kayu	Rp	70,000.00		7,000.00		
	0.010 Oh Kepala Tukang	Rp	75,000.00		750.00		
	0.005 Oh Mandor	Rp	80,000.00		400.00		
				92,000.00	14,650.00	106,650.00	106,600.00
17	Analisa SNI DPU Cipta Karya dan Tata Ruang						
	Memasang 1 m ² Reng genteng keramik, kayu kl. II						
	Bahan						
	0.0036 m ³ Reng (2x3) cm	Rp	5,000,000.00	18,000.00			
	0.150 Kg Paku 5 dan 10 cm	Rp	16,000.00	2,400.00			
	Upah						
	0.100 Oh Pekerja	Rp	65,000.00		6,500.00		
	0.100 Oh Tukang kayu	Rp	70,000.00		7,000.00		
	0.010 Oh Kepala Tukang	Rp	75,000.00		750.00		
	0.005 Oh Mandor	Rp	80,000.00		400.00		
				20,400.00	14,650.00	35,050.00	35,000.00
18	Analisa SNI DPU Cipta Karya dan Tata Ruang						
	Memasang 1 m ² rangka atap genteng beton, kayu kl. II						
	Bahan						
	0.014 m ³ Kaso-kaso (5x7) cm	Rp	5,000,000.00	70,000.00			
	0.0072 m ³ Reng (3x4) cm	Rp	5,000,000.00	36,000.00			
	0.250 Kg Paku 5 dan 10 cm	Rp	16,000.00	4,000.00			
	Upah						
	0.100 Oh Pekerja	Rp	65,000.00		6,500.00		
	0.100 Oh Tukang kayu	Rp	70,000.00		7,000.00		
	0.010 Oh Kepala Tukang	Rp	75,000.00		750.00		
	0.005 Oh Mandor	Rp	80,000.00		400.00		
				110,000.00	14,650.00	124,650.00	124,600.00
19	Analisa SNI DPU Cipta Karya dan Tata Ruang						
	Memasang 1 m ² rangka atap sirap, kayu kelas II						

	Bahan						
	0.165 m ³ Kayu kelas II	Rp	5,000,000.00	825,000.00			
	0.200 Kg Paku 5 dan 10 cm	Rp	16,000.00	3,200.00			
	Upah						
	0.120 Oh Pekerja	Rp	65,000.00		7,800.00		
	0.120 Oh Tukang kayu	Rp	70,000.00		8,400.00		
	0.012 Oh Kepala Tukang	Rp	75,000.00		900.00		
	0.006 Oh Mandor	Rp	80,000.00		480.00		
				828,200.00	17,580.00	845,780.00	845,700.00
20	Analisa SNI DPU Cipta Karya dan Tata Ruang						
	Memasang 1 m ² rangka langit-langit (50x100)cm, kayu kelas II						
	Bahan						
	0.0154 m ³ Kaso-kaso (5x7) cm	Rp	5,000,000.00	77,000.00			
	0.200 Kg Paku 7 dan 10 cm	Rp	16,000.00	3,200.00			
	Upah						
	0.150 Oh Pekerja	Rp	65,000.00		9,750.00		
	0.300 Oh Tukang kayu	Rp	70,000.00		21,000.00		
	0.030 Oh Kepala Tukang	Rp	75,000.00		2,250.00		
	0.075 Oh Mandor	Rp	80,000.00		6,000.00		
				80,200.00	39,000.00	119,200.00	119,200.00
21	Analisa SNI DPU Cipta Karya dan Tata Ruang						
	Memasang 1 m ² rangka langit-langit (60 x 60)cm, kayu kelas II						
	Bahan						
	0.0163 m ³ Kaso-kaso (5x7) cm	Rp	5,000,000.00	81,500.00			
	0.250 Kg Paku 7 dan 10 cm	Rp	16,000.00	4,000.00			
	Upah						
	0.200 Oh Pekerja	Rp	65,000.00		13,000.00		
	0.300 Oh Tukang kayu	Rp	70,000.00		21,000.00		
	0.030 Oh Kepala Tukang	Rp	75,000.00		2,250.00		
	0.010 Oh Mandor	Rp	80,000.00		800.00		
				85,500.00	37,050.00	122,550.00	122,500.00

22	Analisa SNI DPU Cipta Karya dan Tata Ruang				
	Memasang 1 m' lisplank ukuran (3 x 20)cm, kayu kelas I atau II				
	Bahan				
	0.0108 m ³ Papan kayu Kelas I Rp 10,000,000.00	108,000.00			
	0.0108 m ³ Papan kayu Kelas II Rp 5,000,000.00	54,000.00			
	0.100 Kg Paku 5 dan 7 cm Rp 16,000.00	1,600.00			
	Upah				
	0.100 Oh Pekerja Rp 65,000.00		6,500.00		
	0.200 Oh Tukang kayu Rp 70,000.00		14,000.00		
	0.020 Oh Kepala Tukang Rp 75,000.00		1,500.00		
	0.005 Oh Mandor Rp 80,000.00		400.00		
	Memasang lisplank uk (3 x 20)cmkayu kelas I	109,600.00	22,400.00	132,000.00	132,000.00
	Memasang lisplank uk (3 x 20)cmkayu kelas II	55,600.00	22,400.00	78,000.00	78,000.00
23	Analisa SNI DPU Cipta Karya dan Tata Ruang				
	Memasang 1 m' lisplank ukuran (3 x 30)cm, kayu kelas I atau II				
	Bahan				
	0.011 m ³ Papan kayu Kelas I Rp 10,000,000.00	110,000.00			
	0.011 m ³ Papan kayu Kelas II Rp 5,000,000.00	55,000.00			
	0.050 Kg Paku 5 dan 7 cm Rp 16,000.00	800.00			
	Upah				
	0.100 Oh Pekerja Rp 65,000.00		6,500.00		
	0.200 Oh Tukang kayu Rp 70,000.00		14,000.00		
	0.020 Oh Kepala Tukang Rp 75,000.00		1,500.00		
	0.005 Oh Mandor Rp 80,000.00		400.00		
	- Memasang lisplank uk (3 x 30)cmkayu kelas I	110,800.00	22,400.00	133,200.00	133,200.00
	- Memasang lisplank uk (3 x 30)cmkayu kelas II	55,800.00	22,400.00	78,200.00	78,200.00
24	Analisa SNI DPU Cipta Karya dan Tata Ruang				
	Memasang 1 m ² rangka dinding pemisah teakwood rangkap, rangka kayu kelas II				
	Bahan				
	0.028 m ³ Balok Kayu Rp 5,000,000.00	140,000.00			

	0.150 Kg Paku 5 dan 7 cm	Rp	16,000.00	2,400.00			
	0.860 Lbr Teakwood	Rp	82,000.00	70,520.00			
	0.560 Kg Lem kayu	Rp	11,500.00	6,440.00			
	Upah						
	0.150 Oh Pekerja	Rp	65,000.00	9,750.00			
	0.450 Oh Tukang kayu	Rp	70,000.00	31,500.00			
	0.045 Oh Kepala Tukang	Rp	75,000.00	3,375.00			
	0.008 Oh Mandor	Rp	80,000.00	640.00			
				219,360.00	45,265.00	264,625.00	264,600.00
25	Analisa SNI DPU Cipta Karya dan Tata Ruang						
	Memasang 1 m ² rangka dinding pemisah plywood rangkap, rangka kayu kelas II						
	Bahan						
	0.028 m ³ Balok Kayu	Rp	5,000,000.00	140,000.00			
	0.150 Kg Paku 5 dan 7 cm	Rp	16,000.00	2,400.00			
	0.860 Lbr Plywood tebal 4mm (90x220)	Rp	85,000.00	73,100.00			
	0.560 Kg Lem kayu	Rp	11,500.00	6,440.00			
	Upah						
	0.200 Oh Pekerja	Rp	65,000.00	13,000.00			
	0.600 Oh Tukang kayu	Rp	70,000.00	42,000.00			
	0.060 Oh Kepala Tukang	Rp	75,000.00	4,500.00			
	0.010 Oh Mandor	Rp	80,000.00	800.00			
				221,940.00	60,300.00	282,240.00	282,200.00
26	Analisa SNI DPU Cipta Karya dan Tata Ruang						
	Memasang 1 m ² rangka dinding pemisah plywood rangkap lapis HPL, rangka kayu kelas II						
	Bahan						
	0.028 m ³ Balok Kayu	Rp	5,000,000.00	140,000.00			
	0.150 Kg Paku 5 dan 7 cm	Rp	16,000.00	2,400.00			
	0.860 Lbr Plywood tebal 9 mm (1200x2	Rp	98,000.00	84,280.00			
	0.560 Kg Lem kayu	Rp	11,500.00	6,440.00			
	0.860 Lbr HPL	Rp	215,000.00	184,900.00			
	Upah						

	0.200 Oh Pekerja	Rp	65,000.00		13,000.00		
	0.600 Oh Tukang kayu	Rp	70,000.00		42,000.00		
	0.060 Oh Kepala Tukang	Rp	75,000.00		4,500.00		
	0.010 Oh Mandor	Rp	80,000.00		800.00		
				418,020.00	60,300.00	478,320.00	478,300.00
27	Analisa SNI DPU Cipta Karya dan Tata Ruang						
	Memasang 1 m² rangka dinding pemisah plywood rangkap lapis Wallpaper, rangka kayu kelas II						
	Bahan						
	0.028 m ³ Balok Kayu	Rp	5,000,000.00	140,000.00			
	0.150 Kg Paku 5 dan 7 cm	Rp	16,000.00	2,400.00			
	0.860 Lbr Plywood tebal 9 mm (1200x2	Rp	98,000.00	84,280.00			
	0.560 Kg Lem kayu	Rp	11,500.00	6,440.00			
	0.440 Lbr Wallpaper	Rp	240,000.00	105,600.00			
	Upah						
	0.200 Oh Pekerja	Rp	65,000.00		13,000.00		
	0.600 Oh Tukang kayu	Rp	70,000.00		42,000.00		
	0.060 Oh Kepala Tukang	Rp	75,000.00		4,500.00		
	0.010 Oh Mandor	Rp	80,000.00		800.00		
				338,720.00	60,300.00	399,020.00	399,000.00
28	Analisa SNI DPU Cipta Karya dan Tata Ruang						
	Memasang 1 rangka dinding pemisah plywood rangkap lapis HPL,PR1						
	Upah dan Bahan						
	1.800 m ² Partisi Lapis HPL	Rp	478,300.00	860,940.00			
	0.840 m ² Partisi Lapis Walpaper	Rp	399,000.00	335,160.00			
				1,196,100.00	-	1,196,100.00	1,196,100.00
29	Analisa SNI DPU Cipta Karya dan Tata Ruang						
	Memasang 1 rangka dinding pemisah plywood rangkap lapis HPL,PR2						
	Upah dan Bahan						
	1.125 m ² Partisi Lapis HPL	Rp	478,300.00	538,087.50			

	0.525 m ² Partisi Lapis Walpaper	Rp	399,000.00	209,475.00			
				747,562.50	-	747,562.50	747,500.00
30	Analisa SNI DPU Cipta Karya dan Tata Ruang						
	Memasang rangka dinding pemisah plywood rangkap lapis HPL,PR3						
	Upah dan Bahan						
	1.650 m ² Partisi Lapis HPL	Rp	478,300.00	789,195.00			
	0.770 m ² Partisi Lapis Walpaper	Rp	399,000.00	307,230.00			
				1,096,425.00	-	1,096,425.00	1,096,400.00
31	Analisa SNI DPU Cipta Karya dan Tata Ruang						
	Memasang rangka dinding pemisah plywood rangkap lapis HPL,PR4						
	Upah dan Bahan						
	3.000 m ² Partisi Lapis HPL	Rp	478,300.00	1,434,900.00			
	1.400 m ² Partisi Lapis Walpaper	Rp	399,000.00	558,600.00			
				1,993,500.00	-	1,993,500.00	1,993,500.00
32	Analisa SNI DPU Cipta Karya dan Tata Ruang						
	Memasang rangka dinding pemisah plywood rangkap lapis HPL,PR5						
	Upah dan Bahan						
	0.600 m ² Partisi Lapis HPL	Rp	478,300.00	286,980.00			
	10.800 m ² Partisi Lapis Walpaper	Rp	399,000.00	4,309,200.00			
				4,596,180.00	-	4,596,180.00	4,596,100.00
33	Analisa SNI DPU Cipta Karya dan Tata Ruang						
	Memasang rangka dinding pemisah plywood rangkap lapis HPL,PR6						
	Upah dan Bahan						
	0.560 m ² Partisi Lapis HPL	Rp	478,300.00	267,848.00			
	10.080 m ² Partisi Lapis Walpaper	Rp	399,000.00	4,021,920.00			
				4,289,768.00	-	4,289,768.00	4,289,700.00
34	Analisa SNI DPU Cipta Karya dan Tata Ruang						
	Memasang rangka dinding pemisah plywood rangkap lapis HPL,Etalase						
	Upah dan Bahan						
	8.900 m ² Partisi Lapis HPL	Rp	478,300.00	4,256,870.00			

	9.200 m ² Kaca 8 mm	Rp	151,000.00	1,389,200.00			
	2.000 bh Lampu TL 40 W / 220 V Kon	Rp	165,000.00	330,000.00			
				5,976,070.00	-	5,976,070.00	5,976,000.00
35	Analisa SNI DPU Cipta Karya dan Tata Ruang						
	Memasang rangka dinding pemisah plywood rangkap lapis HPL,entrance						
	Upah dan Bahan						
	6.528 m ² Partisi Lapis HPL	Rp	478,300.00	3,122,103.25			
				3,122,103.25	-	3,122,103.25	3,122,100.00
36	Analisa SNI DPU Cipta Karya dan Tata Ruang						
	Memasang 1 m ² dinding Lambriziring dari papan kayu kelas I						
	Bahan						
	0.007 m ³ Papan kayu	Rp	10,000,000.00	70,000.00			
	0.100 Kg Paku 5 dan 10 cm	Rp	16,000.00	1,600.00			
	0.150 Kg Paku skrup 10 cm	Rp	55,000.00	8,250.00			
	Upah						
	0.600 Oh Pekerja	Rp	65,000.00		39,000.00		
	1.800 Oh Tukang kayu	Rp	70,000.00		126,000.00		
	0.180 Oh Kepala Tukang	Rp	75,000.00		13,500.00		
	0.030 Oh Mandor	Rp	80,000.00		2,400.00		
				79,850.00	180,900.00	260,750.00	260,700.00
37	Analisa SNI DPU Cipta Karya dan Tata Ruang						
	Memasang 1 m2 Pasang Papan Kompres tebal 2,5 cm, kayu papan kls. I						
	Bahan						
	0.0275 m ³ Papan kayu Kelas I	Rp	10,000,000.00	275,000.00			
	0.100 m ³ Paku 5 cm dan 10 cm	Rp	16,000.00	1,600.00			
	Upah						
	0.080 Oh Pekerja	Rp	65,000.00		5,200.00		
	0.800 Oh Tukang kayu	Rp	70,000.00		56,000.00		
	0.280 Oh Kepala Tukang	Rp	75,000.00		21,000.00		

	0.014 Oh Mandor	Rp	80,000.00		1,120.00			
				276,600.00	83,320.00	359,920.00	359,900.00	
38	Analisa SNI DPU Cipta Karya dan Tata Ruang							
	Memasang 1 m2 Papan reuter 2/20 cm kayu meranti Kelas II							
	Bahan							
	0.0040 m ³	Papan kayu Kelas II	Rp	6,000,000.00	24,000.00			
	0.020 m ³	Paku 5 cm dan 10 cm	Rp	16,000.00	320.00			
	Upah							
	0.008 Oh	Pekerja	Rp	65,000.00	520.00			
	0.080 Oh	Tukang kayu	Rp	70,000.00	5,600.00			
	0.028 Oh	Kepala Tukang	Rp	75,000.00	2,100.00			
	0.001 Oh	Mandor	Rp	80,000.00	112.00			
				24,320.00	8,332.00	32,652.00	32,600.00	
39	Analisa SNI DPU Cipta Karya dan Tata Ruang							
	Memasang 1 m2 rangka langit-langit (100 x 100) cm							
	Bahan							
	0.0120 m ³	Balok 5/7 kayu kelas II	Rp	5,000,000.00	60,000.00			
	0.020 m ³	Paku 5 cm dan 10 cm	Rp	16,000.00	320.00			
	Upah							
	0.008 Oh	Pekerja	Rp	65,000.00	520.00			
	0.080 Oh	Tukang kayu	Rp	70,000.00	5,600.00			
	0.028 Oh	Kepala Tukang	Rp	75,000.00	2,100.00			
	0.001 Oh	Mandor	Rp	80,000.00	112.00			
				60,320.00	8,332.00	68,652.00	68,600.00	

ANALISA SATUAN PEKERJAAN KABUPATEN JEMBER 2017

Pekerjaan Baja

NO.	JENIS PEKERJAAN	BAHAN	UPAH	JUMLAH	BULAT
1	2	3	4	5	6
1	Analisa Sendiri				
	Pek. wf 200.100.5,5.8mm				
	Bahan				
	1.000 kg wf 200.100.5,5.8mm	Rp	7,000.00	7,000.00	
	Upah				
	1.000 Ls Upah pasang	Rp	1,050.00	1,050.00	
			7,000.00	1,050.00	8,050.00
					8,000.00
2	Analisa Sendiri				
	Plat bertulang 6mm				
	Bahan				
	1.000 kg Plat bertulang 6mm	Rp	7,000.00	7,000.00	
	Upah				
	1.000 Ls Upah pasang	Rp	1,050.00	1,050.00	
			7,000.00	1,050.00	8,050.00
					8,000.00
3	Analisa Sendiri				
	Plat plendes kuda-kuda 8mm				
	Bahan				
	1.000 kg Plat plendes kuda-kuda 8mm	Rp	7,000.00	7,000.00	
	Upah				
	1.000 Ls Upah pasang	Rp	1,050.00	1,050.00	
			7,000.00	1,050.00	8,050.00
					8,000.00
4	Analisa Sendiri				
	Plat sepatu kolom 10mm				
	Bahan				
	1.000 kg Plat sepatu kolom 10mm	Rp	7,000.00	7,000.00	

	Upah							
	1.000 Ls	Upah pasang	Rp	1,050.00		1,050.00		
					7,000.00	1,050.00	8,050.00	8,000.00
5	Analisa Sendiri							
	Trek hordeng bs 10mm							
	Bahan							
	1.000 kg	Trek hordeng bs 10mm	Rp	10,000.00	10,000.00			
	Upah							
	1.000 Ls	Upah pasang	Rp	1,500.00		1,500.00		
					10,000.00	1,500.00	11,500.00	11,500.00
6	Analisa Sendiri							
	Tali angin bs 12mm							
	Bahan							
	1.000 kg	Tali angin bs 12mm	Rp	10,000.00	10,000.00			
	Upah							
	1.000 Ls	Upah pasang	Rp	1,500.00		1,500.00		
					10,000.00	1,500.00	11,500.00	11,500.00
7	Analisa Sendiri							
	Spansecruw M-16							
	Bahan							
	1.000 unit	Spansecruw M-16	Rp	45,000.00	45,000.00			
	Upah							
	1.000 Ls	Upah pasang	Rp	6,750.00		6,750.00		
					45,000.00	6,750.00	51,750.00	51,700.00
8	Analisa Sendiri							
	Baut angkur 12mm							
	Bahan							
	1.000 bj	Baut angkur 12mm	Rp	25,000.00	25,000.00			
	Upah							
	1.000 Ls	Upah pasang	Rp	3,750.00		3,750.00		
					25,000.00	3,750.00	28,750.00	28,700.00

9	Analisa Sendiri						
	Baut kuda-kuda 1/2 x 1 1/2 inc						
	Bahan						
	1.000 bj	Baut kuda-kuda 1/2 x 1 1/2 inc	Rp	2,000.00	2,000.00		
	Upah						
	1.000 Ls	Upah pasang	Rp	300.00		300.00	
					2,000.00	300.00	2,300.00
							2,300.00
10	Analisa Sendiri						
	Baut hordeng & trek hordeng						
	Bahan						
	1.000 bj	Baut hordeng & trek hordeng	Rp	1,500.00	1,500.00		
	Upah						
	1.000 Ls	Upah pasang	Rp	225.00		225.00	
					1,500.00	225.00	1,725.00
							1,700.00
11	Analisa Sendiri						
	CNP.150. 50. 2,3mm						
	Bahan						
	1.000 kg	CNP.150. 50. 2,3mm	Rp	12,000.00	12,000.00		
	Upah						
	1.000 Ls	Upah pasang	Rp	1,800.00		1,800.00	
					12,000.00	1,800.00	13,800.00
							13,800.00
12	Analisa Sendiri						
	Driling secruw 3 inc						
	Bahan						
	1.000 pcs	Driling secruw 3 inc	Rp	1,000.00	1,000.00		
	Upah						
	1.000 Ls	Upah pasang	Rp	150.00		150.00	
					1,000.00	150.00	1,150.00
							1,100.00
13	Analisa Sendiri						
	1 m2 Pasang rangka atap baja ringan sudut 30-35-40-45 derajat bentang maximal 10 m						
	Bahan						

	2.100 m	C75.75	Rp	11,500.00	24,150.00			
	1.670 m	C75.95	Rp	13,500.00	22,545.00			
	6.050 m	Reng galvalum	Rp	32,000.00	193,600.00			
	26.000 m	Screw	Rp	500.00	13,000.00			
	1.000 pcs	Dynabolt	Rp	4,000.00	4,000.00			
	0.600 m	Plat bracing	Rp	12,000.00	7,200.00			
	Upah							
	1.000 Ls	Upah pasang	Rp	39,674.25		39,674.25		
					264,495.00	39,674.25	304,169.25	304,100.00

ANALISA SATUAN PEKERJAAN KABUPATEN JEMBER 2017

Pekerjaan Beton

NO.	JENIS PEKERJAAN		BAHAN	UPAH	JUMLAH	BULAT
1	2		3	4	5	6
	HARGA UNTUK 1 M3 BETON BERTULANG STRUKTUR (Bahan + Upah)					
	Analisa 1 m3 Beton Bertulang Struktur (SLOOF) K.175					
	Spesifikasi pembedian SNI (Utama Ø 10 mm - Beugel Ø 6 mm)					
1	Pasang SLOOF 15/20 K. 175 (Ø 10 mm - Beugel Ø 6 mm)					
	1.00	M3	Mengecor beton K-175 Rp	1,123,700.00	1,123,700.00	
	116.67	Kg	Pembedian besi beton polos Rp	96,500.00	11,258,841.57	
	10.00	M2	Bekisting untuk sloof Rp	181,200.00	1,812,000.00	
					14,194,541.57	14,194,600.00
	Analisa 1 m3 Beton Bertulang Struktur (KOLOM) K.175					
	Spesifikasi pembedian SNI (Utama Ø 10-12 mm - Beugel Ø 6-8 mm)					
2	Pasang KOLOM 15/15 K. 175 (Ø 10 mm - Beugel Ø 6 mm)					
	1.00	M3	Mengecor beton K-175 Rp	1,123,700.00	1,123,700.00	
	148.99	Kg	Pembedian besi beton polos Rp	96,500.00	14,377,487.82	
	26.67	M2	Bekisting untuk kolom Rp	170,200.00	4,538,666.67	
					20,039,854.49	20,039,900.00
3	Pasang KOLOM 15/30 K. 175 (Ø 12 mm - Beugel Ø 8 mm)					
	1.00	M3	Mengecor beton K-175 Rp	1,123,700.00	1,123,700.00	
	158.85	Kg	Pembedian besi beton polos Rp	96,500.00	15,328,939.22	
	20.00	M2	Bekisting untuk kolom Rp	170,200.00	3,404,000.00	
					19,856,639.22	19,856,700.00

		Analisa 1 m3 Beton Bertulang Struktur (BALOK) K.175						
		Spesifikasi pembedian SNI (Utama Ø 12 mm - Beugel Ø 6 mm)						
4		Pasang BALOK 15/20 K. 175 (Ø 12 mm - Beugel Ø 8 mm)						
	1.00	M3	Mengecor beton K-175	Rp 1,123,700.00		1,123,700.00		
	179.66	Kg	Pembedian besi beton polos	Rp 96,500.00		17,337,558.84		
	16.67	M2	Bekisting untuk balok	Rp 174,700.00		2,911,666.67		
						21,372,925.51	21,372,925.51	21,373,000.00
5		Pasang BALOK LATAI 12/15 K. 175 (Ø 10 mm - Beugel Ø 6 mm)						
	1.00	M3	Mengecor beton K-175	Rp 1,123,700.00		1,123,700.00		
	181.31	Kg	Pembedian besi beton polos	Rp 96,500.00		17,496,134.08		
	21.67	M2	Bekisting untuk balok	Rp 174,700.00		3,785,166.67		
						22,405,000.74	22,405,000.74	22,405,100.00
		Analisa 1 m3 Beton Bertulang Struktur (PLAT) K.175						
		Spesifikasi pembedian SNI (Utama Ø 12 mm - Beugel Ø 6 mm)						
6		Pasang PLAT 12cm K. 175 (Ø 12 mm - Ø 10 mm)						
	1.00	M3	Mengecor beton K-175	Rp 1,123,700.00		1,123,700.00		
	167.07	Kg	Pembedian besi beton polos	Rp 96,500.00		16,121,815.39		
	8.33	M2	Bekisting untuk plat	Rp 196,200.00		1,635,000.00		
						18,880,515.39	18,880,515.39	18,880,600.00
A	MEMBUAT BETON 1 M3							
1	Analisa SNI Dinas PU. Cipta Karya dan Tata Ruang							
	Membuat 1 m3 Beton mutu $f_c = 7,4$ Mpa (K100), slump (12 ± 2) cm, W/C = 0.87							
	Bahan							
\	247.00	Kg	PC	Rp 2,000.00		494,000.00		
	869.00	Kg	Pasir beton (Pasir Kali)	Rp 140.00		121,660.00		

	999.00 Kg	Kerikil (max. 30 mm)	Rp	140.00	139,860.00			
	215.00 ltr	Air	Rp	400.00	86,000.00			
	Upah							
	1.650 Oh	Pekerja	Rp	65,000.00		107,250.00		
	0.275 Oh	Tukang batu	Rp	70,000.00		19,250.00		
	0.028 Oh	Kepala tukang	Rp	75,000.00		2,100.00		
	0.083 Oh	Mandor	Rp	80,000.00		6,640.00		
					841,520.00	135,240.00	976,760.00	976,700.00
2	Analisa SNI Dinas PU. Cipta Karya dan Tata Ruang							
	Membuat 1 m3 Beton mutu f'c = 9,8 Mpa (K125), slump (12 ± 2) cm, W/C = 0.78							
	Bahan							
	276.00 Kg	PC	Rp	2,000.00	552,000.00			
	828.000 Kg	Pasir beton (Pasir Kali)	Rp	140.00	115,920.00			
	1012.00 Kg	Kerikil (max. 30 mm)	Rp	140.00	141,680.00			
	215.000 ltr	Air	Rp	400.00	86,000.00			
	Upah							
	1.650 Oh	Pekerja	Rp	65,000.00		107,250.00		
	0.275 Oh	Tukang batu	Rp	70,000.00		19,250.00		
	0.028 Oh	Kepala tukang	Rp	75,000.00		2,100.00		
	0.083 Oh	Mandor	Rp	80,000.00		6,640.00		
					895,600.00	135,240.00	1,030,840.00	1,030,800.00
3	Analisa SNI Dinas PU. Cipta Karya dan Tata Ruang							
	Membuat 1 m3 Beton mutu f'c = 12,2 Mpa (K150), slump (12 ± 2) cm, W/C = 0.72							
	Bahan							
	299.00 Kg	PC	Rp	2,000.00	598,000.00			
	799.000 Kg	Pasir beton (Pasir Kali)	Rp	140.00	111,860.00			
	1017.00 Kg	Kerikil (max. 30 mm)	Rp	140.00	142,380.00			
	215.000 ltr	Air	Rp	400.00	86,000.00			
	Upah							
	1.650 Oh	Pekerja	Rp	65,000.00		107,250.00		
	0.275 Oh	Tukang batu	Rp	70,000.00		19,250.00		

	0.028 Oh	Kepala tukang	Rp	75,000.00		2,100.00		
	0.083 Oh	Mandor	Rp	80,000.00		6,640.00		
					938,240.00	135,240.00	1,073,480.00	1,073,400.00
4	Analisa SNI Dinas PU. Cipta Karya dan Tata Ruang							
	Membuat 1 m ³ beton mutu f _c = 14,5 Mpa (K175), slump (12 ± 2) cm, W/C = 0.66							
	Bahan							
	326.000 Kg	PC	Rp	2,000.00	652,000.00			
	760.000 Kg	Pasir beton (Pasir Kali)	Rp	140.00	106,400.00			
	1029.00 Kg	Kerikil (max. 30 mm)	Rp	140.00	144,060.00			
	215.000 ltr	Air	Rp	400.00	86,000.00			
	Upah							
	1.650 Oh	Pekerja	Rp	65,000.00		107,250.00		
	0.275 Oh	Tukang batu	Rp	70,000.00		19,250.00		
	0.028 Oh	Kepala tukang	Rp	75,000.00		2,100.00		
	0.083 Oh	Mandor	Rp	80,000.00		6,640.00		
					988,460.00	135,240.00	1,123,700.00	1,123,700.00
5	Analisa SNI Dinas PU. Cipta Karya dan Tata Ruang							
	Membuat 1 m ³ beton mutu f _c = 16,9 Mpa (K200), slump (12 ± 2) cm, W/C = 0.61							
	Bahan							
	352.000 Kg	PC	Rp	2,000.00	704,000.00			
	731.000 Kg	Pasir beton (Pasir Kali)	Rp	140.00	102,340.00			
	1031.00 Kg	Kerikil (max. 30 mm)	Rp	140.00	144,340.00			
	215.000 ltr	Air	Rp	400.00	86,000.00			
	Upah							
	1.650 Oh	Pekerja	Rp	65,000.00		107,250.00		
	0.275 Oh	Tukang batu	Rp	70,000.00		19,250.00		
	0.028 Oh	Kepala tukang	Rp	75,000.00		2,100.00		
	0.083 Oh	Mandor	Rp	80,000.00		6,640.00		
					1,036,680.00	135,240.00	1,171,920.00	1,171,900.00
6	Analisa SNI Dinas PU. Cipta Karya dan Tata Ruang							

	Membuat 1 m3 beton mutu $f_c = 19,3$ Mpa (K225), slump (12 ± 2) cm, W/C = 0.58							
	Bahan							
	371.000 Kg	PC	Rp	2,000.00	742,000.00			
	698.000 Kg	Pasir beton (Pasir Kali)	Rp	140.00	97,720.00			
	1047.00 Kg	Kerikil (max. 30 mm)	Rp	140.00	146,580.00			
	215.000 ltr	Air	Rp	400.00	86,000.00			
	Upah							
	1.650 Oh	Pekerja	Rp	65,000.00		107,250.00		
	0.275 Oh	Tukang batu	Rp	70,000.00		19,250.00		
	0.028 Oh	Kepala tukang	Rp	75,000.00		2,100.00		
	0.083 Oh	Mandor	Rp	80,000.00		6,640.00		
					1,072,300.00	135,240.00	1,207,540.00	1,207,500.00
7	Analisa SNI Dinas PU. Cipta Karya dan Tata Ruang							
	Membuat 1 m3 beton mutu $f_c = 21.7$ Mpa (K250), slump (12 ± 2) cm, W/C = 0.56							
	Bahan							
	384.000 Kg	PC	Rp	2,000.00	768,000.00			
	692.000 Kg	Pasir beton (Pasir Kali)	Rp	140.00	96,880.00			
	1039.00 Kg	Kerikil (max. 30 mm)	Rp	140.00	145,460.00			
	215.000 ltr	Air	Rp	400.00	86,000.00			
	Upah							
	1.650 Oh	Pekerja	Rp	65,000.00		107,250.00		
	0.275 Oh	Tukang batu	Rp	70,000.00		19,250.00		
	0.028 Oh	Kepala tukang	Rp	75,000.00		2,100.00		
	0.083 Oh	Mandor	Rp	80,000.00		6,640.00		
					1,096,340.00	135,240.00	1,231,580.00	1,231,500.00
8	Analisa SNI Dinas PU. Cipta Karya dan Tata Ruang							
	Membuat 1 m3 beton mutu $f_c = 24.0$ Mpa (K275), slump (12 ± 2) cm, W/C = 0.53							
	Bahan							
	406.000 Kg	PC	Rp	2,000.00	812,000.00			
	684.000 Kg	Pasir beton (Pasir Kali)	Rp	140.00	95,760.00			
	1026.00 Kg	Kerikil (max. 30 mm)	Rp	140.00	143,640.00			

	215.000 ltr	Air	Rp	400.00	86,000.00			
	Upah							
	1.650 Oh	Pekerja	Rp	65,000.00		107,250.00		
	0.275 Oh	Tukang batu	Rp	70,000.00		19,250.00		
	0.028 Oh	Kepala tukang	Rp	75,000.00		2,100.00		
	0.083 Oh	Mandor	Rp	80,000.00		6,640.00		
					1,137,400.00	135,240.00	1,272,640.00	1,272,600.00
9	Analisa SNI Dinas PU. Cipta Karya dan Tata Ruang							
	Membuat 1 m3 beton mutu f'c = 26.4 Mpa (K300), slump (12 ± 2) cm, W/C = 0.52							
	Bahan							
	413.000 Kg	PC	Rp	2,000.00	826,000.00			
	681.000 Kg	Pasir beton (Pasir Kali)	Rp	140.00	95,340.00			
	1021.00 Kg	Kerikil (max. 30 mm)	Rp	140.00	142,940.00			
	215.000 ltr	Air	Rp	400.00	86,000.00			
	Upah							
	1.650 Oh	Pekerja	Rp	65,000.00		107,250.00		
	0.275 Oh	Tukang batu	Rp	70,000.00		19,250.00		
	0.028 Oh	Kepala tukang	Rp	75,000.00		2,100.00		
	0.083 Oh	Mandor	Rp	80,000.00		6,640.00		
					1,150,280.00	135,240.00	1,285,520.00	1,285,500.00
10	Analisa SNI Dinas PU. Cipta Karya dan Tata Ruang							
	Membuat 1 m3 beton mutu f'c = 31.2 Mpa (K350), slump (12 ± 2) cm, W/C = 0.48							
	Bahan							
	448.000 Kg	PC	Rp	2,000.00	896,000.00			
	667.000 Kg	Pasir beton (Pasir Kali)	Rp	140.00	93,380.00			
	1000.00 Kg	Kerikil (max. 30 mm)	Rp	140.00	140,000.00			
	215.000 ltr	Air	Rp	400.00	86,000.00			
	Upah							
	2.100 Oh	Pekerja	Rp	65,000.00		136,500.00		
	0.350 Oh	Tukang batu	Rp	70,000.00		24,500.00		
	0.035 Oh	Kepala tukang	Rp	75,000.00		2,625.00		

	0.105	Oh	Mandor	Rp	80,000.00		8,400.00		
						1,215,380.00	172,025.00	1,387,405.00	1,387,400.00
B	Analisa SNI Dinas PU. Cipta Karya dan Tata Ruang								
	Pembesian per 10 Kg Besi polos atau besi ulir								
	Bahan								
	10.50	Kg	Besi Beton Polos	Rp	8,000.00	84,000.00			
	0.15	Kg	Kawat Bendrat	Rp	15,000.00	2,250.00			
	Upah								
	0.070	Oh	Pekerja	Rp	65,000.00		4,550.00		
	0.070	Oh	Tukang batu	Rp	70,000.00		4,900.00		
	0.007	Oh	Kepala tukang	Rp	75,000.00		525.00		
	0.004	Oh	Mandor	Rp	80,000.00		320.00		
	Pembesian per 10 Kg Besi polos atau besi ulir					86,250.00	10,295.00	96,545.00	96,500.00
0.1	Pembesian per 1 Kg Besi polos					8,625.00	1,029.50	9,654.50	9,650.00
C	Analisa SNI Dinas PU. Cipta Karya dan Tata Ruang								
1	Memasang 1 m2 bekisting untuk pondasi								
	Bahan								
	0.040	M3	Kayu sengan / bekisting	Rp	3,000,000.00	120,000.00			
	0.300	Kg	Paku	Rp	16,000.00	4,800.00			
	0.100	Liter	Minyak Olie	Rp	4,000.00	400.00			
	Upah								
	0.520	Oh	Pekerja	Rp	65,000.00		33,800.00		
	0.260	Oh	Tukang batu	Rp	70,000.00		18,200.00		
	0.026	Oh	Kepala tukang	Rp	75,000.00		1,950.00		
	0.026	Oh	Mandor	Rp	80,000.00		2,080.00		
	Memasang 1 m2 bekisting untuk pondasi					125,200.00	56,030.00	181,230.00	181,200.00
2	Analisa SNI Dinas PU. Cipta Karya dan Tata Ruang								
	Memasang 1 m2 Bekisting untuk Sloof								
	Bahan								
	0.040	M3	Kayu sengan / bekisting	Rp	3,000,000.00	120,000.00			
	0.300	Kg	Paku	Rp	16,000.00	4,800.00			

	0.100	Liter	Minyak Olie	Rp	4,000.00	400.00			
	Upah								
	0.520	Oh	Pekerja	Rp	65,000.00		33,800.00		
	0.260	Oh	Tukang batu	Rp	70,000.00		18,200.00		
	0.026	Oh	Kepala tukang	Rp	75,000.00		1,950.00		
	0.026	Oh	Mandor	Rp	80,000.00		2,080.00		
	Memasang 1 m2 Bekisting untuk Sloof					125,200.00	56,030.00	181,230.00	181,200.00
3	Analisa SNI Dinas PU. Cipta Karya dan Tata Ruang								
	Memasang 1 m2 Bekisting untuk Kolom								
	Bahan								
	0.040	M3	Kayu sengon / bekisting	Rp	3,000,000.00	120,000.00			
	0.400	Kg	Paku	Rp	16,000.00	6,400.00			
	0.200	Liter	Minyak Olie	Rp	4,000.00	800.00			
	0.350	Lbr	Plywood tebal 9 mm	Rp	-	-			
	0.015	M3	Kayu sengon / bekisting	Rp	3,000,000.00	45,000.00			
	2.000	Btg	Bambu dim 6-10 cm	Rp	13,000.00	26,000.00			
	Upah								
	0.660	Oh	Pekerja	Rp	65,000.00		42,900.00		
	0.330	Oh	Tukang batu	Rp	70,000.00		23,100.00		
	0.033	Oh	Kepala tukang	Rp	75,000.00		2,475.00		
	0.033	Oh	Mandor	Rp	80,000.00		2,640.00		
	Memasang 1 m2 Bekisting untuk Kolom					198,200.00	71,115.00	269,315.00	269,300.00
	Memasang 1 m2 Bekisting untuk Kolom 2X PAKAI					99,100.00	71,115.00	170,215.00	170,200.00
4	Analisa SNI Dinas PU. Cipta Karya dan Tata Ruang								
	Memasang 1 m2 Bekisting untuk Balok								
	Bahan								
	0.040	M3	Kayu sengon / bekisting	Rp	3,000,000.00	120,000.00			
	0.400	Kg	Paku	Rp	16,000.00	6,400.00			
	0.200	Liter	Minyak Olie	Rp	4,000.00	800.00			
	0.350	Lbr	Plywood tebal 9 mm	Rp	-	-			
	0.018	M3	Kayu sengon / bekisting	Rp	3,000,000.00	54,000.00			

	2.000	Btg	Bambu dim 6-10 cm	Rp	13,000.00	26,000.00			
	Upah								
	0.660	Oh	Pekerja	Rp	65,000.00		42,900.00		
	0.330	Oh	Tukang batu	Rp	70,000.00		23,100.00		
	0.033	Oh	Kepala tukang	Rp	75,000.00		2,475.00		
	0.033	Oh	Mandor	Rp	80,000.00		2,640.00		
	Memasang 1 m2 Bekisting untuk Balok					207,200.00	71,115.00	278,315.00	278,300.00
	Memasang 1 m2 Bekisting untuk Balok 2X PAKAI					103,600.00	71,115.00	174,715.00	174,700.00
5	Analisa SNI Dinas PU. Cipta Karya dan Tata Ruang								
	Memasang 1 m2 bekisting untuk Lantai								
	Bahan								
	0.040	M3	Kayu sengon / bekisting	Rp	3,000,000.00	120,000.00			
	0.400	Kg	Paku	Rp	16,000.00	6,400.00			
	0.200	Liter	Minyak Olie	Rp	4,000.00	800.00			
	0.350	Lbr	Plywood tebal 9 mm	Rp	-	-			
	0.015	M3	Kayu sengon / bekisting	Rp	3,000,000.00	45,000.00			
	6.000	Btg	Bambu dim 6-10 cm	Rp	13,000.00	78,000.00			
	Upah								
	0.660	Oh	Pekerja	Rp	65,000.00		42,900.00		
	0.330	Oh	Tukang Kayu	Rp	70,000.00		23,100.00		
	0.033	Oh	Kepala Tukang	Rp	75,000.00		2,475.00		
	0.033	Oh	Mandor	Rp	80,000.00		2,640.00		
	Memasang 1 m2 bekisting untuk Lantai					250,200.00	71,115.00	321,315.00	321,300.00
	Memasang 1 m2 Bekisting untuk Lantai 2X PAKAI					125,100.00	71,115.00	196,215.00	196,200.00
	HARGA 1 M3 BETON BERTULANG STRUKTUR								
	BALOK Ukuran 35 X 75 CM (besi D 22 mm + D 16 mØ 22 m, begel Ø 10 m								
	1.00	M3	Mengecor beton K-275		1,272,600.00		1,272,600.00		
	21.82	Kg	Besi Polos		9,650.00		210,553.81		
	118.11	Kg	Besi Ulir		9,650.00		1,139,802.86		
	1.000	M2	Memasang bekisting untuk balok		174,700.00		174,700.00		
							2,797,656.67	2,797,656.67	2,797,600.00

HARGA 1 M3 BETON BERTULANG STRUKTUR				
BALOK Ukuran 20 X 40 CM (D 16 mm - Beugel Ø 10 mm)				
1.000 M3	Mengecor beton K-275	1,272,600.00	1,272,600.00	
27.897 Kg	Besi Polos	9,650.00	269,204.84	
118.350 Kg	Besi Ulir	9,650.00	1,142,077.50	
1.000 M2	Memasang bekisting untuk balok	174,700.00	174,700.00	
			2,858,582.34	2,858,582.34
				2,858,500.00
HARGA 1 M3 BETON BERTULANG STRUKTUR				
BALOK BORDES Ukuran 20 X 40 CM (D 16 mm - Ø 10 mm)				
1.000 M3	Mengecor beton K-275	1,272,600.00	1,272,600.00	
37.196 Kg	Besi Polos	9,650.00	358,939.79	
118.350 Kg	Besi Ulir	9,650.00	1,142,077.50	
1.000 M2	Memasang bekisting untuk balok	174,700.00	174,700.00	
			2,948,317.29	2,948,317.29
				2,948,300.00
HARGA 1 M3 BETON BERTULANG STRUKTUR				
SLOOF Ukuran 15 X 20 CM (Ø 12 mm - Ø 8 mm)				
1.000 M3	Mengecor beton K-275	1,272,600.00	1,272,600.00	
105.000 Kg	Besi Polos	9,650.00	1,013,250.00	
1.000 M2	Memasang bekisting untuk sloof	181,200.00	181,200.00	
			1,194,450.00	1,194,450.00
				1,194,400.00
HARGA 1 M3 BETON BERTULANG STRUKTUR				
SLOOF Ukuran 20 X 40 CM (D 16 mm - Ø 10 mm)				
1.000 M3	Mengecor beton K-275	1,272,600.00	1,272,600.00	
58.101 Kg	Besi Polos	9,650.00	560,673.04	
118.350 Kg	Besi Ulir	9,650.00	1,142,077.50	
1.000 M2	Memasang bekisting untuk sloof	181,200.00	181,200.00	
			3,156,550.54	3,156,550.54
				3,156,500.00
HARGA 1 M3 BETON BERTULANG STRUKTUR				
SLOOF Ukuran 30 X 60 CM (D 12 mm - Ø 10 mm)				
1.000 M3	Mengecor beton K-275	1,272,600.00	1,272,600.00	
13.851 Kg	Besi Polos	9,650.00	133,665.37	

	6.320 Kg	Besi Ulir		9,650.00		60,988.00		
	1.000 M2	Memasang bekisting untuk sloof		181,200.00		181,200.00		
						1,648,453.37	1,648,453.37	1,648,400.00
HARGA 1 M3 BETON BERTULANG STRUKTUR								
KOLOM Ukuran 40 X 60 CM (D 16 mm - Ø 10 mm)								
	1.000 M3	Mengecor beton K-275		1,272,600.00		1,272,600.00		
	21.176 Kg	Besi Polos		9,650.00		204,352.15		
	198.933 Kg	Besi Ulir		9,650.00		1,919,706.67		
	1.000 M2	Memasang bekisting untuk kolom		170,200.00		170,200.00		
						3,566,858.82	3,566,858.82	3,566,800.00
HARGA 1 M3 BETON BERTULANG STRUKTUR								
KOLOM Ukuran 30 X 40 CM (D 16 mm - Ø 10 mm)								
	1.000 M3	Mengecor beton K-275		1,272,600.00		1,272,600.00		
	29.186 Kg	Besi Polos		9,650.00		281,645.97		
	157.800 Kg	Besi Ulir		9,650.00		1,522,770.00		
	8.320 M2	Memasang bekisting untuk kolom		170,200.00		1,416,064.00		
						4,493,079.97	4,493,079.97	4,493,000.00
HARGA 1 M' BETON BERTULANG STRUKTUR								
Membuat 1 m' kolom praktis beton bertulang (11 x 11) cm								
Bahan								
	0.002 m3	Kayu sengon / begesting	Rp	4,000.00		8.00		
	0.010 Kg	Paku	Rp	16,000.00		160.00		
	3.000 Kg	Besi beton polos	Rp	8,000.00		24,000.00		
	0.045 Kg	Kawat beton	Rp	15,000.00		675.00		
	4.000 Kg	PC	Rp	2,000.00		8,000.00		
	0.006 m3	Pasir beton	Rp	140,000.00		840.00		
	0.009 m3	Kerikil	Rp	130,000.00		1,170.00		
Upah								
	0.180 Oh	Pekerja	Rp	65,000.00		11,700.000		
	0.020 Oh	Tukang batu	Rp	70,000.00		1,400.000		
	0.020 Oh	Tukang kayu	Rp	70,000.00		1,400.000		

0.020	Oh	Tukang besi	Rp	70,000.00		1,400.000		
0.060	Oh	Kepala tukang	Rp	75,000.00		4,500.000		
0.009	Oh	Mandor	Rp	80,000.00		720.000		
					34,853.00	21,120.000	55,973.00	55,900.00
HARGA 1 M3 BETON BERTULANG STRUKTUR								
Pile Cup 200 x 200 CM (D 19 mm - Ø 12 mm)								
1.000	M3	Mengecor beton K-275		1,272,600.00		1,272,600.00		
33.71	Kg	Besi Ulir		9,650.00		325,312.22		
78.535	Kg	Besi Polos		9,650.00		757,860.07		
1.000	M2	Memasang bekisting untuk Pondasi		181,200.00		181,200.00		
						2,536,972.29	2,536,972.29	2,536,900.00
HARGA 1 M3 BETON BERTULANG STRUKTUR								
Plat lantai tbl. 12 cm (tul. Ø 10 mm)								
1.000	M3	Mengecor beton K-275		1,272,600.00		1,272,600.00		
79.80	Kg	Besi Polos		9,650.00		770,067.22		
1.000	M2	Memasang bekisting untuk Plat Lantai		196,200.00		196,200.00		
						2,238,867.22	2,238,867.22	2,238,800.00
HARGA 1 M3 BETON BERTULANG STRUKTUR								
BALOK Latei Ukuran 11 X 20 CM (D 10 mm - Ø 6 mm)								
1.000	M3	Mengecor beton K-275		1,272,600.00		1,272,600.00		
37.000	Kg	Besi Polos		9,650.00		357,050.00		
161.455	Kg	Besi Ulir		9,650.00		1,558,036.36		
1.000	M2	Memasang bekisting untuk balok		196,200.00		196,200.00		
						3,383,886.36	3,383,886.36	3,383,800.00

ANALISA SATUAN PEKERJAAN KABUPATEN JEMBER 2017

Pekerjaan Penutup Atap

NO.	JENIS PEKERJAAN	BAHAN	UPAH	JUMLAH	BULAT
1	2	3	4	5	6
1	Analisa SNI DPU Cipta Karya dan Tata Ruang				
	1 m ² pasang atap genteng pelentong kecil				
	Bahan				
	25.000 Bh Genteng pelentong/vlampress	Rp 1,700.00		42,500.00	
	Upah				
	0.150 Oh Pekerja	Rp 65,000.00		9,750.00	
	0.075 Oh Tukang kayu	Rp 70,000.00		5,250.00	
	0.008 Oh Kepala Tukang	Rp 75,000.00		600.00	
	0.008 Oh Mandor	Rp 80,000.00		640.00	
				42,500.00	16,240.00
				58,740.00	58,700.00
2	Analisa SNI DPU Cipta Karya dan Tata Ruang				
	1 m ² pasang atap genteng kodok / glazzur				
	Bahan				
	25.000 Bh Genteng kodok	Rp 4,700.00		117,500.00	
	Upah				
	0.150 Oh Pekerja	Rp 65,000.00		9,750.00	
	0.075 Oh Tukang kayu	Rp 70,000.00		5,250.00	
	0.008 Oh Kepala Tukang	Rp 75,000.00		600.00	
	0.008 Oh Mandor	Rp 80,000.00		640.00	
				117,500.00	16,240.00
				133,740.00	133,700.00
3	Analisa SNI DPU Cipta Karya dan Tata Ruang				
	1 m ² pasang atap genteng pelentong super / besar				
	Bahan				
	12.000 Bh Genteng pelentong super	Rp 15,100.00		181,200.00	
	Upah				

	0.150 Oh Pekerja	Rp	65,000.00		9,750.00		
	0.060 Oh Tukang kayu	Rp	70,000.00		4,200.00		
	0.006 Oh Kepala Tukang	Rp	75,000.00		450.00		
	0.080 Oh Mandor	Rp	80,000.00		6,400.00		
				181,200.00	20,800.00	202,000.00	202,000.00
4	Analisa SNI DPU Cipta Karya dan Tata Ruang						
	1 m ² pasang atap lama genteng kodok / glazzur						
	Bahan						
	25.000 Bh Genteng kodok	Rp	4,700.00	117,500.00			
	Upah						
	0.150 Oh Pekerja	Rp	65,000.00		9,750.00		
	0.075 Oh Tukang kayu	Rp	70,000.00		5,250.00		
	0.008 Oh Kepala Tukang	Rp	75,000.00		600.00		
	0.008 Oh Mandor	Rp	80,000.00		640.00		
				117,500.00	16,240.00	133,740.00	133,700.00
4	Analisa SNI DPU Cipta Karya dan Tata Ruang						
	1 m' pasang atap genteng bubung pelentong						
	Bahan						
	5.000 Bh Genteng bubung pelentong	Rp	16,100.00	80,500.00			
	8.000 Kg PC	Rp	2,000.00	16,000.00			
	0.032 m ³ Pasir pasang (Pasir Kali)	Rp	140,000.00	4,480.00			
	Upah						
	0.400 Oh Pekerja	Rp	65,000.00		26,000.00		
	0.200 Oh Tukang kayu	Rp	70,000.00		14,000.00		
	0.020 Oh Kepala Tukang	Rp	75,000.00		1,500.00		
	0.002 Oh Mandor	Rp	80,000.00		160.00		
				100,980.00	41,660.00	142,640.00	142,600.00
5	Analisa SNI DPU Cipta Karya dan Tata Ruang						
	1 m' pasang bubung genteng kodok glazuur						
	Bahan						
	5.000 Bh Genteng bubung kodok	Rp	16,100.00	80,500.00			

	8.000 Kg PC	Rp	2,000.00	16,000.00			
	0.032 m ³ Pasir pasang (Pasir Kali)	Rp	140,000.00	4,480.00			
	Upah						
	0.400 Oh Pekerja	Rp	65,000.00		26,000.00		
	0.200 Oh Tukang kayu	Rp	70,000.00		14,000.00		
	0.020 Oh Kepala Tukang	Rp	75,000.00		1,500.00		
	0.002 Oh Mandor	Rp	80,000.00		160.00		
				100,980.00	41,660.00	142,640.00	142,600.00
6	Analisa SNI DPU Cipta Karya dan Tata Ruang						
	1 m' pasang bubung genteng pelentong besar						
	Bahan						
	4.000 Bh Genteng bubung pelentong besar	Rp	16,100.00	64,400.00			
	8.000 Kg PC	Rp	2,000.00	16,000.00			
	0.032 m ³ Pasir pasang (Pasir Kali)	Rp	140,000.00	4,480.00			
	Upah						
	0.400 Oh Pekerja	Rp	65,000.00		26,000.00		
	0.200 Oh Tukang kayu	Rp	70,000.00		14,000.00		
	0.020 Oh Kepala Tukang	Rp	75,000.00		1,500.00		
	0.002 Oh Mandor	Rp	80,000.00		160.00		
				84,880.00	41,660.00	126,540.00	126,500.00
7	Analisa SNI DPU Cipta Karya dan Tata Ruang						
	1 m ² pasang atap Asbes Gelombang Besar (3.00 x 1.05 m) tebal 5 mm						
	Bahan						
	0.500 Lbr Asbes gelombang	Rp	88,000.00	44,000.00			
	0.120 Kg Paku pancing 60 x 230	Rp	28,000.00	3,360.00			
	Upah						
	0.140 Oh Pekerja	Rp	65,000.00		9,100.00		
	0.075 Oh Tukang kayu	Rp	70,000.00		5,250.00		
	0.008 Oh Kepala Tukang	Rp	75,000.00		600.00		
	0.008 Oh Mandor	Rp	80,000.00		640.00		
				47,360.00	15,590.00	62,950.00	62,900.00

8	Analisa SNI DPU Cipta Karya dan Tata Ruang					
	1 m ² pasang atap Asbes Gelombang Kecil (2.40 x 1.05 m) tebal 5 mm					
	Bahan					
	0.600 Lbr Asbes gelombang	Rp	72,000.00	43,200.00		
	0.120 Kg Paku pancing 60 x 230	Rp	28,000.00	3,360.00		
	Upah					
	0.140 Oh Pekerja	Rp	65,000.00		9,100.00	
	0.075 Oh Tukang kayu	Rp	70,000.00		5,250.00	
	0.008 Oh Kepala Tukang	Rp	75,000.00		600.00	
	0.008 Oh Mandor	Rp	80,000.00		640.00	
				46,560.00	15,590.00	62,150.00
						62,100.00
9	Analisa SNI DPU Cipta Karya dan Tata Ruang					
	1 m ² pasang atap asbes gelombang (1.80 x 0.92) m x 5 mm					
	Bahan					
	0.750 Lbr Asbes gelombang	Rp	27,000.00	20,250.00		
	0.120 Kg Paku pancing 60 x 230	Rp	28,000.00	3,360.00		
	Upah					
	0.140 Oh Pekerja	Rp	65,000.00		9,100.00	
	0.070 Oh Tukang kayu	Rp	70,000.00		4,900.00	
	0.007 Oh Kepala Tukang	Rp	75,000.00		525.00	
	0.007 Oh Mandor	Rp	80,000.00		560.00	
				23,610.00	15,085.00	38,695.00
						38,600.00
10	Analisa SNI DPU Cipta Karya dan Tata Ruang					
	1 m ² pasang atap asbes gelombang (3.00 x 1.05 m) x 4 mm					
	Bahan					
	0.510 Lbr Asbes gelombang	Rp	47,000.00	23,970.00		
	0.120 Kg Paku pancing 60 x 230	Rp	28,000.00	3,360.00		
	Upah					
	0.140 Oh Pekerja	Rp	65,000.00		9,100.00	
	0.067 Oh Tukang kayu	Rp	70,000.00		4,690.00	
	0.007 Oh Kepala Tukang	Rp	75,000.00		525.00	

	0.007 Oh Mandor	Rp	80,000.00		560.00		
				27,330.00	14,875.00	42,205.00	42,200.00
11	Analisa SNI DPU Cipta Karya dan Tata Ruang						
	1 m' pasang bubung stel gelombang 0.92 m						
	Bahan						
	2.400 Lbr Bubung stel gelombang	Rp	19,500.00	46,800.00			
	6.000 Kg Paku sekrup 3.5"	Rp	55,000.00	330,000.00			
	Upah						
	0.084 Oh Pekerja	Rp	65,000.00		5,460.00		
	0.125 Oh Tukang kayu	Rp	70,000.00		8,750.00		
	0.013 Oh Kepala Tukang	Rp	75,000.00		975.00		
	0.004 Oh Mandor	Rp	80,000.00		320.00		
				376,800.00	15,505.00	392,305.00	392,300.00
12	Analisa SNI DPU Cipta Karya dan Tata Ruang						
	1 m' pasang nok stel gelombang 1.05 m						
	Bahan						
	2.100 Lbr Nok stel gelombang	Rp	13,500.00	28,350.00			
	6.000 Kg Paku sekrup 3.5"	Rp	55,000.00	330,000.00			
	Upah						
	0.084 Oh Pekerja	Rp	65,000.00		5,460.00		
	0.125 Oh Tukang kayu	Rp	70,000.00		8,750.00		
	0.013 Oh Kepala Tukang	Rp	75,000.00		975.00		
	0.004 Oh Mandor	Rp	80,000.00		320.00		
				358,350.00	15,505.00	373,855.00	373,800.00
13	Analisa SNI DPU Cipta Karya dan Tata Ruang						
	1 m' pasang nok stel gelombang 1.08 m						
	Bahan						
	2.050 Lbr Nok stel gelombang	Rp	13,500.00	27,675.00			
	6.000 Kg Paku sekrup 3.5"	Rp	55,000.00	330,000.00			
	Upah						
	0.084 Oh Pekerja	Rp	65,000.00		5,460.00		

	0.125 Oh	Tukang kayu	Rp	70,000.00		8,750.00		
	0.013 Oh	Kepala Tukang	Rp	75,000.00		975.00		
	0.004 Oh	Mandor	Rp	80,000.00		320.00		
					357,675.00	15,505.00	373,180.00	373,100.00
14	Analisa SNI DPU Cipta Karya dan Tata Ruang							
	1 m ² pasang atap genteng beton							
	Bahan							
	11.000 Bh	Genteng beton	Rp	5,500.00	60,500.00			
	0.030 Kg	Paku biasa 2" - 5"	Rp	16,000.00	480.00			
	Upah							
	0.200 Oh	Pekerja	Rp	65,000.00		13,000.00		
	0.100 Oh	Tukang kayu	Rp	70,000.00		7,000.00		
	0.010 Oh	Kepala Tukang	Rp	75,000.00		750.00		
	0.010 Oh	Mandor	Rp	80,000.00		800.00		
					60,980.00	21,550.00	82,530.00	82,500.00
15	Analisa SNI DPU Cipta Karya dan Tata Ruang							
	1 m ² pasang atap genteng metal							
	Bahan							
	1.020 Lbr	Genteng metal	Rp	95,000.00	96,900.00			
	0.200 Kg	Paku biasa 2" - 5"	Rp	16,000.00	3,200.00			
	Upah							
	0.200 Oh	Pekerja	Rp	65,000.00		13,000.00		
	0.100 Oh	Tukang kayu	Rp	70,000.00		7,000.00		
	0.010 Oh	Kepala Tukang	Rp	75,000.00		750.00		
	0.001 Oh	Mandor	Rp	80,000.00		80.00		
					100,100.00	20,830.00	120,930.00	120,900.00
14	Analisa SNI DPU Cipta Karya dan Tata Ruang							
	1 m' pasang nok genteng beton							
	Bahan							
	3.500 Bh	Nok genteng beton	Rp	9,500.00	33,250.00			
	0.050 Kg	Paku biasa 2" - 5	Rp	16,000.00	800.00			

	10.800 Kg Semen abu-abu	Rp	2,000.00	21,600.00			
	0.032 m ³ Pasir pasang (Pasir Kali)	Rp	140,000.00	4,480.00			
	1.000 Kg Semen warna	Rp	6,000.00	6,000.00			
	Upah						
	0.400 Oh Pekerja	Rp	65,000.00		26,000.00		
	0.200 Oh Tukang kayu	Rp	70,000.00		14,000.00		
	0.020 Oh Kepala Tukang	Rp	75,000.00		1,500.00		
	0.020 Oh Mandor	Rp	80,000.00		1,600.00		
				66,130.00	43,100.00	109,230.00	109,200.00
15	Analisa SNI DPU Cipta Karya dan Tata Ruang						
	1 m ² Pekerjaan Pasang Talang pembuluh pipa PVC 3" dan 4 "						
	Bahan						
	1.000 m' Pipa PVC AW dia. 3"	Rp	140,000.00	140,000.00			
	1.000 m' Pipa PVC AW dia. 4"	Rp	225,000.00	225,000.00			
	1.000 bh Klem PVC	Rp	4,000.00	4,000.00			
	0.050 bh Lem PVC	Rp	6,500.00	325.00			
	Upah						
	0.25 Oh Pekerja	Rp	65,000.00		16,250.00		
	Pekerjaan Pasang Talang pembuluh pipa PVC 3"			144,325.00	16,250.00	160,575.00	160,500.00
	Pekerjaan Pasang Talang pembuluh pipa PVC 4 "			229,325.00	16,250.00	245,575.00	245,500.00
16	Analisa SNI DPU Cipta Karya dan Tata Ruang						
	10 m' Pekerjaan pasang talang Kotak PVC						
	Bahan						
	10.000 m' Talang kotak PVC	Rp	42,500.00	425,000.00			
	11.000 bh Hak Pengantung Talang	Rp	4,000.00	44,000.00			
	2.000 bh Kemi PVC 2 "	Rp	4,500.00	9,000.00			
	2.000 bh Tutup samping talang	Rp	2,500.00	5,000.00			
	2.000 bh Lem PVC	Rp	6,500.00	13,000.00			
	1.000 m' Pipa PVC AW dia 2 "	Rp	72,000.00	72,000.00			
	0.200 Kg Paku biasa	Rp	16,000.00	3,200.00			
	2.000 bh Samb. Pipa PVC tanpa lubang	Rp	5,000.00	10,000.00			

	2.000 bh Samb. Pipa PVC ada lubang	Rp	8,000.00	16,000.00			
	Upah						
	0.1 Oh Pekerja	Rp	65,000.00		6,500.00		
	0.2 Oh Tukang kayu	Rp	70,000.00		14,000.00		
	0.02 Oh Kepala Tukang	Rp	75,000.00		1,500.00		
	0.005 Oh Mandor	Rp	80,000.00		400.00		
				597,200.00	22,400.00	619,600.00	619,600.00
	1 m' pekerjaan pasang talang kotak PVC						61,960.00
17	Analisa SNI DPU Cipta Karya dan Tata Ruang						
	1 m ² pasang aluminium foil						
	Bahan						
	0.040 roll Aluminium foil	Rp	300,000.00	12,000.00			
	0.033 roll Glasswool	Rp	200,000.00	6,666.67			
	0.111 roll Kawat Ayam	Rp	150,000.00	16,666.67			
	Upah						
	0.200 Oh Pekerja	Rp	65,000.00		13,000.00		
	0.100 Oh Tukang kayu	Rp	70,000.00		7,000.00		
	0.010 Oh Kepala Tukang	Rp	75,000.00		750.00		
	0.001 Oh Mandor	Rp	80,000.00		80.00		
				35,333.33	20,830.00	56,163.33	56,100.00
18	Analisa Sendiri						
	Atap Spandek						
	Bahan						
	1.000 m2 Atap Spandek	Rp	50,000.00	50,000.00			
	Upah						
	1.000 Ls Upah pasang	Rp	7,500.00		7,500.00		
				50,000.00	7,500.00	57,500.00	57,500.00
19	Analisa Sendiri						
	Kalsiplank l = 30cm						
	Bahan						
	1.000 m' Kalsiplank l = 30cm	Rp	12,000.00	12,000.00			

Upah						
1.000 Ls Upah pasang	Rp	1,800.00		1,800.00		
			12,000.00	1,800.00	13,800.00	13,800.00

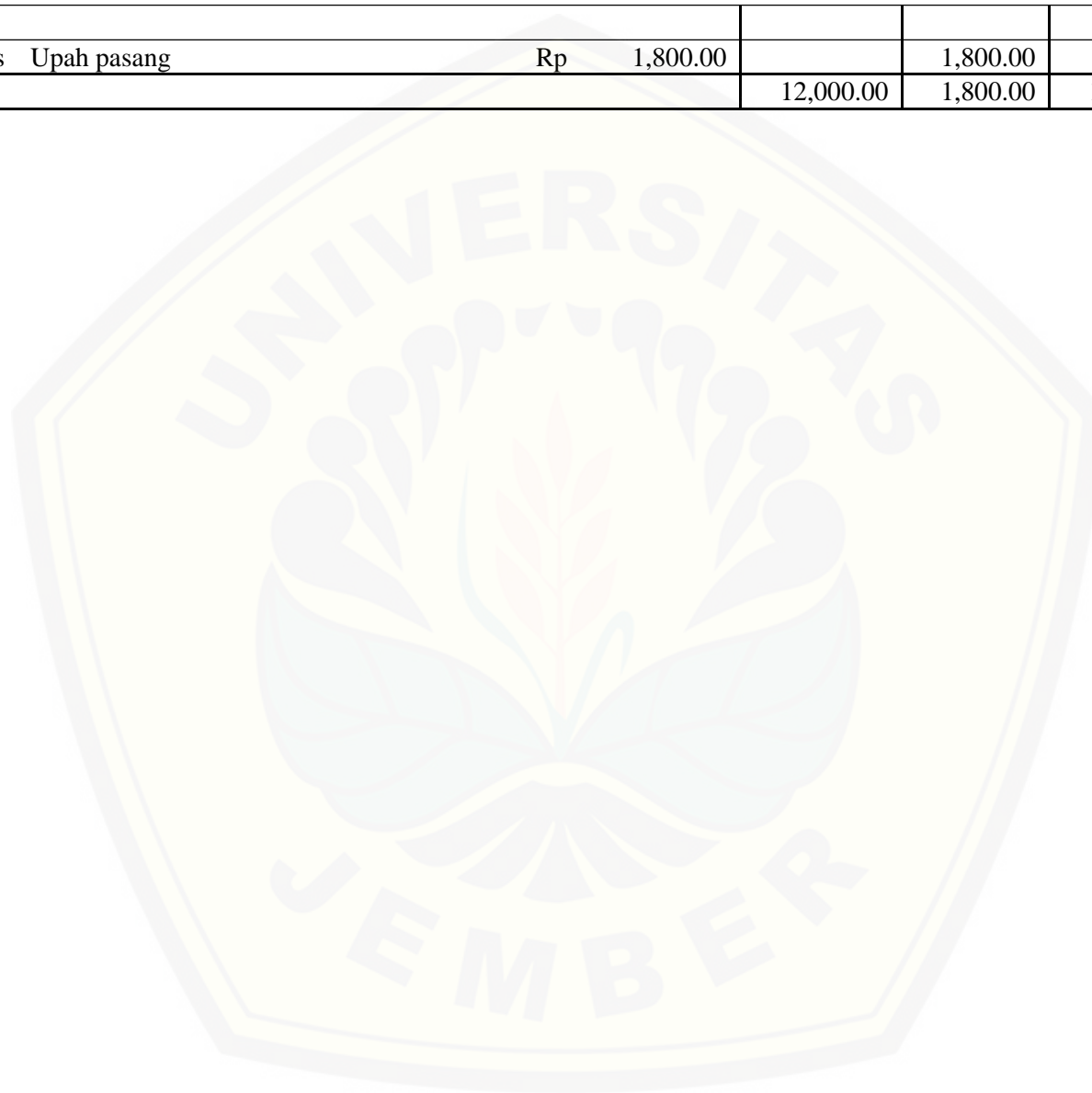

ANALISA SATUAN PEKERJAAN KABUPATEN JEMBER 2017

Pekerjaan Plafon + Partisi

NO.	JENIS PEKERJAAN	BAHAN	UPAH	JUMLAH	BULAT
1	2	3	4	5	6
	Analisa Harga Satuan PLAFON				
1	1 M2 pasang plafond (Gypsum tebal 12 mm) rangka METAL FURING				
	Bahan				
	0.375 Lmb Gypsum Tebal 12 mm	91,000.00	34,125.00		
	1.000 M2 Rangka Metal Furring	100,000.00	100,000.00		
	0.020 Kg Paku Gypsum	30,000.00	600.00		
	0.317 Kg Jointing	18,000.00	5,706.00		
	0.087 Roll Cotton Tape	24,000.00	2,088.00		
	Upah				
	0.310 Org Pekerja	65,000.00	20,150.00		
	0.800 Org Tukang Kayu	70,000.00	56,000.00		
	0.080 Org Kepala Tukang	75,000.00	6,000.00		
	0.021 Org Mandor	80,000.00	1,640.00		
	Jumlah		142,519.00	83,790.00	226,309.00
					226,300.00
2	1 M2 pasang plafond (Gypsum tebal 9 mm) rangka METAL FURING				
	Bahan				
	0.375 Lmb Gypsum Tebal 9 mm	77,000.00	28,875.00		
	1.000 M2 Rangka Metal Furring	100,000.00	100,000.00		
	0.020 Kg Paku Gypsum	30,000.00	600.00		
	0.317 Kg Jointing	18,000.00	5,706.00		
	0.087 Roll Cotton Tape	24,000.00	2,088.00		
	Upah				
	0.310 Org Pekerja	65,000.00	20,150.00		
	0.800 Org Tukang Kayu	70,000.00	56,000.00		

	0.080	Org Kepala Tukang	75,000.00		6,000.00		
	0.021	Org Mandor	80,000.00		1,640.00		
	Jumlah			137,269.00	83,790.00	221,059.00	221,000.00
3	1 M2 pasang plafond (Gypsum tebal 12 mm) rangka HOLLOW 20/40						
	Bahan						
	0.336	Lbr Gypsum Tebal 12 mm	100,000.00	33,593.12			
	0.688	Lnjr Besi galvanis hollow 20/40 4m	20,000.00	13,760.00			
	0.388	Lnjr Besi galvanis hollow 40/40 4m	28,000.00	10,864.00			
	0.043	Kg Sekrup 1 "	108,500.00	4,665.50			
	0.029	Kg Paku Cor 2"	25,000.00	715.00			
	0.560	Kg Kawat Ikat Beton	15,000.00	8,400.00			
	Upah						
	0.178	Org Pekerja	65,000.00		11,570.00		
	0.200	Org Tukang Kayu	70,000.00		14,000.00		
	0.040	Org Kepala Tukang	75,000.00		3,000.00		
	0.014	Org Mandor	80,000.00		1,080.00		
	Jumlah			71,997.62	29,650.00	101,647.62	101,600.00
4	1 M2 pasang plafond (Gypsum tebal 9 mm) rangka HOLLOW 20/40						
	Bahan						
	0.336	Lbr Gypsum Tebal 9 mm	77,000.00	25,866.70			
	0.688	Lnjr Besi galvanis hollow 20/40 4m	20,000.00	13,760.00			
	0.043	Kg Sekrup 1 "	108,500.00	4,665.50			
	0.029	Kg Paku Cor 2"	25,000.00	715.00			
	0.560	Kg Kawat Ikat Beton	15,000.00	8,400.00			
	Upah						
	0.178	Org Pekerja	65,000.00		11,570.00		
	0.200	Org Tukang Kayu	70,000.00		14,000.00		
	0.040	Org Kepala Tukang	75,000.00		3,000.00		
	0.014	Org Mandor	80,000.00		1,080.00		

	Jumlah		53,407.20	29,650.00	83,057.20	83,000.00
5	1 M2 pasang partisi (Gypsum tebal 12 mm) rangka metal stud 8cm					
	Bahan					
	1.670 m' Rangka metal stud	25,000.00	41,750.00			
	0.730 m' U runner	12,000.00	8,760.00			
	0.694 lbr Gypsum tebal 12 mm	100,000.00	69,400.00			
	0.086 kg Paku skrup	108,500.00	9,331.00			
	Upah					
	0.150 Org Pekerja	65,000.00		9,750.00		
	0.450 Org Tukang Kayu	70,000.00		31,500.00		
	0.045 Org Kepala Tukang	75,000.00		3,375.00		
	0.075 Org Mandor	80,000.00		6,000.00		
	Jumlah		129,241.00	50,625.00	179,866.00	179,800.00
6	1 M2 pasang partisi (Gypsum tebal 9 mm) rangka metal stud 8cm					
	Bahan					
	1.670 m' Rangka metal stud	25,000.00	41,750.00			
	0.730 m' U runner	12,000.00	8,760.00			
	0.694 lbr Gypsum tebal 9 mm	77,000.00	53,438.00			
	0.086 kg Paku skrup	108,500.00	9,331.00			
	Upah					
	0.150 Org Pekerja	65,000.00		9,750.00		
	0.450 Org Tukang Kayu	70,000.00		31,500.00		
	0.045 Org Kepala Tukang	75,000.00		3,375.00		
	0.075 Org Mandor	80,000.00		6,000.00		
	Jumlah		113,279.00	50,625.00	163,904.00	163,900.00
7	1 M2 pasang partisi (Gypsum tebal 12 mm) rangka hollow					
	Bahan					
	0.336 Lbr Gypsum Tebal 12 mm	100,000.00	33,593.12			

	0.894 Lnjr Besi galvanis hollow 20/40 4m	20,000.00	17,888.00			
	0.504 Lnjr Besi galvanis hollow 40/40 4m	28,000.00	14,123.20			
	0.086 Kg Sekrup 1 "	108,500.00	9,331.00			
	0.057 Kg Paku Cor 2"	25,000.00	1,430.50			
	Upah					
	0.178 Org Pekerja	65,000.00		11,570.00		
	0.200 Org Tukang Kayu	70,000.00		14,000.00		
	0.040 Org Kepala Tukang	75,000.00		3,000.00		
	0.014 Org Mandor	80,000.00		1,080.00		
	Jumlah		76,365.82	29,650.00	106,015.82	106,000.00
8	1 M2 pasang partisi (Gypsum tebal 9 mm) rangka hollow					
	Bahan					
	0.336 Lbr Gypsum Tebal 9 mm	77,000.00	25,866.70			
	0.894 Lnjr Besi galvanis hollow 20/40 4m	20,000.00	17,888.00			
	0.504 Lnjr Besi galvanis hollow 40/40 4m	28,000.00	14,123.20			
	0.086 Kg Sekrup 1 "	108,500.00	9,331.00			
	0.057 Kg Paku Cor 2"	25,000.00	1,430.50			
	Upah					
	0.178 Org Pekerja	65,000.00		11,570.00		
	0.200 Org Tukang Kayu	70,000.00		14,000.00		
	0.040 Org Kepala Tukang	75,000.00		3,000.00		
	0.014 Org Mandor	80,000.00		1,080.00		
	Jumlah		68,639.40	29,650.00	98,289.40	98,200.00
9	Analisa SNI DPU Cipta Karya dan Tata Ruang					
	Memasang 1 m2 langit-langit Kalsiboard uk. (1200 x 2400 x 6)mm					
	Bahan					
	0.347 Lbr Kalsiboard Rp	70,000.00	24,305.56			
	0.110 Kg Paku skrup Rp	108,500.00	11,935.00			
	Upah					
	0.100 Oh Pekerja Rp	65,000.00		6,500.00		

	0.050 Oh	Tukang kayu	Rp	70,000.00		3,500.00		
	0.005 Oh	Kepala Tukang	Rp	75,000.00		375.00		
	0.005 Oh	Mandor	Rp	80,000.00		400.00		
					36,240.56	10,775.00	47,015.56	47,000.00
10	Analisa SNI DPU Cipta Karya dan Tata Ruang							
	Memasang 1 m' list plafond gypsum profil							
	Bahan							
	1.050 m'	List gypsum profil	Rp	24,000.00	25,200.00			
	0.150 Kg	Tepung gypsum/semn putih	Rp	2,000.00	300.00			
	Upah							
	0.060 Oh	Pekerja	Rp	65,000.00		3,900.00		
	0.060 Oh	Tukang kayu	Rp	70,000.00		4,200.00		
	0.006 Oh	Kepala Tukang	Rp	75,000.00		450.00		
	0.003 Oh	Mandor	Rp	80,000.00		240.00		
					25,500.00	8,790.00	34,290.00	34,200.00
9	Analisa SNI DPU Cipta Karya dan Tata Ruang							
	Memasang 1 m2 langit-langit akustik uk. (60x120) cm + rangka alluminium							
	Bahan							
	3.600 m'	Profil aluminium "T"	Rp	81,000.00	291,600.00			
	0.150 Kg	Kawat diameter 4mm	Rp	3,500.00	525.00			
	1.050 Bh	Ramset	Rp	3,500.00	3,675.00			
	1.500 Lbr	Akustik (60 x 120) cm	Rp	32,000.00	48,000.00			
	Upah							
	0.500 Oh	Pekerja	Rp	65,000.00		32,500.00		
	0.500 Oh	Tukang besi	Rp	70,000.00		35,000.00		
	0.050 Oh	Kepala tukang	Rp	75,000.00		3,750.00		
	0.025 Oh	Mandor	Rp	80,000.00		2,000.00		
					291,600.00	73,250.00	364,850.00	364,800.00
11	Analisa SNI DPU Cipta Karya dan Tata Ruang							
	Memasang 1 m' list langit-langit kayu profil							
	Bahan							

	1.050 m'	List kayu profil	Rp	11,500.00	12,075.00			
	0.010 Kg	Paku	Rp	16,000.00	160.00			
	Upah							
	0.050 Oh	Pekerja	Rp	65,000.00		3,250.00		
	0.050 Oh	Tukang kayu	Rp	70,000.00		3,500.00		
	0.005 Oh	Kepala tukang	Rp	75,000.00		375.00		
	0.003 Oh	Mandor	Rp	80,000.00		240.00		
					12,235.00	7,365.00	19,600.00	19,600.00
12	Analisa SNI DPU Cipta Karya dan Tata Ruang							
	Memasang 1 m ² rangka langit-langit (50x100)cm, kayu kelas II							
	Bahan							
	0.0154 m ³	Kaso-kaso (5x7) cm	Rp	3,000,000.00	46,200.00			
	0.200 Kg	Paku 7 dan 10 cm	Rp	16,000.00	3,200.00			
	Upah							
	0.150 Oh	Pekerja	Rp	65,000.00		9,750.00		
	0.300 Oh	Tukang kayu	Rp	70,000.00		21,000.00		
	0.030 Oh	Kepala Tukang	Rp	75,000.00		2,250.00		
	0.075 Oh	Mandor	Rp	80,000.00		6,000.00		
					49,400.00	39,000.00	88,400.00	88,400.00
13	Analisa SNI DPU Cipta Karya dan Tata Ruang							
	Memasang 1 m ² langit-langit asbes semen, tebal 4mm, 5mm dan 6mm							
	Bahan							
	1.100 m ²	Asbes semen	Rp	72,000.00	79,200.00			
	0.010 Kg	Paku tripleks	Rp	16,000.00	160.00			
	Upah							
	0.030 Oh	Pekerja	Rp	65,000.00		1,950.00		
	0.070 Oh	Tukang kayu	Rp	70,000.00		4,900.00		
	0.007 Oh	Kepala Tukang	Rp	75,000.00		525.00		
	0.004 Oh	Mandor	Rp	80,000.00		320.00		
					79,200.00	7,695.00	86,895.00	86,800.00

ANALISA SATUAN PEKERJAAN KABUPATEN JEMBER 2017

Pekerjaan Sanitasi

NO.	JENIS PEKERJAAN	BAHAN	UPAH	JUMLAH	BULAT
1	2	3	4	5	6
1	Analisa SNI Dinas PU. Cipta Karya dan Tata Ruang				
	Memasang 1 buah KLOSET DUDUK / monoblok lengkap Setara KIA				
	Bahan				
	1.000 Bh Kloset duduk/monoblok Rp 370,000.00	370,000.00			
	Upah				
	3.300 Oh Pekerja Rp 65,000.00		214,500.00		
	1.100 Oh Tukang batu Rp 70,000.00		77,000.00		
	0.001 Oh Kepala Tukang Rp 75,000.00		75.00		
	0.160 Oh Mandor Rp 80,000.00		12,800.00		
		370,000.00	304,375.00	674,375.00	674,300.00
1a	Analisa SNI Dinas PU. Cipta Karya dan Tata Ruang				
	Memasang 1 buah KLOSET DUDUK / monoblok lengkap Setara America Standart				
	Bahan				
	1.000 Bh Kloset duduk/monoblok Rp 485,000.00	485,000.00			
	Upah				
	3.300 Oh Pekerja Rp 65,000.00		214,500.00		
	1.100 Oh Tukang batu Rp 70,000.00		77,000.00		
	0.001 Oh Kepala Tukang Rp 75,000.00		75.00		
	0.160 Oh Mandor Rp 80,000.00		12,800.00		
		485,000.00	304,375.00	789,375.00	789,300.00
2	Analisa SNI Dinas PU. Cipta Karya dan Tata Ruang				
	Memasang 1 buah Kloset Jongkok porselen Setara KIA				
	Bahan				
	1.000 Bh Kloset jongkok porselen Rp 135,000.00	135,000.00			

	6.000 Kg PC	Rp	2,000.00	12,000.00			
	0.010 m ³ Pasir pasang (Pasir Kali)	Rp	140,000.00	1,400.00			
	Upah						
	1.000 Oh Pekerja	Rp	65,000.00		65,000.00		
	1.500 Oh Tukang batu	Rp	70,000.00		105,000.00		
	1.500 Oh Kepala Tukang	Rp	75,000.00		112,500.00		
	0.160 Oh Mandor	Rp	80,000.00		12,800.00		
				148,400.00	295,300.00	443,700.00	443,700.00
3	Analisa SNI Dinas PU. Cipta Karya dan Tata Ruang						
	Memasang 1 buah Urinoir						
	Bahan						
	1.000 Bh Urinoir setara ina	Rp	1,503,900.00	1,503,900.00			
	1.000 set Perlengkapan	Rp	375,975.00	375,975.00			
	6.000 Kg PC	Rp	2,000.00	12,000.00			
	0.010 m ³ Pasir pasang (Pasir Kali)	Rp	140,000.00	1,400.00			
	Upah						
	1.000 Oh Pekerja	Rp	65,000.00		65,000.00		
	1.000 Oh Tukang batu	Rp	70,000.00		70,000.00		
	0.100 Oh Kepala Tukang	Rp	75,000.00		7,500.00		
	0.100 Oh Mandor	Rp	80,000.00		8,000.00		
				1,893,275.00	150,500.00	2,043,775.00	2,043,700.00
4	Analisa SNI Dinas PU. Cipta Karya dan Tata Ruang						
	Memasang 1 buah wastafel						
	Bahan						
	1.000 Bh Wastafel	Rp	200,000.00	200,000.00			
	6.000 Kg Semen abu-abu	Rp	6,000.00	36,000.00			
	0.010 m ³ Pasir pasang (Pasir Kali)	Rp	140,000.00	1,400.00			
	Upah						
	1.200 Oh Pekerja	Rp	65,000.00		78,000.00		
	1.450 Oh Tukang batu	Rp	70,000.00		101,500.00		
	0.150 Oh Kepala Tukang	Rp	75,000.00		11,250.00		
	0.100 Oh Mandor	Rp	80,000.00		8,000.00		

				237,400.00	198,750.00	436,150.00	436,100.00
5	Analisa SNI Dinas PU. Cipta Karya dan Tata Ruang						
	Memasang 1 buah Bak Kontrol pasangan batu bata ukuran (30 x 30) cm, tinggi 35cm						
	Bahan						
	84.000 bh Batu bata	Rp	400.00	33,600.00			
	44.000 Kg PC	Rp	2,000.00	88,000.00			
	0.070 m ³ Pasir pasang (Pasir Kali)	Rp	140,000.00	9,800.00			
	0.070 m ³ Batu kerikil	Rp	130,000.00	9,100.00			
	1.600 Kg Besi beton	Rp	8,000.00	12,800.00			
	0.060 m ³ Pasir beton (Pasir Kali)	Rp	140,000.00	8,400.00			
	Upah						
	3.200 Oh Pekerja	Rp	65,000.00		208,000.00		
	1.015 Oh Tukang batu	Rp	70,000.00		71,050.00		
	0.0015 Oh Kepala Tukang	Rp	75,000.00		112.50		
	0.016 Oh Mandor	Rp	80,000.00		1,280.00		
				161,700.00	280,442.50	442,142.50	442,100.00
6	Analisa SNI Dinas PU. Cipta Karya dan Tata Ruang						
	Memasang 1 buah Bak Kontrol pasangan batu bata ukuran (45 x 45) cm, tinggi 50cm						
	Bahan						
	145.000 bh Batu bata	Rp	400.00	58,000.00			
	77.000 Kg PC	Rp	2,000.00	154,000.00			
	0.130 m ³ Pasir pasang (Pasir Kali)	Rp	140,000.00	18,200.00			
	0.020 m ³ Batu kerikil	Rp	130,000.00	2,600.00			
	2.600 Kg Besi beton	Rp	8,000.00	20,800.00			
	0.090 m ³ Pasir beton (Pasir Kali)	Rp	140,000.00	12,600.00			
	Upah						
	1.420 Oh Pekerja	Rp	65,000.00		92,300.00		
	0.473 Oh Tukang batu	Rp	70,000.00		33,110.00		
	0.047 Oh Kepala Tukang	Rp	75,000.00		3,525.00		
	0.071 Oh Mandor	Rp	80,000.00		5,680.00		
				266,200.00	134,615.00	400,815.00	400,800.00
7	Analisa SNI Dinas PU. Cipta Karya dan Tata Ruang						

	Memasang 1 buah bak kontrol pasangan batu bata ukuran (60 x 60) cm, tinggi 50cm							
	Bahan							
	212.000 bh	Batu bata	Rp	400.00	84,800.00			
	114.000 Kg	PC	Rp	2,000.00	228,000.00			
	0.184 m ³	Pasir pasang (Pasir Kali)	Rp	140,000.00	25,760.00			
	0.033 m ³	Batu koral	Rp	130,000.00	4,290.00			
	4.850 Kg	Besi beton	Rp	8,000.00	38,800.00			
	0.120 m ³	Pasir beton (Pasir Kali)	Rp	140,000.00	16,800.00			
	Upah							
	2.160 Oh	Pekerja	Rp	65,000.00	140,400.00			
	0.720 Oh	Tukang batu	Rp	70,000.00	50,400.00			
	0.072 Oh	Kepala Tukang	Rp	75,000.00	5,400.00			
	0.108 Oh	Mandor	Rp	80,000.00	8,640.00			
	0.100 Oh	Tukang gali	Rp	65,000.00	6,500.00			
					398,450.00	211,340.00	609,790.00	609,700.00
8	Analisa SNI Dinas PU. Cipta Karya dan Tata Ruang							
	Memasang 1 m' pipa PVC tipe AW diameter ½"							
	Bahan							
	1.000 m'	Pipa PVC	Rp	17,500.00	17,500.00			
	1.000 set	Perlengkapan	Rp	6,125.00	6,125.00			
	Upah							
	0.036 Oh	Pekerja	Rp	65,000.00	2,340.00			
	0.060 Oh	Tukang batu	Rp	70,000.00	4,200.00			
	0.006 Oh	Kepala Tukang	Rp	75,000.00	450.00			
	0.0018 Oh	Mandor	Rp	80,000.00	144.00			
					23,625.00	7,134.00	30,759.00	30,700.00
9	Analisa SNI Dinas PU. Cipta Karya dan Tata Ruang							
	Memasang 1 m' pipa PVC tipe AW diameter ¾"							
	Bahan							
	1.000 m'	Pipa PVC	Rp	23,000.00	23,000.00			
	1.000 set	Perlengkapan	Rp	8,050.00	8,050.00			
	Upah							

	0.036 Oh Pekerja	Rp	65,000.00		2,340.00		
	0.060 Oh Tukang batu	Rp	70,000.00		4,200.00		
	0.006 Oh Kepala Tukang	Rp	75,000.00		450.00		
	0.0018 Oh Mandor	Rp	80,000.00		144.00		
				31,050.00	7,134.00	38,184.00	38,100.00
10	Analisa SNI Dinas PU. Cipta Karya dan Tata Ruang						
	Memasang 1 m' pipa PVC tipe AW diameter 1"						
	Bahan						
	1.200 m' Pipa PVC	Rp	32,000.00	38,400.00			
	1.000 set Perlengkapan	Rp	11,200.00	11,200.00			
	Upah						
	0.036 Oh Pekerja	Rp	65,000.00		2,340.00		
	0.060 Oh Tukang batu	Rp	70,000.00		4,200.00		
	0.006 Oh Kepala Tukang	Rp	75,000.00		450.00		
	0.0018 Oh Mandor	Rp	80,000.00		144.00		
				49,600.00	7,134.00	56,734.00	56,700.00
11	Analisa SNI Dinas PU. Cipta Karya dan Tata Ruang						
	Memasang 1 m' pipa PVC tipe AW diameter 1½"						
	Bahan						
	1.200 m' Pipa PVC	Rp	57,500.00	69,000.00			
	1.000 set Perlengkapan	Rp	20,125.00	20,125.00			
	Upah						
	0.036 Oh Pekerja	Rp	65,000.00		2,340.00		
	0.060 Oh Tukang batu	Rp	70,000.00		4,200.00		
	0.006 Oh Kepala Tukang	Rp	75,000.00		450.00		
	0.0018 Oh Mandor	Rp	80,000.00		144.00		
				89,125.00	7,134.00	96,259.00	96,200.00
12	Analisa SNI Dinas PU. Cipta Karya dan Tata Ruang						
	Memasang 1 m' pipa PVC tipe AW diameter 2"						
	Bahan						
	1.200 m' Pipa PVC	Rp	72,000.00	86,400.00			
	1.000 set Perlengkapan	Rp	25,200.00	25,200.00			
	Upah						

	0.054 Oh Pekerja	Rp	65,000.00		3,510.00		
	0.090 Oh Tukang batu	Rp	70,000.00		6,300.00		
	0.009 Oh Kepala Tukang	Rp	75,000.00		675.00		
	0.0027 Oh Mandor	Rp	80,000.00		216.00		
				111,600.00	10,701.00	122,301.00	122,300.00
13	Analisa SNI Dinas PU. Cipta Karya dan Tata Ruang						
	Memasang 1 m' pipa PVC tipe AW diameter 2½"						
	Bahan						
	1.200 m' Pipa PVC	Rp	105,000.00	126,000.00			
	1.000 set Perlengkapan	Rp	36,750.00	36,750.00			
	Upah						
	0.036 Oh Pekerja	Rp	65,000.00		2,340.00		
	0.060 Oh Tukang batu	Rp	70,000.00		4,200.00		
	0.006 Oh Kepala Tukang	Rp	75,000.00		450.00		
	0.0018 Oh Mandor	Rp	80,000.00		144.00		
				162,750.00	7,134.00	169,884.00	169,800.00
14	Analisa SNI Dinas PU. Cipta Karya dan Tata Ruang						
	Memasang 1 m' pipa PVC tipe AW diameter 3"						
	Bahan						
	1.200 m' Pipa PVC	Rp	140,000.00	168,000.00			
	1.000 set Perlengkapan	Rp	49,000.00	49,000.00			
	Upah						
	0.081 Oh Pekerja	Rp	65,000.00		5,265.00		
	0.135 Oh Tukang batu	Rp	70,000.00		9,450.00		
	0.0135 Oh Kepala Tukang	Rp	75,000.00		1,012.50		
	0.0041 Oh Mandor	Rp	80,000.00		328.00		
				217,000.00	16,055.50	233,055.50	233,000.00
15	Analisa SNI Dinas PU. Cipta Karya dan Tata Ruang						
	Memasang 1 m' pipa PVC tipe AW diameter 4"						
	Bahan						
	1.200 m' Pipa PVC	Rp	225,000.00	270,000.00			
	1.000 set Perlengkapan	Rp	78,750.00	78,750.00			
	Upah						

	0.081 Oh Pekerja	Rp	65,000.00		5,265.00		
	0.135 Oh Tukang batu	Rp	70,000.00		9,450.00		
	0.0135 Oh Kepala Tukang	Rp	75,000.00		1,012.50		
	0.0041 Oh Mandor	Rp	80,000.00		328.00		
				348,750.00	16,055.50	364,805.50	364,800.00
16	Analisa SNI Dinas PU. Cipta Karya dan Tata Ruang						
	Memasang 1 buah kran diameter ¾" atau ½"						
	Bahan						
	1.000 Bh Kran air	Rp	24,000.00	24,000.00			
	0.025 Bh Seal tape	Rp	3,500.00	87.50			
	Upah						
	0.010 Oh Pekerja	Rp	65,000.00		650.00		
	0.100 Oh Tukang batu	Rp	70,000.00		7,000.00		
	0.010 Oh Kepala Tukang	Rp	75,000.00		750.00		
	0.005 Oh Mandor	Rp	80,000.00		400.00		
				24,087.50	8,800.00	32,887.50	32,800.00
17	Analisa SNI Dinas PU. Cipta Karya dan Tata Ruang						
	Memasang 1 buah <i>floor drain</i>						
	Bahan						
	1.000 Bh <i>Floor drain</i>	Rp	74,600.00	74,600.00			
	Upah						
	0.010 Oh Pekerja	Rp	65,000.00		650.00		
	0.100 Oh Tukang batu	Rp	70,000.00		7,000.00		
	0.010 Oh Kepala Tukang	Rp	75,000.00		750.00		
	0.005 Oh Mandor	Rp	80,000.00		400.00		
				74,600.00	8,800.00	83,400.00	83,400.00
18	Analisa SNI Dinas PU. Cipta Karya dan Tata Ruang						
	Memasang 1 m' Pipa GI Ø 4"						
	Bahan						
	1.200 m' Pipa GI Ø 4"	Rp	550,000.00	660,000.00			
	1.000 set Perlengkapan	Rp	55,000.00	55,000.00			
	Upah						
	0.135 Oh Pekerja	Rp	65,000.00		8,775.00		

	0.2250 Oh	Tukang batu	Rp	70,000.00		15,750.00		
	0.0225 Oh	Kepala Tukang	Rp	75,000.00		1,687.50		
	0.0070 Oh	Mandor	Rp	80,000.00		560.00		
					715,000.00	26,772.50	741,772.50	741,700.00
19	Analisa SNI Dinas PU. Cipta Karya dan Tata Ruang							
	Memasang 1 m' Pipa GI Ø 3"							
	Bahan							
	1.200 m'	Pipa GI Ø 3"	Rp	330,000.00	396,000.00			
	1.000 set	Perlengkapan	Rp	33,000.00	33,000.00			
	Upah							
	0.108 Oh	Pekerja	Rp	65,000.00		7,020.00		
	0.1800 Oh	Tukang batu	Rp	70,000.00		12,600.00		
	0.0180 Oh	Kepala Tukang	Rp	75,000.00		1,350.00		
	0.0050 Oh	Mandor	Rp	80,000.00		400.00		
					429,000.00	21,370.00	450,370.00	450,300.00
20	Analisa SNI Dinas PU. Cipta Karya dan Tata Ruang							
	Memasang 1 m' Pipa GI Ø 1.5"							
	Bahan							
	1.200 m'	Pipa GI Ø 1.5"	Rp	87,500.00	105,000.00			
	1.000 set	Perlengkapan	Rp	8,750.00	8,750.00			
	Upah							
	0.108 Oh	Pekerja	Rp	65,000.00		7,020.00		
	0.1800 Oh	Tukang batu	Rp	70,000.00		12,600.00		
	0.0180 Oh	Kepala Tukang	Rp	75,000.00		1,350.00		
	0.0050 Oh	Mandor	Rp	80,000.00		400.00		
					113,750.00	21,370.00	135,120.00	135,100.00
21	Analisa SNI Dinas PU. Cipta Karya dan Tata Ruang							
	Memasang 1 m' Pipa GI Ø 1"							
	Bahan							
	1.200 m'	Pipa GI Ø 1"	Rp	50,900.00	61,080.00			
	1.000 set	Perlengkapan	Rp	5,090.00	5,090.00			
	Upah							
	0.108 Oh	Pekerja	Rp	65,000.00		7,020.00		

	0.1800 Oh	Tukang batu	Rp	70,000.00		12,600.00		
	0.0180 Oh	Kepala Tukang	Rp	75,000.00		1,350.00		
	0.0050 Oh	Mandor	Rp	80,000.00		400.00		
					66,170.00	21,370.00	87,540.00	87,500.00
22	Analisa SNI Dinas PU. Cipta Karya dan Tata Ruang							
	Membuat 1 Unit Septictank Uk. 200 x 100 x 125 cm							
	Bahan dan Upah							
	4.000 m ³	Galian tanah	Rp	62,100.00	248,400.00			
	16.833 m ²	Pas. Bata merah 1:5	Rp	82,100.00	1,382,016.67			
	13.650 m ²	Plesteran 1:3	Rp	51,000.00	696,150.00			
	0.210 m ³	Plat beton bertulang	Rp	18,880,600.00	3,964,926.00			
	8.000 m'	Pipa PVC AW 4 "	Rp	54,400.00	435,200.00			
	2.000 m'	Pipa Hawa PVC AW 2 "	Rp	95,583.33	191,166.67			
					6,917,859.33	-	6,917,859.33	6,917,800.00
23	Analisa SNI Dinas PU. Cipta Karya dan Tata Ruang							
	Membuat 1 bh Sumur Resapan diameter 80 cm (rong), tinggi 2,5 m							
	Bahan dan Upah							
	6.750 m ³	Galian tanah	Rp	62,100.00	419,175.00			
	12.750 m ²	Pas. Bata merah 1:5	Rp	82,100.00	1,046,775.00			
	1.300 m ³	Urugan Pasir	Rp	106,700.00	138,710.00			
	1.300 m ³	Urugan Sirtu	Rp	96,200.00	125,060.00			
	0.140 m ³	Plat beton bertulang	Rp	18,880,600.00	2,643,284.00			
	4.000 m'	Pipa PVC AW dia 3 "	Rp	140,000.00	560,000.00			
	2.000 m'	Pipa Hawa PVC AW 2 "	Rp	72,000.00	144,000.00			
					5,077,004.00	-	5,077,004.00	5,077,000.00
24	Analisa SNI Dinas PU. Cipta Karya dan Tata Ruang							
	1 M' Pemasangan Saluran terbuka Buis Beton U 20 cm							
	Bahan dan Upah							
	0.420 m ³	Galian tanah	Rp	62,100.00	26,082.00			
	0.060 m ³	Urugan pasir	Rp	106,700.00	6,402.00			
	1.200 m ²	Pas.Bt.merah 1:6	Rp	79,900.00	95,880.00			

	1.000 m'	Buis beton U 20 cm	Rp	78,000.00	78,000.00			
	1.000 m ²	Plesteran 1:3	Rp	51,000.00	51,000.00			
	4.000 m'	Benangan 1:2	Rp	15,100.00	60,400.00			
					317,764.00	-	317,764.00	317,700.00



ANALISA SATUAN PEKERJAAN KABUPATEN JEMBER 2017

Pekerjaan Besi dan Aluminium

NO.	JENIS PEKERJAAN	BAHAN	UPAH	JUMLAH	BULAT
1	2	3	4	5	6
1	Analisa SNI DPU Cipta Karya dan Tata Ruang				
	Memasang 1 Kg besi profil				
	Bahan				
	1.150 Kg Besi profil Rp 8,000.00	9,200.00			
	Upah				
	0.060 Oh Pekerja Rp 65,000.00		3,900.00		
	0.060 Oh Tukang las konstruk Rp 70,000.00		4,200.00		
	0.006 Oh Kepala Tukang Rp 75,000.00		450.00		
	0.003 Oh Mandor Rp 80,000.00		240.00		
		9,200.00	8,790.00	17,990.00	17,900.00
2	Analisa SNI DPU Cipta Karya dan Tata Ruang				
	Membuat 1 m2 pintu besi plat baja tebal 2mm rangkap, rangka besi hollow				
	Bahan				
	4.200 m' Besi Hollow 40x40 Rp 28,000.00	117,600.00			
	6.900 m' Besi Hollow 20x40 Rp 20,000.00	138,000.00			
	6.900 Kg Besi plat baja Rp 6,500.00	44,850.00			
	1.000 ls Aksesoris Pintu Rp 61,592.25	61,592.25			
	0.500 Kg Kawat las Rp 26,000.00	13,000.00			
	0.480 Kg Meni besi Rp 22,000.00	10,560.00			
	0.520 Kg Cat besi Rp 70,000.00	36,400.00			
	0.240 Ltr Minyak Cat Rp 4,000.00	960.00			
	Upah				
	2.000 Oh Pekerja Rp 65,000.00		130,000.00		
	2.000 Oh Tukang las biasa Rp 70,000.00		140,000.00		
	0.200 Oh Kepala Tukang Rp 75,000.00		15,000.00		

	0.100 Oh	Mandor	Rp	80,000.00		8,000.00		
					422,962.25	293,000.00	715,962.25	715,900.00
3	Analisa SNI DPU Cipta Karya dan Tata Ruang							
	Membuat 1 m2 Pagar Besi Hollow 40x40, 20x40							
	Bahan							
	2.767 m'	Besi Hollow 40x40	Rp	28,000.00	77,476.00			
	11.898 m'	Besi Hollow 20x40	Rp	20,000.00	237,960.00			
	0.200 Kg	Kawat las	Rp	26,000.00	5,200.00			
	0.240 Kg	Meni besi	Rp	22,000.00	5,280.00			
	0.520 Kg	Cat besi	Rp	70,000.00	36,400.00			
	0.120 Ltr	Minyak Cat	Rp	4,000.00	480.00			
	Upah							
	2.000 Oh	Pekerja	Rp	65,000.00		130,000.00		
	2.000 Oh	Tukang las biasa	Rp	70,000.00		140,000.00		
	0.200 Oh	Kepala Tukang	Rp	75,000.00		15,000.00		
	0.100 Oh	Mandor	Rp	80,000.00		8,000.00		
					362,796.00	293,000.00	655,796.00	655,700.00
2	Analisa SNI DPU Cipta Karya dan Tata Ruang							
	Memasang 1 Kg rangka kuda-kuda baja IWF							
	Bahan							
	1.150 Kg	Besi baja IWF	Rp	7,000.00	8,050.00			
	Upah							
	0.060 Oh	Pekerja	Rp	65,000.00		3,900.00		
	0.060 Oh	Tukang las konstruk	Rp	70,000.00		4,200.00		
	0.006 Oh	Kepala Tukang	Rp	75,000.00		450.00		
	0.003 Oh	Mandor	Rp	80,000.00		240.00		
					8,050.00	8,790.00	16,840.00	16,800.00
10	Analisa SNI DPU Cipta Karya dan Tata Ruang							
	Memasang 1 m kusen pintu aluminium							
	Bahan							
	1.100 m	Profil aluminium	Rp	82,500.00	90,750.00			

	2.000 Bh	Skrup fixer	Rp	39,800.00	79,600.00			
	0.060	Tube Sealant	Rp	1,184,700.00	71,082.00			
	Upah							
	0.043 Oh	Pekerja	Rp	65,000.00		2,795.00		
	0.043 Oh	Tukang khusus alur	Rp	63,250.00		2,719.75		
	0.0043 Oh	Kepala Tukang	Rp	75,000.00		322.50		
	0.0021 Oh	Mandor	Rp	80,000.00		168.00		
					241,432.00	6,005.25	247,437.25	247,400.00
11	Analisa SNI DPU Cipta Karya dan Tata Ruang							
	Memasang 1 m2 pintu aluminium strip lebar 8 cm							
	Bahan							
	4.400 m'	Profil aluminium	Rp	82,500.00	363,000.00			
	14.600 m'	Alluminium strip	Rp	#REF!	#REF!			
	Upah							
	0.085 Oh	Pekerja	Rp	65,000.00		5,525.00		
	0.085 Oh	Tukang khusus alur	Rp	63,250.00		5,376.25		
	0.0085 Oh	Kepala Tukang	Rp	75,000.00		637.50		
	0.0042 Oh	Mandor	Rp	80,000.00		336.00		
					363,000.00	11,874.75		
12	Analisa SNI DPU Cipta Karya dan Tata Ruang							
	Memasang 1 m2 pintu kaca rangka aluminium							
	Bahan							
	4.400 m'	Pintu alluminium	Rp	#REF!	#REF!			
	4.500 m'	Kaca Rayben 5mm l	Rp	#REF!	#REF!			
	0.270	Tube Sealant	Rp	1,184,700.00	319,869.00			
	Upah							
	0.085 Oh	Pekerja	Rp	65,000.00		5,525.00		
	0.085 Oh	Tukang khusus alur	Rp	63,250.00		5,376.25		
	0.009 Oh	Kepala Tukang	Rp	75,000.00		675.00		
	0.005 Oh	Mandor	Rp	80,000.00		400.00		
					#REF!	11,976.25	#REF!	#REF!

13	Analisa SNI DPU Cipta Karya dan Tata Ruang					
	Memasang 1 m2 <i>venetion blinds</i> dan <i>vertical blinds</i>					
	Bahan					
	venetion blinds dan vertical blinds					
	1.000 m2 (tirai)	Rp	#REF!	#REF!		
	Upah					
	0.350 Oh Pekerja	Rp	65,000.00		22,750.00	
	0.350 Oh Tukang	Rp	63,250.00		22,137.50	
	0.035 Oh Kepala Tukang	Rp	75,000.00		2,625.00	
	0.018 Oh Mandor	Rp	80,000.00		1,440.00	
				#REF!	48,952.50	
14	Analisa SNI DPU Cipta Karya dan Tata Ruang					
	Memasang 1 m2 terali besi strip (2 x 3) mm					
	Bahan					
	6.177 Kg Besi strip	Rp	3,300.00	20,384.10		
	27.080 cm Pengelasan	Rp	#REF!	#REF!		
	Upah					
	1.670 Oh Pekerja	Rp	65,000.00		108,550.00	
	1.670 Oh Tukang	Rp	63,250.00		105,627.50	
	0.167 Oh Kepala Tukang	Rp	75,000.00		12,525.00	
	0.083 Oh Mandor	Rp	80,000.00		6,640.00	
				#REF!	233,342.50	
1	Analisa Sendiri					
	Memasang 1 unit Kusen Pintu Temperd 12 mm P1					
	Bahan					
	1.800 m' Kusen aluminium 4'	Rp	81,000.00	145,800.00		
	1.000 m2 Kaca Temperd 12 m	Rp	485,000.00	485,000.00		
	1.000 m1 Karet sponing	Rp	2,500.00	2,500.00		
	1.000 Tube Sealant	Rp	48,200.00	48,200.00		
	1.000 ps Engsel Pintu	Rp	30,000.00	30,000.00		

	1.000 bh	Handle Pintu	Rp	200,000.00	200,000.00			
	1.000 bh	Kunci pintu	Rp	110,000.00	110,000.00			
	0.100	Upah 10 % dari harga bah.	Rp	1,021,500.00		102,150.00		
					1,021,500.00	102,150.00	1,123,650.00	1,123,600.00
2	Analisa Sendiri							
	Memasang 1 Unit Kusén Pintu-Jendela Type PJ 1							
	Bahan							
	15.780 m'	Kusén alumunium	Rp	81,000.00	1,278,180.00			
	4.543 m2	Kaca polos 5 mm	Rp	125,000.00	567,900.00			
	22.320 m'	Karet sponing	Rp	2,500.00	55,800.00			
	2.660 m2	Daun Pintu Lapis pl.	Rp	552,200.00	1,468,852.00			
	3.000 ps	Engsel pintu	Rp	30,000.00	90,000.00			
	2.000 ps	Engsel jendela	Rp	16,000.00	32,000.00			
	1.000 bh	Handel pintu	Rp	100,000.00	100,000.00			
	1.000 bh	Kunci pintu 2 x puta	Rp	110,000.00	110,000.00			
	1.000 Bh	Grendel tanam pintu	Rp	60,000.00	60,000.00			
	1.000 Bh	Grendel jendela	Rp	7,000.00	7,000.00			
	2.000 bh	Hak angin maju-mui	Rp	3,000.00	6,000.00			
	1.000	Tube Sealant	Rp	48,200.00	48,200.00			
	0.100	Upah 10 % dari harga bah.	Rp	3,823,932.00		382,393.20		
					3,823,932.00	382,393.20	4,206,325.20	4,206,300.00
	Analisa Sendiri							
	Memasang 1 Unit Kusén Pintu Type P 1							
	Bahan							
	4.680 m'	Kusén alumunium	Rp	81,000.00	379,080.00			
	0.070 m2	Kaca polos 5 mm	Rp	125,000.00	8,800.00			
	1.000 m'	Karet sponing	Rp	2,500.00	2,500.00			
	1.520 m2	Daun Pintu Lapis pl.	Rp	552,200.00	839,344.00			
	1.000 ps	Engsel pintu	Rp	30,000.00	30,000.00			
	1.000 ps	Handel pintu	Rp	100,000.00	100,000.00			
	1.000 bh	Kunci pintu 2 x puta	Rp	110,000.00	110,000.00			

	0.100 Upah 10 % dari harga bah. Rp	1,469,724.00		146,972.40		
			1,469,724.00	146,972.40	1,616,696.40	1,616,600.00
	Analisa Sendiri					
	Memasang 1 Unit Kusen Pintu Type P 3					
	Bahan					
	5.360 m' Kusen alumunium Rp	81,000.00		434,160.00		
	0.141 m2 Kaca polos 5 mm Rp	125,000.00		17,600.00		
	2.660 m2 Daun Pintu Lapis pl: Rp	552,200.00		1,468,852.00		
	1.000 ps Engsel pintu Rp	30,000.00		30,000.00		
	1.000 ps Handel pintu Rp	100,000.00		100,000.00		
	1.000 bh Kunci pintu 2 x puta Rp	110,000.00		110,000.00		
	0.100 Upah 10 % dari harga bah. Rp	2,160,612.00		216,061.20		
			2,160,612.00	216,061.20	2,376,673.20	2,376,600.00
	Analisa Sendiri					
	Memasang 1 Unit Kusen Jendela Type J1					
	Bahan					
	11.480 m' Kusen aluminium 4' Rp	81,000.00		929,880.00		
	2.384 m2 Kaca Polos 5 mm Rp	125,000.00		298,050.00		
	14.120 m' Karet sponing Rp	2,500.00		35,300.00		
	1.000 Tube Sealant Rp	48,200.00		48,200.00		
	4.000 ps Engsel Jendela Rp	16,000.00		64,000.00		
	4.000 bh Hak angin maju mur Rp	3,000.00		12,000.00		
	0.100 Upah 10 % dari harga bah. Rp	1,387,430.00		138,743.00		
			1,387,430.00	138,743.00	1,526,173.00	1,526,100.00
	Analisa Sendiri					
	Memasang 1 Unit Kusen Jendela Type BV 1					
	Bahan					
	1.760 m' Kusen aluminium 4' Rp	81,000.00		142,560.00		
	0.260 m2 Kaca Polos 5 mm Rp	125,000.00		32,550.00		
	2.000 m' Karet sponing Rp	2,500.00		5,000.00		
	0.500 Tube Sealant Rp	48,200.00		24,100.00		

	0.100 Upah 10 % dari harga bah.Rp	204,210.00		20,421.00		
			204,210.00	20,421.00	224,631.00	224,600.00
	Analisa Sendiri					
	Memasang 1 Unit Kusen Jendela Type BV 2					
	Bahan					
	2.360 m' Kusen aluminium 4' Rp	81,000.00	191,160.00			
	0.384 m2 Kaca Polos 5 mm Rp	125,000.00	48,050.00			
	2.400 m' Karet sponing Rp	2,500.00	6,000.00			
	0.500 Tube Sealant Rp	48,200.00	24,100.00			
	0.100 Upah 10 % dari harga bah.Rp	269,310.00		26,931.00		
			269,310.00	26,931.00	296,241.00	296,200.00
	Analisa Sendiri					
	Memasang 1 Unit Kusen Pintu Shaft					
	Bahan					
	3.520 m' Kusen aluminium 4' Rp	81,000.00	285,120.00			
	0.840 m2 Daun Pintu Lapis pl.Rp	552,200.00	463,848.00			
	2.000 bh Engsel pintu Rp	30,000.00	60,000.00			
	1.000 bh Kunci pintu 1 x puta Rp	100,000.00	100,000.00			
	0.100 Upah 10 % dari harga bah.Rp	908,968.00		90,896.80		
			908,968.00	90,896.80	999,864.80	999,800.00
	Analisa Sendiri					
	Memasang 1 Unit Partisi Type PR 1					
	Bahan					
	6.000 m' Kusen aluminium 4' Rp	81,000.00	486,000.00			
	1.269 m2 Gypsumboard 9 mm Rp	77,000.00	97,697.60			
	6.960 m' Karet sponing Rp	2,500.00	17,400.00			
	2.592 m2 Pengecatan tembok Rp	19,600.00	50,803.20			
	0.100 Upah 10 % dari harga bah.Rp	651,900.80		65,190.08		
			651,900.80	65,190.08	717,090.88	717,000.00
	Analisa Sendiri					
	Memasang 1 Unit Partisi Type PR 2					

	Bahan						
	9.960 m'	Kusen aluminium 4' Rp	81,000.00	806,760.00			
	1.269 m2	Gypsumboard 9 mm Rp	77,000.00	97,697.60			
	6.960 m'	Karet sponing Rp	2,500.00	17,400.00			
	2.592 m2	Pengecatan tembok Rp	19,600.00	50,803.20			
	0.100 Upah 10 % dari harga bah. Rp		972,660.80		97,266.08		
				972,660.80	97,266.08	1,069,926.88	1,069,900.00
	Analisa Sendiri						
	Memasang 1 Unit Partisi Type PR 3						
	Bahan						
	10.000 m'	Kusen aluminium 4' Rp	81,000.00	810,000.00			
	2.294 m2	Gypsumboard 9 mm Rp	77,000.00	176,607.20			
	6.000 m'	Karet sponing Rp	2,500.00	15,000.00			
	2.160 m2	Pengecatan tembok Rp	19,600.00	42,336.00			
	0.100 Upah 10 % dari harga bah. Rp		1,043,943.20		104,394.32		
				1,043,943.20	104,394.32	1,148,337.52	1,148,300.00
	Analisa Sendiri						
	Memasang 1 Unit Partisi Type PR 4						
	Bahan						
	10.200 m'	Kusen aluminium 4' Rp	81,000.00	826,200.00			
	2.416 m2	Gypsumboard 9 mm Rp	77,000.00	186,001.20			
	6.200 m'	Karet sponing Rp	2,500.00	15,500.00			
	2.280 m2	Pengecatan tembok Rp	19,600.00	44,688.00			
	0.100 Upah 10 % dari harga bah. Rp		1,072,389.20		107,238.92		
				1,072,389.20	107,238.92	1,179,628.12	1,179,600.00
	Analisa Sendiri						
	Memasang 1 Unit Partisi Type PR 5						
	Bahan						
	3.660 m'	Kusen aluminium 4' Rp	81,000.00	296,460.00			
	1.391 m2	Gypsumboard 9 mm Rp	77,000.00	107,091.60			
	3.500 m'	Karet sponing Rp	2,500.00	8,750.00			

	1.320 m2	Pengecatan tembok Rp	19,600.00	25,872.00			
	0.100	Upah 10 % dari harga bah.Rp	438,173.60		43,817.36		
				438,173.60	43,817.36	481,990.96	481,900.00
	Analisa Sendiri						
	Memasang 1 Unit Partisi Type PR 6						
	Bahan						
	22.070 m'	Kusen aluminium 4' Rp	81,000.00	1,787,670.00			
	10.653 m2	Gypsumboard 9 mm Rp	77,000.00	820,265.60			
	42.780 m'	Karet sponing Rp	2,500.00	106,950.00			
	10.653 m2	Pengecatan tembok Rp	19,600.00	208,794.88			
	0.100	Upah 10 % dari harga bah.Rp	2,923,680.48		292,368.05		
				2,923,680.48	292,368.05	3,216,048.53	3,216,000.00
	Analisa Sendiri						
	Memasang 1 Unit Partisi Type PR 7						
	Bahan						
	10.740 m'	Kusen aluminium 4' Rp	81,000.00	869,940.00			
	13.800 m2	Gypsumboard 9 mm Rp	77,000.00	1,062,600.00			
	32.360 m'	Karet sponing Rp	2,500.00	80,900.00			
	13.800 m2	Pengecatan tembok Rp	19,600.00	270,480.00			
	0.100	Upah 10 % dari harga bah.Rp	2,283,920.00		228,392.00		
				2,283,920.00	228,392.00	2,512,312.00	2,512,300.00
	Analisa Sendiri						
	Memasang 1 Unit Partisi Type PR 8						
	Bahan						
	90.240 m'	Kusen aluminium 4' Rp	81,000.00	7,309,440.00			
	64.860 m2	Gypsumboard 9 mm Rp	77,000.00	4,994,220.00			
	150.620 m'	Karet sponing Rp	2,500.00	376,550.00			
	64.860 m2	Pengecatan tembok Rp	19,600.00	1,271,256.00			
	0.100	Upah 10 % dari harga bah.Rp	13,951,466.00		1,395,146.60		
				13,951,466.00	1,395,146.60	15,346,612.60	15,346,600.00
	Analisa Sendiri						

	Memasang 1 Unit Partisi Type PR 9						
	Bahan						
	33.910 m'	Kusen aluminium 4' Rp	81,000.00	2,746,710.00			
	20.719 m2	Gypsumboard 9 mm Rp	77,000.00	1,595,378.40			
	47.830 m'	Karet sponing Rp	2,500.00	119,575.00			
	20.719 m2	Pengecatan tembok Rp	19,600.00	406,096.32			
	0.100	Upah 10 % dari harga bah. Rp	4,867,759.72		486,775.97		
				4,867,759.72	486,775.97	5,354,535.69	5,354,500.00
	Analisa Sendiri						
	Memasang 1 Unit Partisi Type PR 9'						
	Bahan						
	32.210 m'	Kusen aluminium 4' Rp	81,000.00	2,609,010.00			
	19.201 m2	Gypsumboard 9 mm Rp	77,000.00	1,478,492.40			
	49.560 m'	Karet sponing Rp	2,500.00	123,900.00			
	19.201 m2	Pengecatan tembok Rp	19,600.00	376,343.52			
	0.100	Upah 10 % dari harga bah. Rp	4,587,745.92		458,774.59		
				4,587,745.92	458,774.59	5,046,520.51	5,046,500.00
	Analisa Sendiri						
	Memasang 1 Unit Partisi Type PR 10						
	Bahan						
	35.670 m'	Kusen aluminium 4' Rp	81,000.00	2,889,270.00			
	29.140 m2	Gypsumboard 9 mm Rp	77,000.00	2,243,780.00			
	52.240 m'	Karet sponing Rp	2,500.00	130,600.00			
	29.140 m2	Pengecatan tembok Rp	19,600.00	571,144.00			
	0.100	Upah 10 % dari harga bah. Rp	5,834,794.00		583,479.40		
				5,834,794.00	583,479.40	6,418,273.40	6,418,200.00
	Analisa Sendiri						
	Memasang 1 Unit Partisi Type PR 11						
	Bahan						
	199.075 kg	Besi C. 150.50.20.3, Rp.	13,800.00	2,747,239.60			
	20.645 kg	Penggantung besi L. Rp.	8,000.00	165,158.40			

	29.140 m2	Gypsumboard 9 mm Rp.	77,000.00	2,243,780.00			
	19.992 m2	Daun Pintu Panel ka Rp.	507,200.00	10,139,942.40			
	0.010 m3	Stoper Kayu Klas II Rp.	5,000,000.00	50,600.00			
	42.000 m2	Engsel pintu Rp.	30,000.00	1,260,000.00			
	2.000 bh	Kunci pintu 2 x puta Rp.	110,000.00	220,000.00			
	4.000 bh	Handel pintu Rp.	100,000.00	400,000.00			
	28.000 Set	Grendel pintu Rp.	7,000.00	196,000.00			
	2.000 Set	Rel Pintu gantung W Rp.	942,000.00	1,884,000.00			
	27.824 m2	Cat tembok Rp.	19,600.00	545,350.40			
	39.984 m2	Plituran Rp.	49,700.00	1,987,204.80			
	0.100 Upah 10 % dari harga bah.	Rp.	21,839,275.60		2,183,927.56		
				21,839,275.60	2,183,927.56	24,023,203.16	24,023,200.00
	Analisa Sendiri						
	Memasang 1 M2 Relling Tangga						
	Bahan						
	8.600 m'	Pipa stenles steel Ø Rp	190,000.00	1,634,000.00			
	12.960 m'	Pipa stenles steel Ø Rp	160,000.00	2,073,600.00			
	12.960 m'	Pipa stenles steel Ø Rp	12,500.00	162,000.00			
	0.100 Upah 10 % dari harga bah.	Rp.	3,869,600.00		386,960.00		
				3,869,600.00	386,960.00	4,256,560.00	4,256,500.00
6	Analisa Sendiri						
	Memasang 1 unit Kusen Pintu p2						
	Bahan						
	5.200 m'	Kusen aluminium 4' Rp	81,000.00	421,200.00			
	0.280 m2	Kaca Polos 5 mm Rp	125,000.00	35,000.00			
	m1	Karet sponing Rp	2,500.00	-			
	1.680 m2	Pintu Triplek Lapis Rp	399,000.00	670,320.00			
	1.500 ps	Engsel Pintu Rp	30,000.00	45,000.00			
	1.000 bh	Handle Pintu Rp	100,000.00	100,000.00			
	1.000 bh	Kunci pintu Rp	110,000.00	110,000.00			
	0.100 Upah 10 % dari harga bah.	Rp	1,381,520.00		138,152.00		

				1,381,520.00	138,152.00	1,519,672.00	1,519,600.00
7	Analisa Sendiri						
	Memasang 1 unit Kusen Jendela J1 kaca Aluminium 4"						
	Bahan						
	47.500 m' Kusen aluminium 4' Rp	81,000.00		3,847,500.00			
	7.000 m2 Kaca Polos 5 mm Rp	125,000.00		875,000.00			
	95.000 m1 Karet sponing Rp	2,500.00		237,500.00			
	1.000 Tube Sealant Rp	48,200.00		48,200.00			
	6.000 ps Engsel Jendela Rp	16,000.00		96,000.00			
	6.000 bh Hak angin maju mur Rp	3,000.00		18,000.00			
	0.000 bh Kunci pintu Rp	110,000.00		-			
	0.100 Upah 10 % dari harga bah. Rp	3,609,840.00			360,984.00		
				5,122,200.00	360,984.00	5,483,184.00	5,483,100.00
8	Analisa Sendiri						
	Memasang 1 unit Kusen Jendela J1 kaca Aluminium 4"						
	Bahan						
	4.600 m' Kusen aluminium 4' Rp	81,000.00		372,600.00			
	1.050 m2 Kaca Polos 5 mm Rp	125,000.00		131,250.00			
	9.200 m1 Karet sponing Rp	2,500.00		23,000.00			
	1.000 Tube Sealant Rp	48,200.00		48,200.00			
	0.000 ps Engsel Jendela Rp	16,000.00		-			
	0.000 bh Hak angin maju mur Rp	3,000.00		-			
	0.000 bh Kunci pintu Rp	110,000.00		-			
	0.100 Upah 10 % dari harga bah. Rp	3,609,840.00			360,984.00		
				575,050.00	360,984.00	936,034.00	936,000.00
9	Analisa Sendiri						
	Memasang 1 unit Kusen Pintu P0 kaca Aluminium 4"						
	Bahan						
	29.990 m' Kusen aluminium 4' Rp	81,000.00		2,429,190.00			
	5.460 m2 Kaca Polos 5 mm Rp	125,000.00		682,500.00			
	59.980 m1 Karet sponing Rp	2,500.00		149,950.00			

	1.000 Tube Sealant	Rp	48,200.00	48,200.00			
	3.000 ps Engsel Pintu	Rp	30,000.00	90,000.00			
	1.000 bh Handle Pintu	Rp	100,000.00	100,000.00			
	1.000 bh Kunci pintu	Rp	110,000.00	110,000.00			
	0.100 Upah 10 % dari harga bah.	Rp	3,609,840.00		360,984.00		
				3,609,840.00	360,984.00	3,970,824.00	3,970,800.00
10	Analisa Sendiri						
	Memasang 1 m2 Rangka Plapon metal furing uk.20.40.1.4 mm						
	Bahan						
	3.400 m' metal furring	Rp	100,000.00	340,000.00			
	3.000 m' Kawat ramset	Rp	3,500.00	10,500.00			
	0.100 Upah dan alat bantu 10 %	Rp	350,500.00		35,050.00		
				350,500.00	35,050.00	385,550.00	385,500.00
28	Analisa SNI DPU Cipta Karya dan Tata Ruang						
	Memasang 1 m2 kawat nyamuk						
11	Analisa SNI DPU Cipta Karya dan Tata Ruang						
	Memasang 1 m2 jendela nako dan tralis						
	Bahan						
	1.100 m2 Jendela nako (rangk.	Rp	35,000.00	38,500.00			
	10.000 Bh Paku skrup 1 - 2.5cn	Rp	55,000.00	550,000.00			
	7.000 m' Besi strip	Rp	3,300.00	23,100.00			
	Upah						
	0.200 Oh Pekerja	Rp	65,000.00		13,000.00		
	0.200 Oh Tukang	Rp	70,000.00		14,000.00		
	0.020 Oh Kepala Tukang	Rp	75,000.00		1,500.00		
	0.001 Oh Mandor	Rp	80,000.00		80.00		
				611,600.00	28,580.00	640,180.00	640,100.00
12	Analisa SNI DPU Cipta Karya dan Tata Ruang						
	Memasang 1 m' talang datar/jurai seng BJLS 28 lebar 90cm						
	Bahan						
	1.050 m' Seng plat	Rp	60,000.00	63,000.00			

	0.015 Kg	Paku 1 - 2.5cm	Rp	13,500.00	202.50			
	0.019 m ³	Papan kayu kelas II	Rp	6,000,000.00	114,000.00			
	Upah							
	0.200 Oh	Pekerja	Rp	65,000.00		13,000.00		
	0.400 Oh	Tukang	Rp	70,000.00		28,000.00		
	0.025 Oh	Kepala Tukang	Rp	75,000.00		1,875.00		
	0.010 Oh	Mandor	Rp	80,000.00		800.00		
					177,202.50	43,675.00	220,877.50	220,800.00
13	Analisa SNI DPU Cipta Karya dan Tata Ruang							
	Memasang 1 m' talang ½ lingkaran D-15cm, seng plat BJLS 30 lebar 45cm							
	Bahan							
	1.050 m'	Seng plat	Rp	60,000.00	63,000.00			
	0.010 Kg	Paku 1 - 2.5cm	Rp	13,500.00	135.00			
	0.500 Kg	Besi strip	Rp	3,300.00	1,650.00			
	Upah							
	0.150 Oh	Pekerja	Rp	65,000.00		9,750.00		
	0.300 Oh	Tukang	Rp	70,000.00		21,000.00		
	0.030 Oh	Kepala Tukang	Rp	75,000.00		2,250.00		
	0.008 Oh	Mandor	Rp	80,000.00		640.00		
					64,785.00	33,640.00	98,425.00	98,400.00

**ANALISA SATUAN PEKERJAAN
KABUPATEN JEMBER 2017**

Pekerjaan Lantai

NO.	JENIS PEKERJAAN	BAHAN	UPAH	JUMLAH	BULAT	
1	2	3	4	5	6	
1	LANTAI GRANIT					
	Analisa SNI DPU Cipta Karya dan Tata Ruang					
	Memasang 1 m2 Lantai Granit Uk. 60 x 60 cm					
	Bahan					
	2.778 Bh Granit uk. 60 x 60 cm Rp 26,000.00	72,228.00				
	10.000 Kg PC Rp 2,000.00	20,000.00				
	0.045 m ³ Pasir pasang (Pasir Kali) Rp 140,000.00	6,300.00				
	1.500 Kg Semen warna Rp 6,000.00	9,000.00				
	Upah					
	0.900 Oh Pekerja Rp 65,000.00		58,500.00			
	0.450 Oh Tukang Rp 70,000.00		31,500.00			
	0.045 Oh Kepala Tukang Rp 75,000.00		3,375.00			
	0.045 Oh Mandor Rp 80,000.00		3,600.00			
			107,528.00	96,975.00	204,503.00	204,500.00
	2	Analisa SNI DPU Cipta Karya dan Tata Ruang				
Memasang 1 m2 Lantai Granit Uk. 40 x 40 cm						
Bahan						
6.630 Bh Granit uk. 40 x 40 cm Rp 25,000.00		165,750.00				
9.800 Kg PC Rp 2,000.00		19,600.00				
0.045 m ³ Pasir pasang (Pasir Kali) Rp 140,000.00		6,300.00				
1.300 Kg Semen warna Rp 6,000.00		7,800.00				
Upah						
0.260 Oh Pekerja Rp 65,000.00			16,900.00			
0.130 Oh Tukang Rp 70,000.00			9,100.00			
0.013 Oh Kepala Tukang Rp 75,000.00			975.00			

	0.013 Oh Mandor	Rp	80,000.00		1,040.00		
				199,450.00	28,015.00	227,465.00	227,400.00
3	LANTAI KERAMIK Setara ROMAN						
	Analisa SNI DPU Cipta Karya dan Tata Ruang						
	Memasang 1 m ² lantai keramik uk 60 x 60 cm						
	Bahan						
	2.778 Bh	Keramik uk 60 x 60 cm	Rp	8,000.00	22,224.00		
	10.000 Kg	PC	Rp	2,000.00	20,000.00		
	0.045 m ³	Pasir pasang (Pasir Kali)	Rp	140,000.00	6,300.00		
	1.500 Kg	Semen warna	Rp	6,000.00	9,000.00		
	Upah						
	0.900 Oh	Pekerja	Rp	65,000.00		58,500.00	
	0.450 Oh	Tukang	Rp	70,000.00		31,500.00	
	0.045 Oh	Kepala Tukang	Rp	75,000.00		3,375.00	
	0.045 Oh	Mandor	Rp	80,000.00		3,600.00	
				57,524.00	96,975.00	154,499.00	154,400.00
4	Analisa SNI DPU Cipta Karya dan Tata Ruang						
	Memasang 1 m ² lantai keramik uk 40 x 40 cm						
	Bahan						
	6.630 Bh	Keramik uk 40 x 40 cm	Rp	12,000.00	79,560.00		
	9.800 Kg	PC	Rp	2,000.00	19,600.00		
	0.045 m ³	Pasir pasang (Pasir Kali)	Rp	140,000.00	6,300.00		
	1.300 Kg	Semen warna	Rp	6,000.00	7,800.00		
	Upah						
	0.260 Oh	Pekerja	Rp	65,000.00		16,900.00	
	0.130 Oh	Tukang	Rp	70,000.00		9,100.00	
	0.013 Oh	Kepala Tukang	Rp	75,000.00		975.00	
	0.013 Oh	Mandor	Rp	80,000.00		1,040.00	
				113,260.00	28,015.00	141,275.00	141,200.00
5	Analisa SNI DPU Cipta Karya dan Tata Ruang						
	Memasang 1 m ² lantai keramik 30 x 30 cm						

	Bahan						
	11.870 Bh Ubin keramik	Rp	7,000.00	83,090.00			
	10.000 Kg PC	Rp	2,000.00	20,000.00			
	0.045 m ³ Pasir pasang (Pasir Kali)	Rp	140,000.00	6,300.00			
	1.500 Kg Semen warna	Rp	6,000.00	9,000.00			
	Upah						
	0.700 Oh Pekerja	Rp	65,000.00		45,500.00		
	0.350 Oh Tukang	Rp	70,000.00		24,500.00		
	0.035 Oh Kepala Tukang	Rp	75,000.00		2,625.00		
	0.035 Oh Mandor	Rp	80,000.00		2,800.00		
				118,390.00	75,425.00	193,815.00	193,800.00
	Analisa SNI DPU Cipta Karya dan Tata Ruang						
	Memasang 1 m ² lantai keramik kasar 30 x 30 cm						
	Bahan						
	11.870 Bh Ubin keramik kasar	Rp	8,000.00	94,960.00			
	10.000 Kg PC	Rp	2,000.00	20,000.00			
	0.045 m ³ Pasir pasang (Pasir Kali)	Rp	140,000.00	6,300.00			
	1.500 Kg Semen warna	Rp	6,000.00	9,000.00			
	Upah						
	0.700 Oh Pekerja	Rp	65,000.00		45,500.00		
	0.350 Oh Tukang	Rp	70,000.00		24,500.00		
	0.035 Oh Kepala Tukang	Rp	75,000.00		2,625.00		
	0.035 Oh Mandor	Rp	80,000.00		2,800.00		
				130,260.00	75,425.00	205,685.00	205,600.00
	DINDING KERAMIK Setara ROMAN						
6	Analisa SNI DPU Cipta Karya dan Tata Ruang						
	Memasang 1 m ² Dinding Keramik uk 25 x 40 cm						
	Bahan						
	10.000 Bh Keramik	Rp	13,000.00	130,000.00			
	9.300 Kg PC	Rp	2,000.00	18,600.00			
	0.018 m ³ Pasir pasang (Pasir Kali)	Rp	140,000.00	2,520.00			

	1.940 Kg Semen warna	Rp	6,000.00	11,640.00			
	Upah						
	0.900 Oh Pekerja	Rp	65,000.00		58,500.00		
	0.450 Oh Tukang	Rp	70,000.00		31,500.00		
	0.045 Oh Kepala Tukang	Rp	75,000.00		3,375.00		
	0.045 Oh Mandor	Rp	80,000.00		3,600.00		
				162,760.00	96,975.00	259,735.00	259,700.00
7	Analisa SNI DPU Cipta Karya dan Tata Ruang						
	Memasang 1 m ² lantai parquet kayu						
	Bahan						
	1.050 m ² Parquet	Rp	160,000.00	168,000.00			
	0.600 Kg Lem	Rp	11,500.00	6,900.00			
	Upah						
	0.700 Oh Pekerja	Rp	65,000.00		45,500.00		
	0.350 Oh Tukang	Rp	70,000.00		24,500.00		
	0.035 Oh Kepala Tukang	Rp	75,000.00		2,625.00		
	0.035 Oh Mandor	Rp	80,000.00		2,800.00		
				174,900.00	75,425.00	250,325.00	250,300.00
8	Analisa SNI DPU Cipta Karya dan Tata Ruang						
	Memasang 1 m ² conblock paving abu-abu tebal 6cm (K-175)						
	Bahan						
	1.000 m ² Paving stone abu-abu	Rp	85,000.00	85,000.00			
	0.050 m ³ Galian tanah	Rp	50,700.00	2,535.00			
	0.050 m ³ Pasir urug	Rp	72,000.00	3,600.00			
	Upah						
	0.360 Oh Pekerja	Rp	65,000.00		23,400.00		
	0.120 Oh Tukang	Rp	70,000.00		8,400.00		
	0.012 Oh Kepala Tukang	Rp	75,000.00		900.00		
	0.018 Oh Mandor	Rp	80,000.00		1,440.00		
				91,135.00	34,140.00	125,275.00	125,200.00
9	Analisa SNI DPU Cipta Karya dan Tata Ruang						

	Memasang 1 m² conblock paving abu-abu tebal 6cm (K-250)							
	Bahan							
	1.000 m ²	Paving stone abu-abu	Rp	64,500.00	64,500.00			
	0.050 m ³	Galian tanah	Rp	50,700.00	2,535.00			
	0.050 m ³	Pasir urug	Rp	72,000.00	3,600.00			
	Upah							
	0.360 Oh	Pekerja	Rp	65,000.00		23,400.00		
	0.120 Oh	Tukang	Rp	70,000.00		8,400.00		
	0.012 Oh	Kepala Tukang	Rp	75,000.00		900.00		
	0.018 Oh	Mandor	Rp	80,000.00		1,440.00		
					70,635.00	34,140.00	104,775.00	104,700.00
9	Analisa SNI DPU Cipta Karya dan Tata Ruang							
	Memasang 1 m² conblock paving abu-abu tebal 6cm (K-300)							
	Bahan							
	1.000 m ²	Paving stone abu-abu	Rp	74,800.00	74,800.00			
	0.050 m ³	Galian tanah	Rp	50,700.00	2,535.00			
	0.050 m ³	Pasir urug	Rp	72,000.00	3,600.00			
	Upah							
	0.360 Oh	Pekerja	Rp	65,000.00		23,400.00		
	0.120 Oh	Tukang	Rp	70,000.00		8,400.00		
	0.012 Oh	Kepala Tukang	Rp	75,000.00		900.00		
	0.018 Oh	Mandor	Rp	80,000.00		1,440.00		
					80,935.00	34,140.00	115,075.00	115,000.00
10	Analisa SNI DPU Cipta Karya dan Tata Ruang							
	Memasang 1 m² conblock paving abu-abu tebal 8cm (K-175)							
	Bahan							
	1.000 m ²	Paving stone abu-abu	Rp	95,000.00	95,000.00			
	0.050 m ³	Galian tanah	Rp	50,700.00	2,535.00			
	0.050 m ³	Pasir urug	Rp	72,000.00	3,600.00			

	Upah						
	0.360 Oh Pekerja	Rp	65,000.00		23,400.00		
	0.120 Oh Tukang	Rp	70,000.00		8,400.00		
	0.012 Oh Kepala Tukang	Rp	75,000.00		900.00		
	0.018 Oh Mandor	Rp	80,000.00		1,440.00		
				101,135.00	34,140.00	135,275.00	135,200.00
11	Analisa SNI DPU Cipta Karya dan Tata Ruang						
	Memasang 1 m ² conblock paving abu-abu tebal 8cm (K-250)						
	Bahan						
	1.000 m ² Paving stone abu-abu	Rp	95,000.00	95,000.00			
	0.050 m ³ Galian tanah	Rp	50,700.00	2,535.00			
	0.050 m ³ Pasir urug	Rp	72,000.00	3,600.00			
	Upah						
	0.360 Oh Pekerja	Rp	65,000.00		23,400.00		
	0.120 Oh Tukang	Rp	70,000.00		8,400.00		
	0.012 Oh Kepala Tukang	Rp	75,000.00		900.00		
	0.018 Oh Mandor	Rp	80,000.00		1,440.00		
				101,135.00	34,140.00	135,275.00	135,200.00
11	Analisa SNI DPU Cipta Karya dan Tata Ruang						
	Memasang 1 m ² conblock paving abu-abu tebal 8cm (K-300)						
	Bahan						
	1.000 m ² Paving stone abu-abu	Rp	99,800.00	99,800.00			
	0.050 m ³ Galian tanah	Rp	50,700.00	2,535.00			
	0.050 m ³ Pasir urug	Rp	72,000.00	3,600.00			
	Upah						
	0.360 Oh Pekerja	Rp	50,700.00		18,252.00		
	0.120 Oh Tukang	Rp	72,000.00		8,640.00		
	0.012 Oh Kepala Tukang	Rp	75,000.00		900.00		
	0.018 Oh Mandor	Rp	65,000.00		1,170.00		
				105,935.00	28,962.00	134,897.00	134,800.00

12	Analisa SNI DPU Cipta Karya dan Tata Ruang					
	Memasang 1 m Kanstin beton 15x30x40					
	Bahan					
	2.500 m ² Kanstin beton 15x30x40	Rp	49,000.00	122,500.00		
	0.050 m ³ Galian tanah	Rp	50,700.00	2,535.00		
	0.050 m ³ Pasir urug	Rp	72,000.00	3,600.00		
	Upah					
	0.360 Oh Pekerja	Rp	65,000.00		23,400.00	
	0.120 Oh Tukang	Rp	70,000.00		8,400.00	
	0.012 Oh Kepala Tukang	Rp	75,000.00		900.00	
	0.018 Oh Mandor	Rp	80,000.00		1,440.00	
				128,635.00	34,140.00	162,775.00
						162,700.00
13	Analisa SNI DPU Cipta Karya dan Tata Ruang					
	Memasang 1 m ² Lantai batu alam Uk. 40 x 60 cm					
	Bahan					
	1.079 m ² Lantai batu alam	Rp	120,000.00	129,480.00		
	10.000 Kg PC	Rp	2,000.00	20,000.00		
	0.045 m ³ Pasir pasang (Pasir Kali)	Rp	140,000.00	6,300.00		
	1.500 Kg Semen warna	Rp	6,000.00	9,000.00		
	Upah					
	0.620 Oh Pekerja	Rp	65,000.00		40,300.00	
	0.350 Oh Tukang	Rp	70,000.00		24,500.00	
	0.035 Oh Kepala Tukang	Rp	75,000.00		2,625.00	
	0.030 Oh Mandor	Rp	80,000.00		2,400.00	
				164,780.00	69,825.00	234,605.00
						234,600.00

ANALISA SATUAN PEKERJAAN
KABUPATEN JEMBER 2017

Pekerjaan Pengecatan

NO.	JENIS PEKERJAAN	BAHAN	UPAH	JUMLAH	BULAT
1	2	3	4	5	6
1	Analisa SNI DPU Cipta Karya dan Tata Ruang				
	Mengikis/mengerok 1 m ² permukaan cat tembok lama				
	Upah				
	0.150 Oh Pekerja Rp 65,000.00		9,750.00		
	0.000 Oh Tukang Rp 70,000.00				
	0.000 Oh Kepala Tukang Rp 75,000.00		-		
	0.0025 Oh Mandor Rp 80,000.00		200.00		
		-	9,950.00	9,950.00	9,900.00
2	Analisa SNI DPU Cipta Karya dan Tata Ruang				
	Mengecat 1 m ² bidang kayu lama				
	Bahan				
	0.150 Kg Plamir Rp 7,000.00	1,050.00			
	0.170 Kg Cat dasar Rp 35,000.00	5,950.00			
	0.170 Kg Cat penutup Rp 35,000.00	5,950.00			
	Upah				
	0.070 Oh Pekerja Rp 65,000.00		4,550.00		
	0.075 Oh Tukang Rp 70,000.00		5,250.00		
	0.0075 Oh Kepala Tukang Rp 75,000.00		562.50		
	0.0025 Oh Mandor Rp 80,000.00		200.00		
		12,950.00	10,562.50	23,512.50	23,500.00
3	Analisa SNI DPU Cipta Karya dan Tata Ruang				
	1 m ² Pengecatan bidang kayu baru (1 lapis plamir, 1 lapis cat dasar, 2 lapis cat penutup)				
	Bahan				
	0.200 Kg Meni kayu Rp 22,000.00	4,400.00			
	0.150 Kg Plamir kayu Rp 7,000.00	1,050.00			

	0.170 Kg Cat dasar	Rp	35,000.00	5,950.00			
	0.260 Kg Cat penutup 2x	Rp	35,000.00	9,100.00			
	Upah						
	0.070 Oh Pekerja	Rp	65,000.00		4,550.00		
	0.009 Oh Tukang Cat	Rp	70,000.00		630.00		
	0.006 Oh Kepala Tukang	Rp	75,000.00		450.00		
	0.0025 Oh Mandor	Rp	80,000.00		200.00		
				20,500.00	5,830.00	26,330.00	26,300.00
4	Analisa SNI DPU Cipta Karya dan Tata Ruang						
	1 m ² Pengecatan bidang kayu baru (1 lapis plamir, 1 lapis cat dasar, 3 lapis cat penutup)						
	Bahan						
	0.200 Kg Meni kayu	Rp	22,000.00	4,400.00			
	0.150 Kg Plamir kayu	Rp	7,000.00	1,050.00			
	0.170 Kg Cat dasar	Rp	35,000.00	5,950.00			
	0.350 Kg Cat penutup 3x	Rp	35,000.00	12,250.00			
	Upah						
	0.070 Oh Pekerja	Rp	65,000.00		4,550.00		
	0.105 Oh Tukang Cat	Rp	70,000.00		7,350.00		
	0.004 Oh Kepala Tukang	Rp	75,000.00		300.00		
	0.0025 Oh Mandor	Rp	80,000.00		200.00		
				23,650.00	12,400.00	36,050.00	36,000.00
5	Analisa SNI DPU Cipta Karya dan Tata Ruang						
	1 m ² Pelaburan bidang kayu dengan teak oil						
	Bahan						
	0.360 Ltr Teak oil	Rp	4,000.00	1,440.00			
	Upah						
	0.040 Oh Pekerja	Rp	65,000.00		2,600.00		
	0.063 Oh Tukang Cat	Rp	70,000.00		4,410.00		
	0.063 Oh Kepala Tukang	Rp	75,000.00		4,725.00		
	0.0025 Oh Mandor	Rp	80,000.00		200.00		
				1,440.00	11,935.00	13,375.00	13,300.00

6	Analisa SNI DPU Cipta Karya dan Tata Ruang					
	1 m ² Pelaburan bidang kayu dengan politur					
	Bahan					
	0.150 Ltr Politur	Rp 55,000.00	8,250.00			
	0.372 Ltr Politur jadi	Rp 75,000.00	27,900.00			
	2.000 Lbr Ampelas	Rp 4,000.00	8,000.00			
	Upah					
	0.000 Oh Pekerja	Rp 65,000.00	-			
	0.060 Oh Tukang Cat	Rp 70,000.00	4,200.00			
	0.016 Oh Kepala Tukang	Rp 75,000.00	1,200.00			
	0.0025 Oh Mandor	Rp 80,000.00	200.00			
			44,150.00	5,600.00	49,750.00	49,700.00
7	Analisa SNI DPU Cipta Karya dan Tata Ruang					
	1 m ² Pengecatan Tembok baru (1 lapis plamir, 1 lapis cat dasar, 2 lapis cat penutup)					
	Catilac INTERIOR					
	Bahan					
	0.100 Kg Plamir tembok	Rp 7,000.00	700.00			
	0.100 Kg Cat dasar	Rp 35,000.00	3,500.00			
	0.260 Kg Cat penutup 2x	Rp 35,000.00	9,100.00			
	Upah					
	0.020 Oh Pekerja	Rp 65,000.00	1,300.00			
	0.063 Oh Tukang Cat	Rp 70,000.00	4,410.00			
	0.0063 Oh Kepala Tukang	Rp 75,000.00	472.50			
	0.0025 Oh Mandor	Rp 80,000.00	200.00			
			13,300.00	6,382.50	19,682.50	19,600.00
8	Analisa Universitas					
	1 m ² Pengecatan Tembok baru EXTERIOR (1 lapis plamir, 1 lapis cat dasar, 2 lapis cat penutup)					
	Propan/mowilex --> exterior					
	Bahan					
	0.100 Kg Propan Alkali	Rp 55,000.00	5,500.00			
	0.100 Kg Cat dasar	Rp 35,000.00	3,500.00			

	0.260 Kg Cat penutup 2x	Rp	35,000.00	9,100.00			
	Upah						
	0.020 Oh Pekerja	Rp	65,000.00		1,300.00		
	0.063 Oh Tukang Cat	Rp	70,000.00		4,410.00		
	0.0063 Oh Kepala Tukang	Rp	75,000.00		472.50		
	0.0025 Oh Mandor	Rp	80,000.00		200.00		
				18,100.00	6,382.50	24,482.50	24,400.00
9	Analisa Universitas						
	1 m ² Pengecatan Tembok lama EXTERIOR (1 lapis plamir, 1 lapis cat dasar, 2 lapis cat penutup)						
	Propan/mowilex --> exterior						
	Bahan						
	0.100 Kg Cat dasar	Rp	35,000.00	3,500.00			
	0.260 Kg Cat penutup 2x	Rp	35,000.00	9,100.00			
	Upah						
	0.020 Oh Pekerja	Rp	65,000.00		1,300.00		
	0.063 Oh Tukang Cat	Rp	70,000.00		4,410.00		
	0.0063 Oh Kepala Tukang	Rp	75,000.00		472.50		
	0.0025 Oh Mandor	Rp	80,000.00		200.00		
				12,600.00	6,382.50	18,982.50	18,900.00
10	Analisa SNI DPU Cipta Karya dan Tata Ruang						
	1 m ² Pengecatan Plafond (1 lapis plamir, 1 lapis cat dasar, 2 lapis cat penutup)						
	Catilac INTERIOR						
	Bahan						
	0.100 Kg Plamir tembok	Rp	7,000.00	700.00			
	0.100 Kg Cat dasar	Rp	35,000.00	3,500.00			
	0.260 Kg Cat penutup 2x	Rp	35,000.00	9,100.00			
	Upah						
	0.020 Oh Pekerja	Rp	65,000.00		1,300.00		
	0.063 Oh Tukang Cat	Rp	70,000.00		4,410.00		
	0.0063 Oh Kepala Tukang	Rp	75,000.00		472.50		
	0.0025 Oh Mandor	Rp	80,000.00		200.00		

				13,300.00	6,382.50	19,682.50	19,600.00
11	Analisa SNI DPU Cipta Karya dan Tata Ruang						
	pelapisan 1 m ² mortar						
	Bahan						
	3.250 Kg mortar	Rp	2,000.00	6,500.00			
	Upah						
	0.020 Oh Pekerja	Rp	65,000.00		1,300.00		
	0.063 Oh Tukang	Rp	70,000.00		4,410.00		
	0.006 Oh Kepala tukang	Rp	75,000.00		472.50		
	0.003 Oh Mandor	Rp	80,000.00		200.00		
				6,500.00	6,382.50	12,882.50	12,800.00
12	Analisa SNI DPU Cipta Karya dan Tata Ruang						
	1 m ² Pengecatan Tembok lama (1 lapis cat dasar, 2 lapis cat penutup)						
	Bahan						
	0.120 Kg Cat dasar	Rp	35,000.00	4,200.00			
	0.180 Kg Cat penutup 2x	Rp	35,000.00	6,300.00			
	Upah						
	0.028 Oh Pekerja	Rp	65,000.00		1,820.00		
	0.042 Oh Tukang Cat	Rp	70,000.00		2,940.00		
	0.0042 Oh Kepala Tukang	Rp	75,000.00		315.00		
	0.0025 Oh Mandor	Rp	80,000.00		200.00		
				10,500.00	5,275.00	15,775.00	15,700.00
13	Analisa Sendiri						
	1 m2 Wallpaper "STANDART"						
	Bahan						
	0.240 roll Wall papper	Rp	240,000.00	57,600.00			
	0.200 Kg Perekat	Rp	11,500.00	2,300.00			
	Upah						
	0.020 Oh Pekerja	Rp	65,000.00		1,300.00		
	0.200 Oh Tukang Cat	Rp	70,000.00		14,000.00		
	0.002 Oh Kepala Tukang	Rp	75,000.00		150.00		

	0.0025 Oh Mandor	Rp	80,000.00		200.00		
				59,900.00	15,650.00	75,550.00	75,000.00
14	Analisa Sendiri						
	1 m ² Wallpaper "DELUXE"						
	Bahan						
	0.079 roll Wall papper	Rp	240,000.00	18,867.92			
	0.200 Kg Perekat	Rp	11,500.00	2,300.00			
	Upah						
	0.020 Oh Pekerja	Rp	65,000.00		1,300.00		
	0.200 Oh Tukang Cat	Rp	70,000.00		14,000.00		
	0.002 Oh Kepala Tukang	Rp	75,000.00		150.00		
	0.0025 Oh Mandor	Rp	80,000.00		200.00		
				21,167.92	15,650.00	36,817.92	37,000.00
15	Analisa SNI DPU Cipta Karya dan Tata Ruang						
	1 m ² Pengecatan Genteng (1 lapis cat dasar, 2 lapis cat penutup)						
	Bahan						
	0.120 Kg Cat dasar	Rp	35,000.00	4,200.00			
	0.180 Kg Cat penutup 2x	Rp	35,000.00	6,300.00			
	Upah						
	0.028 Oh Pekerja	Rp	65,000.00		1,820.00		
	0.042 Oh Tukang Cat	Rp	70,000.00		2,940.00		
	0.0042 Oh Kepala Tukang	Rp	75,000.00		315.00		
	0.0025 Oh Mandor	Rp	80,000.00		200.00		
				10,500.00	5,275.00	15,775.00	15,700.00
16	Analisa SNI DPU Cipta Karya dan Tata Ruang						
	1 m ² Pengecatan permukaan baja dengan meni besi						
	Bahan						
	0.100 Kg Meni besi	Rp	22,000.00	2,200.00			
	0.010 Bh Kuas	Rp	22,000.00	220.00			
	Upah						
	0.020 Oh Pekerja	Rp	65,000.00		1,300.00		

	0.200 Oh Tukang Cat	Rp	70,000.00		14,000.00		
	0.020 Oh Kepala Tukang	Rp	75,000.00		1,500.00		
	0.010 Oh Mandor	Rp	80,000.00		800.00		
				2,420.00	17,600.00	20,020.00	20,000.00
17	Analisa SNI DPU Cipta Karya dan Tata Ruang						
	1 m ² Pengecatan permukaan besi/baja (1 lapis meni besi, 2 lapis cat penutup)						
	Bahan						
	0.120 Kg Meni besi	Rp	22,000.00	2,640.00			
	0.260 kg Cat besi	Rp	22,000.00	5,720.00			
	0.060 Ltr Minyak cat	Rp	4,000.00	240.00			
	Upah						
	0.023 Oh Pekerja	Rp	65,000.00		1,495.00		
	0.225 Oh Tukang Cat	Rp	70,000.00		15,750.00		
	0.150 Oh Kepala Tukang	Rp	75,000.00		11,250.00		
	0.008 Oh Mandor	Rp	80,000.00		640.00		
				8,600.00	29,135.00	37,735.00	37,700.00
18	Analisa SNI DPU Cipta Karya dan Tata Ruang						
	1 m ² Pengecatan Eternit baru (1 lapis plamir, 1 lapis cat dasar, 2 lapis cat penutup)						
	Bahan						
	0.100 Kg Plamir tembok	Rp	7,000.00	700.00			
	0.100 Kg Cat dasar	Rp	35,000.00	3,500.00			
	0.260 Kg Cat penutup 2x	Rp	35,000.00	9,100.00			
	Upah						
	0.025 Oh Pekerja	Rp	65,000.00		1,625.00		
	0.100 Oh Tukang Cat	Rp	70,000.00		7,000.00		
	0.0100 Oh Kepala Tukang	Rp	75,000.00		750.00		
	0.0030 Oh Mandor	Rp	80,000.00		240.00		
				13,300.00	9,615.00	22,915.00	22,900.00

**ANALISA SATUAN PEKERJAAN
KABUPATEN JEMBER 2017**

Pekerjaan Kunci dan Kaca

NO.	JENIS PEKERJAAN	BAHAN	UPAH	JUMLAH	BULAT
1	2	3	4	5	6
1	Analisa SNI DPU Cipta Karya dan Tata Ruang				
	1 buah Pasang kunci pintu 2x putar				
	Bahan				
	1.000 Bh Kunci pintu 2x putar Rp 110,000.00	110,000.00			
	Upah				
	0.060 Pekerja Rp 65,000.00		3900		
	0.600 Tukang Kayu Rp 70,000.00		42000		
	0.060 Kepala Tukang Rp 75,000.00		4500		
	0.003 Mandor Rp 80,000.00		240		
		110,000.00	50,640.00	160,640.00	160,600.00
2	Analisa SNI DPU Cipta Karya dan Tata Ruang				
	1 buah Pasang kunci pintu 1x putar				
	Bahan				
	1.000 Bh Kunci pintu 1x putar Rp 3,200.00	100,000.00			
	Upah				
	0.010 Pekerja Rp 65,000.00		650.00		
	0.500 Tukang Kayu Rp 70,000.00		35,000.00		
	0.010 Kepala Tukang Rp 75,000.00		750.00		
	0.005 Mandor Rp 80,000.00		400.00		
		100,000.00	36,800.00	136,800.00	136,800.00
3	Analisa SNI DPU Cipta Karya dan Tata Ruang				
	1 set Pasang engsel pintu				
	Bahan				
	1.000 set Engsel nylon pintu Rp 30,000.00	30,000.00			

	Upah						
	0.015 Pekerja	Rp	65,000.00		975.00		
	0.150 Tukang Kayu	Rp	70,000.00		10,500.00		
	0.015 Kepala Tukang	Rp	75,000.00		1,125.00		
	0.00075 Mandor	Rp	80,000.00		60.00		
				30,000.00	12,660.00	42,660.00	42,600.00
4	Analisa SNI DPU Cipta Karya dan Tata Ruang						
	1 set Pasang engsel jendela						
	Bahan						
	1.000 set Engsel nylon jendela	Rp	16,000.00				
	Upah						
	0.010 Pekerja	Rp	65,000.00		650.00		
	0.100 Tukang Kayu	Rp	70,000.00		7,000.00		
	0.010 Kepala Tukang	Rp	75,000.00		750.00		
	0.00050 Mandor	Rp	80,000.00		40.00		
				-	8,440.00	8,440.00	8,400.00
5	Analisa SNI DPU Cipta Karya dan Tata Ruang						
	1 set Pasang Hak angin maju mundur						
	Bahan						
	1.000 set Hak Angin lurus biasa (setel maju mundur)	Rp	3,000.00	3,000.00			
	Upah						
	0.015 Pekerja	Rp	65,000.00		975.00		
	0.150 Tukang Kayu	Rp	70,000.00		10,500.00		
	0.015 Kepala Tukang	Rp	75,000.00		1,125.00		
	0.00750 Mandor	Rp	80,000.00		600.00		
				3,000.00	13,200.00	16,200.00	16,200.00
6	Analisa SNI DPU Cipta Karya dan Tata Ruang						
	1 m2 Pasang kaca tebal 3mm bening						
	Bahan						
	1.100 m2 Kaca 3 mm bening polos	Rp	88,000.00	96,800.00			
	Upah						
	0.015 Pekerja	Rp	65,000.00		975.00		

	0.150	Tukang Kayu	Rp	70,000.00		10,500.00		
	0.015	Kepala Tukang	Rp	75,000.00		1,125.00		
	0.00075	Mandor	Rp	80,000.00		60.00		
					96,800.00	12,660.00	109,460.00	109,400.00
7	Analisa SNI DPU Cipta Karya dan Tata Ruang							
	1 m2 Pasang kaca tebal 5mm bening							
	Bahan							
	1.100	m2 Kaca 5 mm bening polos	Rp	125,000.00	137,500.00			
	Upah							
	0.015	Pekerja	Rp	65,000.00		975.00		
	0.150	Tukang Kayu	Rp	70,000.00		10,500.00		
	0.015	Kepala Tukang	Rp	75,000.00		1,125.00		
	0.00075	Mandor	Rp	80,000.00		60.00		
					137,500.00	12,660.00	150,160.00	150,100.00
8	Analisa SNI DPU Cipta Karya dan Tata Ruang							
	1 m2 Pasang kaca Rayban tebal 5 mm							
	Bahan							
	1.100	m2 Kaca Rayban 5 mm	Rp	71,000.00	78,100.00			
	Upah							
	0.015	Pekerja	Rp	65,000.00		975.00		
	0.150	Tukang Kayu	Rp	70,000.00		10,500.00		
	0.015	Kepala Tukang	Rp	75,000.00		1,125.00		
	0.00075	Mandor	Rp	80,000.00		60.00		
					78,100.00	12,660.00	90,760.00	90,700.00
9	Analisa SNI DPU Cipta Karya dan Tata Ruang							
	1 m2 Pasang kaca eS tebal 5 mm							
	Bahan							
	1.100	m2 Kaca ES 5 mm	Rp	185,000.00	203,500.00			
	Upah							
	0.015	Pekerja	Rp	65,000.00		975.00		
	0.150	Tukang Kayu	Rp	70,000.00		10,500.00		
	0.015	Kepala Tukang	Rp	75,000.00		1,125.00		
	0.00075	Mandor	Rp	80,000.00		60.00		

					203,500.00	12,660.00	216,160.00	216,100.00
10	Analisa SNI DPU Cipta Karya dan Tata Ruang							
	1 buah Pasang grendel tanam jendela							
	Bahan							
	1.000 Bh Grendel pernekel biasa	Rp	7,000.00		7,000.00			
	Upah							
	0.010 Pekerja	Rp	65,000.00			650.00		
	0.100 Tukang Kayu	Rp	70,000.00			7,000.00		
	0.010 Kepala Tukang	Rp	75,000.00			750.00		
	0.00050 Mandor	Rp	80,000.00			40.00		
					7,000.00	8,440.00	15,440.00	15,400.00
11	Analisa SNI DPU Cipta Karya dan Tata Ruang							
	1 buah Pasang grendel tanam pintu							
	Bahan							
	1.000 Bh Grendel pernekel	Rp	7,000.00		7,000.00			
	Upah							
	0.010 Pekerja	Rp	65,000.00			650.00		
	0.100 Tukang Kayu	Rp	70,000.00			7,000.00		
	0.010 Kepala Tukang	Rp	75,000.00			750.00		
	0.00050 Mandor	Rp	80,000.00			40.00		
					7,000.00	8,440.00	15,440.00	15,400.00
12	Analisa SNI DPU Cipta Karya dan Tata Ruang							
	1 buah Pasang grendel tanam pintu							
	Bahan							
	1.000 Bh Grendel tanam coklat	Rp	60,000.00		60,000.00			
	Upah							
	0.010 Pekerja	Rp	65,000.00			650.00		
	0.100 Tukang Kayu	Rp	70,000.00			7,000.00		
	0.010 Kepala Tukang	Rp	75,000.00			750.00		
	0.00050 Mandor	Rp	80,000.00			40.00		
					60,000.00	8,440.00	68,440.00	68,400.00
13	Analisa SNI DPU Cipta Karya dan Tata Ruang							
	1 m2 Pasang Kawat Harmonika							

	Bahan							
	1.000	m2 Pas. Kawat Harmonika	Rp	32,000.00	32,000.00			
	0.030	Kg Paku	Rp	25,000.00	750.00			
	Upah							
	0.487	Pekerja	Rp	65,000.00		31,655.00		
	0.075	Tukang Kayu	Rp	70,000.00		5,250.00		
	0.008	Kepala Tukang	Rp	75,000.00		600.00		
	0.02400	Mandor	Rp	80,000.00		1,920.00		
					32,750.00	39,425.00	72,175.00	72,100.00

**ANALISA SATUAN PEKERJAAN
KABUPATEN JEMBER 2017**

Pekerjaan Listrik

NO.	JENIS PEKERJAAN	BAHAN	UPAH	JUMLAH	BULAT
1	2	3	4	5	6
1	Analisa SNI DPU Cipta Karya dan Tata Ruang				
	Memasang 1 bh Titik Lampu				
	Bahan				
	15.000 m' Kabel NYA 1x2,5 mm Rp 2,500.00	37,500.00			
	1.000 ljr Pipa paralon 5/8" Rp 4,500.00	4,500.00			
	1.000 Bh Sakkelar Rp 11,000.00	11,000.00			
	1.000 Bh Isolator Rp 6,600.00	6,600.00			
	1.000 Bh Las Dop Rp 700.00	700.00			
	1.000 Bh Fiting Plafond Rp 6,200.00	6,200.00			
	1.000 Bh T.Dos PVC Rp 2,400.00	2,400.00			
	Upah				
	1.000 Oh Pekerja Rp 65,000.00		65,000.00		
	1.000 Oh Tukang listrik Rp 70,000.00		70,000.00		
	0.050 Oh Kepala Tukang Rp 75,000.00		3,750.00		
		68,900.00	138,750.00	207,650.00	207,600.00
2	Analisa SNI DPU Cipta Karya dan Tata Ruang				
	Memasang 1 Titik Stop Kontak				
	Bahan				
	10.000 m' Kabel NYA 1x2,5 mm Rp 2,500.00	25,000.00			
	0.200 ljr Pipa paralon 5/8" Rp 4,500.00	900.00			
	1.000 Bh Stop kontak Rp 13,000.00	13,000.00			
	1.000 Bh T.Dos PVC Rp 2,400.00	2,400.00			
	Upah				
	0.05 Oh Pekerja Rp 65,000.00		3,250.00		
	0.5 Oh Tukang listrik Rp 70,000.00		35,000.00		
	0.005 Oh Kepala Tukang Rp 75,000.00		375.00		

					41,300.00	38,625.00	79,925.00	79,900.00
3	Analisa SNI DPU Cipta Karya dan Tata Ruang							
	Memasang 1 Set Panel Box							
	Bahan							
	1 Set set Panel Box	Rp	37,800.00		37,800.00			
	1 Bh bh MCB 10 Amp	Rp	70,400.00		70,400.00			
	1 set Set Miniswitch 32 Amp	Rp	317,900.00		317,900.00			
	1 Ls Ls. Alat bantu/cleaner	Rp	106,525.00		106,525.00			
	Upah							
	1.000 Oh Pekerja	Rp	65,000.00		65,000.00			
	1.000 Oh Tukang listrik	Rp	70,000.00		70,000.00			
	0.050 Oh Kepala Tukang	Rp	75,000.00		3,750.00			
					532,625.00	138,750.00	671,375.00	671,300.00
4	Analisa SNI DPU Cipta Karya dan Tata Ruang							
	Memasang 1 Set lampu TL 1 x 20 Watt							
	Bahan + upah							
	1 Bh Lampu TL 20 Watt	Rp	135,000.00		135,000.00			
	1 Ls Upah kerja	Rp	13,500.00			13,500.00		
					135,000.00	13,500.00	148,500.00	148,500.00
5	Analisa SNI DPU Cipta Karya dan Tata Ruang							
	Memasang 1 Set lampu TL 1 x 40 Watt							
	Bahan + upah							
	1 Bh Lampu TL 40 Watt	Rp	165,000.00		165,000.00			
	1 Ls Upah kerja	Rp	16,500.00			16,500.00		
					165,000.00	16,500.00	181,500.00	181,500.00
	Analisa SNI DPU Cipta Karya dan Tata Ruang							
	Memasang 1 Set lampu TL 2 x 40 Watt Full Reflektor							
	Bahan + upah							
	1 Bh Lampu TL 2 x 40 Watt	Rp	474,960.00		474,960.00			
	1 Ls Upah kerja	Rp	47,496.00			47,496.00		
					474,960.00	47,496.00	522,456.00	522,400.00
	Analisa SNI DPU Cipta Karya dan Tata Ruang							
	Memasang 1 Set lampu TL LED 1 x 9 Watt							

	Bahan + upah						
	1 Bh Lampu TL LED 1 x 9 Watt Rp	111,100.00	111,100.00				
	1 Ls Upah kerja Rp	11,110.00		11,110.00			
			111,100.00	11,110.00	122,210.00		122,200.00
	Analisa SNI DPU Cipta Karya dan Tata Ruang						
	Memasang 1 Set lampu TL LED 1 x 18 Watt						
	Bahan + upah						
	1 Bh Lampu TL LED 1 x 18 Watt Rp	171,600.00	171,600.00				
	1 Ls Upah kerja Rp	17,160.00		17,160.00			
			171,600.00	17,160.00	188,760.00		188,700.00
	Analisa SNI DPU Cipta Karya dan Tata Ruang						
	Memasang 1 Set lampu SL 18 Watt						
	Bahan + upah						
	1 Bh Lampu SL 18 Watt Rp	44,000.00	44,000.00				
	1 Ls Upah kerja Rp	4,400.00		4,400.00			
			44,000.00	4,400.00	48,400.00		48,400.00
6	Analisa SNI DPU Cipta Karya dan Tata Ruang						
	Memasang 1 Set armatur lampu pijar 25 Watt						
	Bahan + upah						
	1 Bh Armatur lampu pijar 25 W Rp	20,000.00	20,000.00				
	1 Ls Upah kerja Rp	2,000.00		2,000.00			
			20,000.00	2,000.00	22,000.00		22,000.00
7	Analisa SNI DPU Cipta Karya dan Tata Ruang						
	Memasang 1 Set armatur lampu 2x20 W Full Reflektor						
	Bahan + upah						
	1 Bh Armatur 2x20 W full Reflek Rp	90,750.00	90,750.00				
	1 Ls Upah kerja Rp	9,075.00		9,075.00			
			90,750.00	9,075.00	99,825.00		99,800.00
8	Analisa SNI DPU Cipta Karya dan Tata Ruang						
	Memasang 1 Set armatur lampu Downlight 1 x 20 w						
	Bahan + upah						
	1 Bh Armatur Downlight 20 W Rp	18,700.00	18,700.00				
	1 Ls Upah kerja Rp	1,870.00		1,870.00			

				18,700.00	1,870.00	20,570.00	20,500.00
9	Analisa sendiri						
	Memasang AC. Window 2 PK Ex Jepang						
	Bahan						
	1 Unit AC. Window 2 PK	Rp	13,435,500.00	13,435,500.00			
	1 Unit Assesories	Rp	671,775.00	671,775.00			
	Upah						
	1.000 Ls Upah pasang	Rp	1,343,550.00		1,343,550.00		
				14,107,275.00	1,343,550.00	15,450,825.00	15,450,800.00
10	Analisa sendiri						
	Memasang AC. Window 1,5 PK Ex Jepang						
	Bahan						
	1 Unit AC. Window 1,5 PK	Rp	7,166,100.00	7,166,100.00			
	1 Unit Assesories	Rp	358,305.00	358,305.00			
	Upah						
	1.000 Ls Upah pasang	Rp	716,610.00		716,610.00		
				7,524,405.00	716,610.00	8,241,015.00	8,241,000.00
11	Analisa sendiri						
	Memasang AC. Window 1 PK Ex Jepang						
	Bahan						
	1 Unit AC. Window 1 PK	Rp	6,269,000.00	6,269,000.00			
	1 Unit Assesories	Rp	313,450.00	313,450.00			
	Upah						
	1.000 Ls Upah pasang	Rp	626,900.00		626,900.00		
				6,582,450.00	626,900.00	7,209,350.00	7,209,300.00
	Analisa sendiri						
	Memasang AC. Ceiling 1/2 PK Ex Jepang						
	Bahan						
	1 Unit AC. Ceiling 1/2 PK	Rp	3,646,800.00	3,646,800.00			
	1 Unit Assesories	Rp	182,340.00	182,340.00			
	Upah						
	1.000 Ls Upah pasang	Rp	364,680.00		364,680.00		

					3,829,140.00	364,680.00	4,193,820.00	4,193,800.00
12	Analisa sendiri							
	Memasang Exhaust Fan Ex Jepang							
	Bahan							
	1 Unit Exhaust fan	Rp	984,100.00		984,100.00			
	1 Unit Assesories	Rp	49,205.00		49,205.00			
	Upah							
	1.000 Ls Upah pasang	Rp	98,410.00			98,410.00		
					1,033,305.00	98,410.00	1,131,715.00	1,131,700.00
13	Analisa sendiri							
	Memasang kipas angin gantung Ex Jepang							
	Bahan							
	1 Unit Kipas angin gantung	Rp	825,000.00		825,000.00			
	1 Unit Assesories	Rp	41,250.00		41,250.00			
	Upah							
	1.000 Ls Upah pasang	Rp	82,500.00			82,500.00		
					866,250.00	82,500.00	948,750.00	948,700.00
	Analisa SNI DPU Cipta Karya dan Tata Ruang							
	Memasang 1 Set lampu LED 7 Watt							
	Bahan + upah							
	1 Bh Lampu LED 7 Watt	Rp	111,100.00		111,100.00			
	1 Ls Upah kerja	Rp	11,110.00			11,110.00		
					111,100.00	11,110.00	122,210.00	122,200.00
	Analisa SNI DPU Cipta Karya dan Tata Ruang							
	Memasang 1 Set lampu LED 9 Watt							
	Bahan + upah							
	1 Bh Lampu LED 9 Watt	Rp	66,000.00		66,000.00			
	1 Ls Upah kerja	Rp	6,600.00			6,600.00		
					66,000.00	6,600.00	72,600.00	72,600.00
	Analisa SNI DPU Cipta Karya dan Tata Ruang							
	Memasang 1 Set lampu LED 12 Watt							
	Bahan + upah							
	1 Bh Lampu LED 12 Watt	Rp	100,100.00		100,100.00			

	1 Ls	Upah kerja	Rp	10,010.00		10,010.00		
					100,100.00	10,010.00	110,110.00	110,100.00
Analisa SNI DPU Cipta Karya dan Tata Ruang								
Memasang 1 Set lampu LED 14 Watt								
Bahan + upah								
	1 Bh	Lampu LED 14 Watt	Rp	111,100.00	111,100.00			
	1 Ls	Upah kerja	Rp	11,110.00		11,110.00		
					111,100.00	11,110.00	122,210.00	122,200.00



DAFTAR HARGA SATUAN DASAR BAHAN
KABUPATEN JEMBER

NO	ANALISA	SATUAN VOLUME	HARGA SATUAN
A Pekerjaan Persiapan			
1	1 m' pagar sementara dari seng gelombang tinggi 2 meter	m'	353,800.00
2	1 m' pagar sementara dari kawat duri tinggi 1,8 meter	m'	341,400.00
3	1 m' Pengukuran dan Pas. Bouwplank	m'	69,400.00
4	1 m2 pembuatan kantor sementara dengan lantai plesteran	m2	1,063,800.00
5	1 m2 membersihkan lapangan dan perataan	m2	10,500.00
6	1 m3 bongkaran beton bertulang	m3	919,900.00
7	1 m3 bongkaran dinding tembok bata merah	m3	459,900.00
B Pekerjaan Tanah			
1	Menggali 1 m3 tanah biasa sedalam 1 m	m3	50,700.00
2	Menggali 1 m3 tanah biasa sedalam 2 m	m3	62,100.00
3	Menggali 1 m3 tanah biasa sedalam 3 m	m3	73,600.00
4	Menggali 1 m3 tanah Keras sedalam 1 m	m3	67,500.00
5	Mengerjakan 1 m2 stripping tebing setinggi 1 m	m2	3,600.00
6	Membuang 1 m3 tanah sejauh 15 m	m3	22,200.00
7	Mengurug kembali 1 m3 galian	m3	36,500.00
8	Mengurug 1 m3 pasir urug	m3	106,700.00
9	Memasang 1 m2 lapisan ijuk tebal 10 cm, untuk bidang resapan	m2	19,900.00
10	Mengurug 1 m3 sirtu padat untuk peninggian lantai bangunan	m3	96,200.00
11	Mengurug 1 m3 tanah dengan pemadatan	m3	95,000.00
C Pekerjaan Pondasi			
1	Memasang 1 m3 pondasi batu belah, camp. 1 PC : 3 PP	m3	801,500.00
2	Memasang 1 m3 pondasi batu belah, camp. 1 PC : 4 PP	m3	728,400.00

3	Memasang 1 m3 pondasi batu belah, camp. 1 PC : 5 PP	m3	677,700.00
4	Memasang 1 m3 pondasi batu belah, camp. 1 PC : 6 PP	m3	642,100.00
5	Memasang 1 m3 pondasi batu belah, camp. 1 PC : 8 PP	m3	593,300.00
6	Memasang 1 m3 batu belah, camp. 1 KP : 1 Sm' : 2 PP	m3	402,300.00
7	Memasang 1 m3 batu belah, camp. 1PC : 3KP : 10PP	m3	521,600.00
8	Memasang 1 m3 batu belah, camp. 1/2PC : 1KP : 4PP	m3	485,800.00
9	Memasang 1 m3 batu kosong (anstamping)	m3	283,100.00
10	Memasang 1 m3 pondasi siklop,80% beton campuran 1PC : 2PS : 3KR dan 40% batu belah	m3	1,895,100.00
11	Memasang 1 m3 pondasi sumuran diameter 100 cm	m3	783,000.00
D Pekerjaan Dinding			
1	Memasang 1 m2 dinding bata merah Uk. (5x11x22) cm tb. 1 bata , camp. 1PC : 3 PP	m2	191,500.00
2	Memasang 1 m2 dinding bata merah Uk. (5x11x22) cm tb. 1 bata , camp. 1PC : 6 PP	m2	166,900.00
3	Memasang 1 m2 dinding bata merah Uk. (5x11x22) cm tb. 1 bata , camp. 1PC : 3 KP : 10 PP	m2	146,200.00
4	Memasang 1 m2 dinding bata merah Uk. (5x11x22) cm tb. 1/2 bata , camp. 1PC : 3 PP	m2	90,700.00
5	Memasang 1 m2 dinding bata merah Uk. (5x11x22) cm tb. 1/2 bata , camp. 1PC : 5 PP	m2	82,100.00
6	Memasang 1 m2 dinding bata merah Uk. (5x11x22) cm tb. 1/2 bata , camp. 1PC : 6 PP	m2	79,900.00
7	Memasang 1 m2 dinding bata merah Uk. (5x11x22) cm tb. 1/2 bata , camp. 1PC : 8 PP	m2	76,400.00
8	Memasang 1 m2 dinding bata merah Uk. (5x11x22) cm tb. 1/2 bata , camp. 1PC : 3 KP : 10 PP	m2	72,500.00
9	Memasang 1 m2 dinding terawang (ROSTER) Uk. (12x11x24) cm, camp. 1PC : 4 PP	m2	356,500.00
10	Memasang 1 m2 Batu Candi Uk. (10x20x1.5) cm, camp. 1PC : 4 PP	m2	205,300.00
E Pekerjaan Plesteran			
1	Memasang 1 m2 Plesteran camp. 1 Pc : 3 Ps tebal 15mm	m2	51,000.00
2	Memasang 1 m2 Plesteran camp. 1 Pc : 5 Ps tebal 15mm	m2	46,300.00
3	Memasang 1 m2 Plesteran camp. 1 Pc : 6 Ps tebal 15mm	m2	44,900.00
4	Memasang 1 m2 Plesteran camp. 1 Pc : 8 Ps tebal 15mm	m2	43,200.00
5	Memasang 1 m2 Plesteran camp. 1 Pc : ½ KP : 3 Ps tebal 15mm	m2	47,500.00
6	Memasang 1 m2 Plesteran camp. 1 Pc : 2 KP : 8 Ps tebal 15mm	m2	42,900.00
7	Memasang 1 m2 Plesteran camp. 1 PC : 3 Ps tebal 20mm	m2	59,200.00
8	Memasang 1 m2 Plesteran camp. 1 PC : 5 Ps tebal 20mm	m2	61,900.00

9	Memasang 1 m2 Berapen camp. 1 PC : 5 Ps tebal 15mm	m2	30,200.00
10	Memasang 1 m2 finishing siar pas. dinding bata merah (=20m')	m2	22,400.00
11	Memasang 1 m2 finishing siar pas. batu kali adukan 1 PC : 2 Ps.	m2	46,600.00
12	Memasang 1 m2 Acian	m2	28,000.00
13	Memasang 1 m' Benangan 1 PC : 2 PP	m'	15,100.00
F Pekerjaan Kayu			
1	Membuat dan Memasang 1 m3 Kusen Pintu dan Jusen Jendela, Kayu Kl. I	m3	12,042,000.00
2	Membuat dan Memasang 1 m3 Kusen Pintu dan Jusen Jendela, Kayu Kl. II atau Kl. III	m3	7,840,500.00
	Membuat dan Memasang 1 m3 Kusen Pintu dan Jusen Jendela, Kayu Kl. II atau Kl. III	m3	4,837,500.00
3	Membuat dan Memasang 1 m2 Pintu klamp standar, Kayu Kl. II	m2	346,300.00
4	Membuat dan Memasang 1 m2 Pintu klamp Sederhana, Kayu Kl. III untuk gudang sementara	m2	246,300.00
5	Membuat dan Memasang 1 m2 Daun Pintu Panel, Kayu Kl. I atau II	m2	707,200.00
	Membuat dan Memasang 1 m2 Daun Pintu Panel, Kayu Kl. I atau II	m2	507,200.00
6	Membuat dan Memasang Daun Pintu & Jendela Kaca Kayu Kl. I		484,600.00
	Membuat dan Memasang Daun Pintu & Jendela Kaca Kayu Kl. II		364,600.00
7	Membuat dan Memasang Daun Pintu & Jendela Jalusi Kayu Kl. I		947,200.00
	Membuat dan Memasang Daun Pintu & Jendela Jalusi Kayu Kl. II		627,200.00
8	Membuat 1 m2 Daun Pintu Lapis (plywood) rangkap, rangka tertutup kayu Kl. I (lebar sampai 90cm)	m2	552,200.00
9	Membuat 1 m2 Pintu plywood rangkap, rangka expose kayu Kl. I atau II	m2	588,400.00
	Membuat 1 m2 Pintu plywood rangkap, rangka expose kayu Kl. I atau II	m2	460,400.00
10	Membuat jalusi kusen kayu kl. I		827,700.00
	Membuat jalusi kusen kayu kl. II		527,700.00
11	Membuat 1 m2 taekwood rangkap, rangka expose kayu Kl. I	m2	577,100.00
12	Memasang 1 m3 Konstruksi Kuda kuda Konvensional, kayu klas I, II, dan III bentang 6 meter	m3	11,420,600.00
	Memasang 1 m3 Konstruksi Kuda kuda Konvensional, kayu klas I, II, dan III bentang 6 meter	m3	7,020,600.00
	Memasang 1 m3 Konstruksi Kuda kuda Konvensional, kayu klas I, II, dan III bentang 6 meter	m3	4,190,600.00
13	Upah Membongkar 1 m3 Konstruksi Kuda kuda Konvensional, kayu klas I, II, dan III bentang 6 meter	m3	1,206,000.00
	Upah Membongkar 1 m3 Konstruksi Kuda kuda Konvensional, kayu klas I, II, dan III bentang 6 meter	m3	1,206,000.00
	Upah Membongkar 1 m3 Konstruksi Kuda kuda Konvensional, kayu klas I, II, dan III bentang 6 meter	m3	1,206,000.00
14	Memasang 1 m3 Konstruksi Kuda kuda Ekspose kayu klas I	m3	13,134,600.00

15	Memasang 1 m3 Konstruksi Gording kayu klas III	m3	4,296,600.00
16	Memasang 1 m2 rangka atap genteng keramik, kayu kl. II	m2	106,600.00
17	Memasang 1 m2 Reng genteng keramik, kayu kl. II	m2	35,000.00
18	Memasang 1 m2 rangka atap genteng beton, kayu kl. II	m2	124,600.00
19	Memasang 1 m2 rangka atap sirap, kayu kelas II	m2	845,700.00
20	Memasang 1 m2 rangka langit-langit (50x100)cm, kayu kelas II	m2	119,200.00
21	Memasang 1 m2 rangka langit-langit (60 x 60)cm, kayu kelas II	m2	122,500.00
22	Memasang lisplank uk (3 x 20)cmkayu kelas I	m'	132,000.00
	Memasang lisplank uk (3 x 20)cmkayu kelas II	m'	78,000.00
23	Memasang 1 m' lisplank ukuran (3 x 30)cm, kayu kelas I atau II	m'	133,200.00
	Memasang 1 m' lisplank ukuran (3 x 30)cm, kayu kelas I atau II	m'	78,200.00
24	Memasang 1 m2 rangka dinding pemisah teakwood rangkap, rangka kayu kelas II	m2	264,600.00
26	Memasang 1 m2 rangka dinding pemisah plywood rangkap lapis HPL, rangka kayu kelas II	m2	478,300.00
27	Memasang 1 m2 rangka dinding pemisah plywood rangkap lapis Wallpaper, rangka kayu kelas II	m2	399,000.00
28	Memasang 1 rangka dinding pemisah plywood rangkap lapis HPL,PR1	m2	1,196,100.00
29	Memasang 1 rangka dinding pemisah plywood rangkap lapis HPL,PR2	m2	747,500.00
30	Memasang rangka dinding pemisah plywood rangkap lapis HPL,PR3	m2	1,096,400.00
31	Memasang rangka dinding pemisah plywood rangkap lapis HPL,PR4	m2	1,993,500.00
32	Memasang rangka dinding pemisah plywood rangkap lapis HPL,PR5	m2	4,596,100.00
33	Memasang rangka dinding pemisah plywood rangkap lapis HPL,PR6	m2	4,289,700.00
34	Memasang rangka dinding pemisah plywood rangkap lapis HPL,Etalase	m2	5,976,000.00
35	Memasang rangka dinding pemisah plywood rangkap lapis HPL,entrance	m2	3,122,100.00
36	Memasang 1 m2 dinding Lambriziring dari papan kayu kelas I	m2	260,700.00
37	Memasang 1 m2 Pasang Papan Kompres tebal 2,5 cm, kayu papan kls. I	m2	359,900.00
38	Memasang 1 m2 Papan reuter 2/20 cm kayu meranti Kelas II	m2	32,600.00
39	Memasang 1 m2 rangka langit-langit (100 x 100) cm	m2	68,600.00
G	Pekerjaan Baja		
1	Pek. wf 200.100.5,5.8mm	kg	8,000.00
2	Plat bertulang 6mm	kg	8,000.00
3	Plat plendes kuda-kuda 8mm	kg	8,000.00

4	Plat sepatu kolom 10mm	kg	8,000.00
5	Trek hordeng bs 10mm	kg	11,500.00
6	Tali angin bs 12mm	kg	11,500.00
7	Spansecruw M-16	unit	51,700.00
8	Baut angkur 12mm	bj	28,700.00
9	Baut kuda-kuda 1/2 x 1 1/2 inc	bj	2,300.00
10	Baut hordeng & trek hordeng	bj	1,700.00
11	CNP.150. 50. 2,3mm	kg	13,800.00
12	Driling secruw 3 inc	pcs	1,100.00
13	Pasang rangka atap baja ringan sudut 30-35-40-45 derajat bentang maximal 10 m	m2	304,100.00
H Pekerjaan Beton			
1	Pasang SLOOF 15/20 K. 175 (Ø 10 mm - Beugel Ø 6 mm)	m3	14,194,600.00
2	Pasang KOLOM 15/15 K. 175 (Ø 10 mm - Beugel Ø 6 mm)	m3	20,039,900.00
3	Pasang KOLOM 15/30 K. 175 (Ø 12 mm - Beugel Ø 8 mm)	m3	19,856,700.00
4	Pasang BALOK 15/20 K. 175 (Ø 12 mm - Beugel Ø 8 mm)	m3	21,373,000.00
5	Pasang BALOK LATAI 12/15 K. 175 (Ø 10 mm - Beugel Ø 6 mm)	m3	22,405,100.00
6	Pasang PLAT 12cm K. 175 (Ø 12 mm - Ø 10 mm)	m3	18,880,600.00
7	Membuat 1 m3 Beton mutu f'c = 7,4 Mpa (K100), slump (12 ± 2) cm, W/C = 0.87	m3	976,700.00
8	Membuat 1 m3 Beton mutu f'c = 9,8 Mpa (K125), slump (12 ± 2) cm, W/C = 0.78	m3	873,100.00
9	Membuat 1 m3 Beton mutu f'c = 12,2 Mpa (K150), slump (12 ± 2) cm, W/C = 0.72	m3	1,073,400.00
10	Membuat 1 m3 beton mutu f'c = 14,5 Mpa (K175), slump (12 ± 2) cm, W/C = 0.66	m3	1,123,700.00
11	Membuat 1 m3 beton mutu f'c = 16,9 Mpa (K200), slump (12 ± 2) cm, W/C = 0.61	m3	1,171,900.00
12	Membuat 1 m3 beton mutu f'c = 19,3 Mpa (K225), slump (12 ± 2) cm, W/C = 0.58	m3	1,207,500.00
13	Membuat 1 m3 beton mutu f'c = 21.7 Mpa (K250), slump (12 ± 2) cm, W/C = 0.56	m3	1,231,500.00
14	Membuat 1 m3 beton mutu f'c = 24.0 Mpa (K275), slump (12 ± 2) cm, W/C = 0.53	m3	1,272,600.00
15	Membuat 1 m3 beton mutu f'c = 26.4 Mpa (K300), slump (12 ± 2) cm, W/C = 0.52	m3	1,285,500.00
16	Membuat 1 m3 beton mutu f'c = 31.2 Mpa (K350), slump (12 ± 2) cm, W/C = 0.48	m3	1,387,400.00
17	Pembesian per 1 Kg Besi polos	kg	96,500.00
18	Memasang 1 m2 bekisting untuk pondasi	m2	181,200.00
19	Memasang 1 m2 Bekisting untuk Sloof	m2	181,200.00

20	Memasang 1 m2 Bekisting untuk Kolom	m2	269,300.00
	Memasang 1 m2 Bekisting untuk Kolom 2X PAKAI	m2	170,200.00
21	Memasang 1 m2 Bekisting untuk Balok	m2	278,300.00
22	Memasang 1 m2 bekisting untuk Lantai	m2	321,300.00
I	Pekerjaan Penutup Atap		
1	1 m2 pasang atap genteng pelentong kecil	m2	58,700.00
2	1 m2 pasang atap genteng kodok / glazzur	m2	133,700.00
3	1 m2 pasang atap genteng pelentong super / besar	m2	202,000.00
4	1 m2 pasang atap lama genteng kodok / glazzur	m2	133,700.00
5	1 m' pasang atap genteng bubung pelentong	m'	142,600.00
6	1 m' pasang bubung genteng kodok glazuur	m'	142,600.00
7	1 m' pasang bubung genteng pelentong besar	m'	126,500.00
8	1 m2 pasang atap Asbes Gelombang Besar (3.00 x 1.05 m) tebal 5 mm	m2	62,900.00
9	1 m2 pasang atap Asbes Gelombang Kecil (2.40 x 1.05 m) tebal 5 mm	m2	62,100.00
10	1 m2 pasang atap asbes gelombang (1.80 x 0.92) m x 5 mm	m2	38,600.00
11	1 m2 pasang atap asbes gelombang (3.00 x 1.05 m) x 4 mm	m2	42,200.00
12	1 m' pasang bubung stel gelombang 0.92 m	m'	392,300.00
13	1 m' pasang nok stel gelombang 1.05 m	m'	373,800.00
14	1 m' pasang nok stel gelombang 1.08 m	m'	373,100.00
15	1 m2 pasang atap genteng beton	m2	82,500.00
16	1 m2 pasang atap genteng metal	m2	120,900.00
17	1 m' pasang nok genteng beton	m'	109,200.00
18	Pekerjaan Pasang Talang pembuluh pipa PVC 3"	m'	160,500.00
	Pekerjaan Pasang Talang pembuluh pipa PVC 4 "	m'	245,500.00
19	10 m' Pekerjaan pasang talang Kotak PVC	m'	61,960.00
20	1 m2 pasang alumunium foil	m2	56,100.00
21	Atap Spandek	m2	57,500.00
22	Kalsiplank l = 30cm	m'	13,800.00
J	Pekerjaan Plafon + Partisi		

1	1 M2 pasang plafond (Gypsum tebal 12 mm) rangka METAL FURING	m2	226,300.00
2	1 M2 pasang plafond (Gypsum tebal 9 mm) rangka METAL FURING	m2	221,000.00
3	1 M2 pasang plafond (Gypsum tebal 12 mm) rangka HOLLOW 20/40	m2	101,600.00
4	1 M2 pasang plafond (Gypsum tebal 9 mm) rangka HOLLOW 20/40	m2	83,000.00
5	1 M2 pasang partisi (Gypsum tebal 12 mm) rangka metal stud 8cm	m2	179,800.00
6	1 M2 pasang partisi (Gypsum tebal 9 mm) rangka metal stud 8cm	m2	163,900.00
7	1 M2 pasang partisi (Gypsum tebal 12 mm) rangka hollow	m2	106,000.00
8	1 M2 pasang partisi (Gypsum tebal 9 mm) rangka hollow	m2	98,200.00
9	Memasang 1 m2 langit-langit Kalsiboard uk. (1200 x 2400 x 6)mm	m2	47,000.00
10	Memasang 1 m' list plafond gypsum profil	m'	34,200.00
11	Memasang 1 m' list langit-langit kayu profil	m'	19,600.00
12	Memasang 1 m2 rangka langit-langit (50x100)cm, kayu kelas II	m2	88,400.00
13	Memasang 1 m2 langit-langit asbes semen, tebal 4mm, 5mm dan 6mm	m2	86,800.00
K	Pekerjaan Sanitasi		
1	Memasang 1 buah KLOSET DUDUK / monoblok lengkap Setara KIA	bh	674,300.00
	Memasang 1 buah KLOSET DUDUK / monoblok lengkap Setara America Standart	bh	789,300.00
2	Memasang 1 buah Kloset Jongkok porselen Setara KIA	bh	443,700.00
3	Memasang 1 buah Urinoir	bh	2,043,700.00
4	Memasang 1 buah wastafel	bh	436,100.00
5	Memasang 1 buah Bak Kontrol pasangan batu bata ukuran (30 x 30) cm, tinggi 35cm	bh	442,100.00
6	Memasang 1 buah Bak Kontrol pasangan batu bata ukuran (45 x 45) cm, tinggi 50cm	bh	400,800.00
7	Memasang 1 buah bak kontrol pasangan batu bata ukuran (60 x 60) cm, tinggi 50cm	bh	609,700.00
8	Memasang 1 m' pipa PVC tipe AW diameter ½"	m'	30,700.00
9	Memasang 1 m' pipa PVC tipe AW diameter ¾"	m'	38,100.00
10	Memasang 1 m' pipa PVC tipe AW diameter 1"	m'	56,700.00
11	Memasang 1 m' pipa PVC tipe AW diameter 1½"	m'	96,200.00
12	Memasang 1 m' pipa PVC tipe AW diameter 2"	m'	122,300.00
13	Memasang 1 m' pipa PVC tipe AW diameter 2½"	m'	169,800.00
14	Memasang 1 m' pipa PVC tipe AW diameter 3"	m'	233,000.00
15	Memasang 1 m' pipa PVC tipe AW diameter 4"	bh	364,800.00

16	Memasang 1 buah kran diameter ¾" atau ½"	bh	32,800.00
17	Memasang 1 buah floor drain	bh	83,400.00
18	Memasang 1 m' Pipa GI Ø 4"	m'	741,700.00
19	Memasang 1 m' Pipa GI Ø 3"	m'	450,300.00
20	Memasang 1 m' Pipa GI Ø 1.5"	m'	135,100.00
21	Memasang 1 m' Pipa GI Ø 1"	m'	87,500.00
22	Membuat 1 Unit Septictank Uk. 200 x 100 x 125 cm	unit	6,917,800.00
23	Membuat 1 bh Sumur Resapan diameter 80 cm (rong), tinggi 2,5 m	bh	5,077,000.00
24	1 M' Pemasangan Saluran terbuka Buis Beton U 20 cm	m'	317,700.00
L Pekerjaan Besi dan Aluminium			
1	Memasang 1 Kg besi profil	kg	17,900.00
2	Membuat 1 m2 pintu besi plat baja tebal 2mm rangkap, rangka besi hollow	m2	715,900.00
3	Membuat 1 m2 Pagar Besi Hollow 40x40, 20x40	m2	655,700.00
4	Memasang 1 m kusen pintu aluminium	m'	247,400.00
5	Memasang 1 unit Kusen Pintu Temperd 12 mm P1	unit	1,123,600.00
6	Memasang 1 unit Kusen Pintu p2	unit	1,519,600.00
7	Memasang 1 unit Kusen Jendela J1 kaca Aluminium 4"	unit	5,483,100.00
8	Memasang 1 unit Kusen Jendela J1 kaca Aluminium 4"	unit	936,000.00
9	Memasang 1 unit Kusen Pintu P0 kaca Aluminium 4"	unit	3,970,800.00
16	Memasang 1 m2 Rangka Plapon metal firing uk.20.40.1.4 mm	m2	385,500.00
17	Memasang 1 unit Partisi type Pr.1	unit	717,000.00
18	Memasang 1 unit Partisi type Pr.2	unit	1,069,900.00
19	Memasang 1 unit Partisi type Pr.3	unit	1,148,300.00
29	Memasang 1 m2 jendela nako dan tralis	m2	640,100.00
30	Memasang 1 m' talang datar/jurai seng BJLS 28 lebar 90cm	m'	220,800.00
31	Memasang 1 m' talang ½ lingkaran D-15cm, seng plat BJLS 30 lebar 45cm	m'	98,400.00
32	Memasang 1 Unit Kusen Pintu-Jendela Type PJ 1	unit	4,206,300.00
33	Memasang 1 Unit Kusen Pintu Type P 1	unit	1,616,600.00
34	Memasang 1 Unit Kusen Pintu Type P 3	unit	2,376,600.00
35	Memasang 1 Unit Kusen Jendela Type J1	unit	1,526,100.00

36	Memasang 1 Unit Kusen Jendela Type BV 1	unit	224,600.00
37	Memasang 1 Unit Kusen Jendela Type BV 2	unit	296,200.00
38	Memasang 1 Unit Partisi Type PR 1	unit	717,000.00
39	Memasang 1 Unit Partisi Type PR 2	unit	1,069,900.00
40	Memasang 1 Unit Partisi Type PR 3	unit	1,148,300.00
41	Memasang 1 Unit Partisi Type PR 4	unit	1,179,600.00
42	Memasang 1 Unit Partisi Type PR 5	unit	481,900.00
43	Memasang 1 Unit Partisi Type PR 6	unit	3,216,000.00
44	Memasang 1 Unit Partisi Type PR 7	unit	2,512,300.00
45	Memasang 1 Unit Partisi Type PR 8	unit	15,346,600.00
46	Memasang 1 Unit Partisi Type PR 9	unit	5,354,500.00
47	Memasang 1 Unit Partisi Type PR 9'	unit	5,046,500.00
48	Memasang 1 Unit Partisi Type PR 10	unit	6,418,200.00
49	Memasang 1 Unit Partisi Type PR 11	unit	24,023,200.00
50	Memasang 1 M2 Relling Tangga	unit	4,256,500.00
M Pekerjaan Lantai			
1	Memasang 1 m2 Lantai Granit Uk. 60 x 60 cm	m2	204,500.00
2	Memasang 1 m2 Lantai Granit Uk. 40 x 40 cm	m2	227,400.00
3	Memasang 1 m2 lantai keramik uk 60 x 60 cm	m2	154,400.00
4	Memasang 1 m2 lantai keramik uk 40 x 40 cm	m2	141,200.00
5	Memasang 1 m2 lantai keramik 30 x 30 cm	m2	193,800.00
6	Memasang 1 m2 Dinding Keramik uk 25 x 40 cm	m2	259,700.00
7	Memasang 1 m2 lantai parquet kayu	m2	250,300.00
8	Memasang 1 m2 conblock paving abu-abu tebal 6cm (K-175)	m2	125,200.00
9	Memasang 1 m2 conblock paving abu-abu tebal 6cm (K-250)	m2	104,700.00
10	Memasang 1 m2 conblock paving abu-abu tebal 6cm (K-300)	m2	115,000.00
11	Memasang 1 m2 conblock paving abu-abu tebal 8cm (K-175)	m2	135,200.00
12	Memasang 1 m2 conblock paving abu-abu tebal 8cm (K-250)	m2	135,200.00
13	Memasang 1 m2 conblock paving abu-abu tebal 8cm (K-300)	m2	134,800.00
14	Memasang 1 m' Kanstin beton 15x30x40	M'	162,700.00

15	Memasang 1 m2 Lantai batu alam Uk. 40 x 60 cm	m2	234,600.00
N Pekerjaan Pengecatan			
1	Mengikis/mengerok 1 m2 permukaan cat tembok lama	m2	9,900.00
2	Mengecat 1 m2 bidang kayu lama	m2	23,500.00
3	1 m2 Pengecatan bidang kayu baru (1 lapis plamir, 1 lapis cat dasar, 2 lapis cat penutup)	m2	26,300.00
4	1 m2 Pengecatan bidang kayu baru (1 lapis plamir, 1 lapis cat dasar, 3 lapis cat penutup)	m2	36,000.00
5	1 m2 Pelaburan bidang kayu dengan teak oil	m2	13,300.00
6	1 m2 Pelaburan bidang kayu dengan politur	m2	49,700.00
7	1 m2 Pengecatan Tembok baru (1 lapis plamir, 1 lapis cat dasar, 2 lapis cat penutup)		
	Catilac INTERIOR	m2	19,600.00
8	1 m2 Pengecatan Tembok baru EXTERIOR (1 lapis plamir, 1 lapis cat dasar, 2 lapis cat penutup)		
	Propan/mowilex --> exterior	m2	24,400.00
9	1 m2 Pengecatan Tembok lama EXTERIOR (1 lapis plamir, 1 lapis cat dasar, 2 lapis cat penutup)		
	Propan/mowilex --> exterior	m2	18,900.00
10	1 m2 Pengecatan Plafond (1 lapis plamir, 1 lapis cat dasar, 2 lapis cat penutup)		
	Catilac INTERIOR	m2	19,600.00
11	pelapisan 1 m2 mortar	m2	12,800.00
12	1 m2 Pengecatan Tembok lama (1 lapis cat dasar, 2 lapis cat penutup)	m2	15,700.00
13	1 m2 Wallpaper "STANDART"	m2	75,000.00
14	1 m2 Wallpaper "DELUXE"	m2	37,000.00
15	1 m2 Pengecatan Genteng (1 lapis cat dasar, 2 lapis cat penutup)	m2	15,700.00
16	1 m2 Pengecatan permukaan baja dengan meni besi	m2	20,000.00
17	1 m2 Pengecatan permukaan besi/baja (1 lapis meni besi, 2 lapis cat penutup)	m2	37,700.00
18	1 m2 Pengecatan Eternit baru (1 lapis plamir, 1 lapis cat dasar, 2 lapis cat penutup)	m2	22,900.00
O Pekerjaan Kunci dan Kaca			
1	1 buah Pasang kunci pintu 2x putar	bh	160,600.00
2	1 buah Pasang kunci pintu 1x putar	bh	136,800.00
3	1 set Pasang engsel pintu	set	42,600.00
4	1 set Pasang engsel jendela	set	8,400.00

5	1 set Pasang Hak angin maju mundur	set	16,200.00
6	1 m2 Pasang kaca tebal 3mm bening	m2	109,400.00
7	1 m2 Pasang kaca tebal 5mm bening	m2	150,100.00
8	1 m2 Pasang kaca Rayban tebal 5 mm	m2	90,700.00
9	1 m2 Pasang kaca eS tebal 5 mm	m2	216,100.00
10	1 buah Pasang grendel tanam jendela	bh	15,400.00
11	1 buah Pasang grendel tanam pintu	bh	15,400.00
12	1 buah Pasang grendel tanam pintu	bh	68,400.00
13	1 m2 Pasang Kawat Harmonika	m2	72,100.00
P	Pekerjaan Listrik		
1	Memasang 1 bh Titik Lampu	bh	207,600.00
2	Memasang 1 Titik Stop Kontak	ttk	79,900.00
3	Memasang 1 Set Panel Box	set	671,300.00
4	Memasang 1 Set lampu TL 1 x 20 Watt	set	148,500.00
5	Memasang 1 Set lampu TL 1 x 40 Watt	set	181,500.00
6	Memasang 1 Set armatur lampu pijar 25 Watt	set	22,000.00
7	Memasang 1 Set armatur lampu 2x20 W Full Reflektor	set	99,800.00
8	Memasang 1 Set armatur lampu Downlight 1 x 20 w	set	20,500.00
9	Memasang AC. Window 2 PK Ex Jepang	set	15,450,800.00
10	Memasang AC. Window 1,5 PK Ex Jepang	set	8,241,000.00
11	Memasang AC. Window 1 PK Ex Jepang	set	7,209,300.00
12	Memasang AC. Ceiling 1/2 PK Ex Jepang	set	4,193,800.00
13	Memasang Exhaust Fan Ex Jepang	bh	1,131,700.00
14	Memasang kipas angin gantung Ex Jepang	bh	948,700.00

5. Rencana Anggaran Biaya



RENCANA ANGGARAN BIAYA (RAB)

PEKERJAAN : PEMBANGUNAN GEDUNG AKUNTANSI FAKULTAS EKONOMI UNIVERSITAS JEMBER
 LOKASI : UNIVERSITAS JEMBER
 TAHUN : 2017

No	JENIS PEKERJAAN	Sat.	Volume	Harga sat.	JUMLAH
I	<u>PEKERJAAN PERSIAPAN</u>				
1	Pekerjaan Pembersihan dan pemerataan	Ls	450.00	10,500.00	4,725,000.00
2	Pekerjaan pasang bouwplank	m'	79.60	69,400.00	5,524,240.00
				Jumlah	10,249,240.00
II	<u>PEKERJAAN TANAH</u>				
1	Galian Tanah Pondasi Batukali menerus	m ³	96.11	50,700.00	4,872,903.75
2	Galian Tanah Pondasi Poer Type P1	m ³	131.60	62,100.00	8,172,360.00
3	Galian Tanah Pondasi Poer Type P2	m ³	77.11	62,100.00	4,788,492.19
4	Urugan tanah bawah lantai	m ³	68.69	95,000.00	6,525,692.50
5	Urugan tanah kembali	m ³	174.93	36,500.00	6,384,956.41
6	Urugan pasir bawah pondasi menerus & pondasi setempat	m ³	24.73	106,700.00	2,638,424.25
7	Urugan pasir bawah lantai	m ³	34.35	106,700.00	3,664,691.53
				Jumlah	37,047,520.62
III	<u>PEKERJAAN PONDASI</u>				
1	Pasang Aanstamping	m ³	36.28	283,100.00	10,270,868.00
2	Pasang Pondasi batukali 1 PC : 4 PP	m ³	-	728,400.00	-
				Jumlah	10,270,868.00
IV	<u>PEKERJAAN BETON</u>				
A	<u>LANTAI 1</u>				
1	Lantai Kerja bawah pondasi setempat tb. 5 cm	m ³	4.52	1,030,800.00	4,657,927.50

2	Rabat Beton Bawah lantai tb. 5 cm	m ³	17.17	1,030,800.00	17,701,799.55
3	Beton Pondasi Poer Type 1	m ³	14.40	2,536,900.00	36,531,360.00
4	Beton Pondasi Poer Type 2	m ³	9.84	2,536,900.00	24,972,609.38
5	Beton Kolom Pondasi Tangga 15x135 cm	m ³	0.24	4,493,000.00	1,091,799.00
6	Beton Kolom Praktis 11x11 cm	m'	38.12	55,900.00	2,130,908.00
7	Beton Kolom 40x60 cm	m ³	18.29	3,566,800.00	65,229,638.40
8	Beton Kolom 30x40 cm	m ³	16.00	4,493,000.00	71,896,986.00
9	Beton Sloof 20/40	m ³	8.71	3,156,500.00	27,499,428.00
10	Beton Balok Latai 11/20	m ³	1.47	3,383,800.00	4,972,832.48
11	Beton Plat dan Trap Tangga Lt.1 - Lt.2	m ³	2.43	2,238,800.00	5,448,343.68
12	Beton Balok 20/40 Tangga Lt.1 - Lt.2	m ³	0.20	2,858,500.00	574,558.50
13	Beton Gantung Teras 12/30	m ³	0.92	2,858,500.00	2,634,393.60
				Jumlah A	265,342,584.09
B	LANTAI 2				
1	Beton Balok Latai 11/20	m ³	2.20	3,383,800.00	7,440,637.82
2	Beton Kolom Praktis 11x11 cm	m'	40.95	55,900.00	2,289,105.00
3	Beton Kolom 40x60 cm	m ³	16.85	3,566,800.00	60,093,446.40
4	Beton Kolom 30x40 cm	m ³	2.95	4,493,000.00	13,263,336.00
5	Beton Balok Induk 35/75	m ³	21.58	2,797,600.00	60,365,214.00
6	Beton Balok Anak 20/40	m ³	9.92	2,858,500.00	28,356,320.00
7	Beton Balok Anak 11/20	m ³	0.22	3,383,800.00	750,391.49
8	Beton Balok Latei 11/20	m ³	1.36	3,383,800.00	4,600,614.48
9	Beton Plat dan Trap Tangga Lt.1 - Lt.2	m ³	2.43	2,238,800.00	5,448,343.68
10	Beton Ring Balk 12/15 cm Pagar Teras	m'	0.49	2,858,500.00	1,391,374.88
11	Beton Plat Lantai 2 tb.12 cm	m ³	30.11	2,238,800.00	67,400,417.28
12	Balok Gantung Teras 12/30	m ³	1.06	2,858,500.00	3,025,436.40
				Jumlah B	254,424,637.42
C	LANTAI 3				
1	Beton Balok Latai 11/20	m ³	2.20	3,383,800.00	7,440,637.82

2	Beton Kolom Praktis 11x11 cm	m ³	40.95	55,900.00	2,289,105.00
3	Beton Kolom 40x60 cm	m ³	17.71	3,566,800.00	63,175,161.60
4	Beton Kolom 30x40 cm	m ³	4.43	4,493,000.00	19,895,004.00
5	Beton Balok Induk 35x75 cm	m ³	14.81	2,797,600.00	41,418,468.00
6	Beton Balok Anak 20/40	m ³	20.76	2,858,500.00	59,342,460.00
7	Beton Balok Anak 11/20	m ³	0.22	3,383,800.00	750,391.49
8	Beton Balok Latei 11/20	m ³	1.36	3,383,800.00	4,600,614.48
9	Beton Plat Lantai tb.12 cm	m ³	30.11	2,238,800.00	67,400,417.28
10	Balok Gantung Teras 12/30.	m ³	1.06	2,858,500.00	3,035,727.00
11	Ring Balk 20x40	m ³	5.34	2,858,500.00	15,275,824.00
12	Ring Balk 11x20	m ³	0.53	3,383,800.00	1,790,706.96
13	Ring Balk Pagar Teras 12/15	m ³	0.49	2,858,500.00	1,391,374.88
14	Beton Plat Dudukan Tandon Air Tbl. 10 cm	m ³	0.96	2,238,800.00	2,154,688.28
				Jumlah C	289,960,580.79
				Jumlah IV	809,727,802.30
V	PEKERJAAN ATAP				
1	Pasang Base Plat Tebal 12 mm	Kg	124.34	8,000.00	994,752.00
2	Pasang Kolom Baja WF 200.100.5,5.8	Kg	1,408.00	8,000.00	11,264,000.00
3	Pasang Kuda-Kuda Baja WF 200.100.5,5.8	Kg	3,263.57	8,000.00	26,108,586.67
4	Pasang Ex Baja WF 200.100.5,5.8	Kg	106.67	8,000.00	853,333.33
5	Pasang Konsol Baja WF 150.75.5.7	Kg	924.00	8,000.00	7,392,000.00
6	Pasang Ex Baja WF 150.75.5.7	Kg	546.00	8,000.00	4,368,000.00
7	Pasang Plat Buhul 10 mm	Kg	587.87	8,000.00	4,702,966.40
8	Pasang Plat Pengaku 6 mm	Kg	38.85	8,000.00	310,803.48
9	Pasang Ikatan Angin Besi 16 mm	Kg	169.62	11,500.00	1,950,591.71
10	Pasang Trekstang Besi 12 mm	Kg	150.67	11,500.00	1,732,755.68
11	Pasang Batang Tarik 19 mm	Kg	189.20	11,500.00	2,175,798.50
12	Pasang Konstruksi Gording C 150.50.20.2,3	Kg	2,287.40	13,800.00	31,566,175.20
13	Pas. Besi Siku 100.100.10 penahan gording	Kg	244.62	13,800.00	3,375,756.00
14	Pasang Usuk dan Reng Galvalume	M2	599.34	304,100.00	182,258,533.75

15	Papan Rueter kayu 2/20	M3	52.12	32,600.00	1,699,112.00
16	Pasang Atap Genteng Model Plentong Besar	M2	599.34	202,000.00	121,066,175.00
17	Pasang Bubung Sejenis	M'	52.12	126,500.00	6,593,180.00
18	Pas. Talang Datar Seng Bj.LS. 30	M'	108.60	220,800.00	23,978,880.00
19	Pas. Talang Tegak PVC Ø 3"	M'	115.15	160,500.00	18,481,575.00
				Jumlah	450,872,974.73
VI	PEKERJAAN PENANGKAL PETIR				
1	Pengadaan Penangkal petir V-6 (Radius 60 mtr)	Bh	2.00	1,750,000.00	3,500,000.00
2	Kabel BC70mm ² +Pipa Galvanis 3/4"	mtr	40.57	200,000.00	8,114,000.00
3	Dudukan tiang penangkal petir	Bh	2.00	750,000.00	1,500,000.00
4	Pipa Ø 1", (6 mtr)	Bh	1.00	400,000.00	400,000.00
5	Bak kontrol grounding lengkap (45 x 45 cm)	Bh	1.00	400,800.00	400,800.00
6	Ijin DEPNAKER	Ls	1.00	3,500,000.00	3,500,000.00
7	Material bantu	Ls	1.00	750,000.00	750,000.00
				Jumlah XIII	18,164,800.00
					16,128,400.00
VII	PEKERJAAN PASANGAN				
A	LANTAI 1				
1	Pas. Bata merah 1/2 Bata camp. 1 : 3	m ²	75.12	90,700.00	6,813,746.80
2	Pas. Bata merah 1/2 Bata camp. 1 : 5	m ²	292.59	82,100.00	24,021,327.02
				Jumlah	30,835,073.82
B	LANTAI 2				
1	Pas. Bata merah 1/2 Bata camp. 1 : 3	m ²	40.38	90,700.00	3,662,738.10
2	Pas. Bata merah 1/2 Bata camp. 1 : 5	m ²	301.60	82,100.00	24,761,466.73
				Jumlah	28,424,204.83
C	LANTAI 3				
1	Pas. Bata merah 1/2 Bata camp. 1 : 3	m ²	40.38	90,700.00	3,662,738.10
2	Pas. Bata merah 1/2 Bata camp. 1 : 5	m ²	327.82	82,100.00	26,913,882.43
				Jumlah	3,662,738.10
				Jumlah II	62,922,016.75

VIII	PEKERJAAN PLESTERAN				
A	LANTAI 1				
1	Pekerjaan Plesteran 1 : 3	m ²	150.25	51,000.00	7,662,648.00
2	Pekerjaan Plesteran 1 : 6	m ²	585.17	44,900.00	26,274,240.76
3	Pekerjaan Acian	m ²	120.01	28,000.00	3,360,280.00
4	Pekerjaan Benangan 1 : 2	m'	820.68	15,100.00	12,392,268.00
				Jumlah	49,689,436.76
B	LANTAI 2				
1	Pekerjaan Plesteran 1 : 3	m ²	80.77	51,000.00	4,119,066.00
2	Pekerjaan Plesteran 1 : 6	m ²	603.20	44,900.00	27,083,796.74
3	Pekerjaan Acian	m ²	159.61	28,000.00	4,469,080.00
4	Pekerjaan Benangan 1 : 2	m ²	718.76	15,100.00	10,853,276.00
				Jumlah	46,525,218.74
C	LANTAI 3				
1	Pekerjaan Plesteran 1 : 3	m ²	80.77	51,000.00	4,119,066.00
2	Pekerjaan Plesteran 1 : 6	m ²	655.64	44,900.00	29,438,083.34
3	Pekerjaan Acian	m ²	83.21	28,000.00	2,329,880.00
4	Pekerjaan Benangan 1 : 2	m ²	735.08	15,100.00	11,099,708.00
				Jumlah	46,986,737.34
				Jumlah III	143,201,392.84
IX	PEKERJAAN KUSEN, DAUN PINTU JENDELA DAN PENGUNCI				
A	LANTAI 1				
1	Pas. Kusen Aluminium 4" Type PJ1	Unit	2.00	4,206,300.00	8,412,600.00
2	Pas. Kusen Aluminium 4" Type P1	Unit	15.00	1,616,600.00	24,249,000.00
3	Pas. Kusen Aluminium 4" Type P2	Unit	3.00	1,519,600.00	4,558,800.00
4	Pas. Kusen Aluminium 4" Type J1	Unit	10.00	1,526,100.00	15,261,000.00
5	Pas. Kusen Aluminium 4" Type BV 1	Unit	2.00	224,600.00	449,200.00
6	Pas. Kusen Aluminium 4" Type BV 2	Unit	1.00	296,200.00	296,200.00
7	Pas. Kusen Pintu Shaft	Unit	1.00	999,800.00	999,800.00
8	Dinding Partisi Rangka Aluminium 4" Type Pr1	Unit	40.00	717,000.00	28,680,000.00

9	Dinding Partisi Rangka Aluminium 4" Type Pr2	Unit	44.00	1,069,900.00	47,075,600.00
10	Dinding Partisi Rangka Aluminium 4" Type Pr3	Unit	10.00	1,148,300.00	11,483,000.00
11	Dinding Partisi Rangka Aluminium 4" Type Pr4	Unit	2.00	1,179,600.00	2,359,200.00
12	Dinding Partisi Rangka Aluminium 4" Type Pr5	Unit	4.00	481,900.00	1,927,600.00
13	Pek. Reilling Tangga	m ²	8.58	4,256,500.00	36,520,770.00
				Jumlah	182,272,770.00
B	LANTAI 2				
1	Pas. Kusen Aluminium 4" Type PJ 1	Unit	2.00	4,206,300.00	8,412,600.00
2	Pas. Kusen Aluminium 4" Type P1	Unit	1.00	1,616,600.00	1,616,600.00
3	Pas. Kusen Aluminium 4" Type P2	Unit	1.00	1,519,600.00	1,519,600.00
4	Pas. Kusen Aluminium 4" Type J1	Unit	7.00	1,526,100.00	10,682,700.00
5	Pas. Kusen Aluminium 4" Type BV1	Unit	7.00	224,600.00	1,572,200.00
6	Pas. Kusen Aluminium 4" Type BV2	Unit	6.00	296,200.00	1,777,200.00
7	Pas. Kusen Pintu Shaft	Unit	1.00	999,800.00	999,800.00
8	Dinding Partisi Rangka Alumunium 4" Type Pr6	Unit	8.00	3,216,000.00	25,728,000.00
9	Dinding Partisi Rangka Alumunium 4" Type Pr7	Unit	6.00	2,512,300.00	15,073,800.00
10	Dinding Partisi Rangka Alumunium 4" Type Pr8	Unit	2.00	15,346,600.00	30,693,200.00
11	Dinding Partisi Rangka Alumunium 4" Type Pr9	Unit	3.00	5,354,500.00	16,063,500.00
12	Dinding Partisi Rangka Alumunium 4" Type Pr9'	Unit	1.00	5,046,500.00	5,046,500.00
13	Dinding Partisi Rangka Alumunium 4" Type Pr10	Unit	3.00	6,418,200.00	19,254,600.00
14	Pek. Reilling Tangga	m ²	8.58	4,256,500.00	36,520,770.00
				Jumlah	174,961,070.00
C	LANTAI 3				
1	Pas. Kusen Aluminium 4" Type P1	Unit	1.00	1,616,600.00	1,616,600.00
2	Pas. Kusen Aluminium 4" Type P2	Unit	3.00	1,519,600.00	4,558,800.00
3	Pas. Kusen Aluminium 4" Type P3	Unit	2.00	2,376,600.00	4,753,200.00
4	Pas. Kusen Pintu Shaft	Unit	1.00	999,800.00	999,800.00
5	Pas. Kusen Aluminium 4" Type J1	Unit	12.00	1,526,100.00	18,313,200.00
6	Pas. Kusen Aluminium 4" Type BV1	Unit	2.00	224,600.00	449,200.00
7	Pas. Kusen Aluminium 4" Type BV2	Unit	1.00	296,200.00	296,200.00
7	Dinding Partisi Rangka Alumunium 4" Type Pr11	Unit	1.00	24,023,200.00	24,023,200.00

					55,010,200.00
				Jumlah IV	412,244,040.00
X	PEKERJAAN LANTAI & KERAMIK				
A	LANTAI 1				
1	Keramik Lantai 60/60 cm	m ²	343.69	154,400.00	53,065,041.20
2	Keramik Dinding KM 25/40	m ²	28.77	259,700.00	7,471,569.00
3	Keramik Lantai KM/WC 30/30 kasar	m ²	5.94	205,600.00	1,221,778.00
4	Keramik Meja Beton 30/30	m ²	1.97	193,800.00	380,817.00
5	Keramik Dinding Meja Beton 25/40	m ²	3.18	259,700.00	826,495.25
				Jumlah	62,965,700.45
B	LANTAI 2				
1	Keramik Lantai 60/60 cm	m ²	333.66	154,400.00	51,517,181.20
2	Keramik Lantai KM/WC 30/30 kasar	m ²	5.94	205,600.00	1,221,778.00
3	Keramik Dinding 25/40	m ²	28.77	259,700.00	7,471,569.00
				Jumlah	60,210,528.20
C	LANTAI 3				
1	Keramik Lantai 60/60 cm	m ²	317.14	154,400.00	48,965,644.00
2	Keramik Lantai KM/WC 30/30 kasar	m ²	5.94	205,600.00	1,221,778.00
3	Keramik Dinding 25/40	m ²	28.77	259,700.00	7,471,569.00
					57,658,991.00
				Jumlah V	180,835,219.65
XI	PEKERJAAN PLAFOND				
A	LANTAI 1				
1	Plafond Rangka Hollow + Penutup Gypsum board (1200x2400x9)	m ²	321.92	83,000.00	26,719,360.00
2	List Plafond Gypsum	m'	165.20	34,200.00	5,649,840.00
				Jumlah	32,369,200.00
B	LANTAI 2				
1	Plafond Rangka Hollow + Penutup Gypsum board (1200x2400x9)	m ²	319.97	83,000.00	26,557,510.00

2	List Plafond Gypsum	m'	309.08	34,200.00	10,570,536.00
				Jumlah	37,128,046.00
C	LANTAI 3				
1	Plafond Rangka Hollow + Penutup Gypsum board (120x240 cm)	m ²	447.15	83,000.00	37,113,242.50
2	List Plafond Gypsum	m'	215.52	34,200.00	7,370,784.00
					44,484,026.50
				Jumlah VI	113,981,272.50
XII	PEKERJAAN PENGECATAN				
A	LANTAI 1				
1	Cat Dinding	m ²	855.43	19,600.00	16,766,435.84
2	Cat Plafond	m ²	321.92	22,900.00	7,371,968.00
				Jumlah	24,138,403.84
B	LANTAI 2		347.20		
1	Cat Dinding	m ²	843.58	19,600.00	16,534,140.56
2	Cat Plafond	m ²	319.97	22,900.00	7,327,313.00
3	Cat Waterproof Plat Lantai KM/WC	m ²	11.50	12,800.00	147,200.00
				Jumlah	24,008,653.56
C	LANTAI 3				
1	Cat Dinding	m ²	819.61	19,600.00	16,064,406.96
2	Cat Plafond	m ²	447.15	22,900.00	10,239,677.75
3	Cat Kalsiplank	m ²	422.40	19,600.00	8,279,040.00
4	Cat Waterproof Plat Lantai dan Dudukan Tandon	m ²	23.00	12,800.00	294,400.00
				Jumlah	34,877,524.71
				Jumlah VII	83,024,582.11
XIII	PEKERJAAN INSTALASI SANITAIR DAN INST. AIR				
A	LANTAI 1				
1	Pas. Pipa PVC Ø 3/4"	m'	29.90	38,100.00	1,139,190.00
2	Pas. Pipa PVC Ø 1,5"	m'	4.50	96,200.00	432,900.00

3	Pas. Pipa PVC Ø 2,5"	m'	9.00	169,800.00	1,528,200.00
4	Pas. Pipa PVC Ø 3"	m'	41.17	233,000.00	9,592,610.00
5	Pas. Pipa PVC Ø 4"	m'	13.68	364,800.00	4,990,464.00
6	Jet Spry	bh	3.00	125,000.00	375,000.00
7	Kran Air	bh	5.00	32,800.00	164,000.00
8	Closet Duduk Monoblock ex KIA	bh	3.00	674,300.00	2,022,900.00
9	Floor Drain	bh	3.00	83,400.00	250,200.00
10	Wastafel	bh	2.00	436,100.00	872,200.00
11	Bak Cuci Stenlessteel	bh	1.00	413,000.00	413,000.00
12	Septicktank	Ls	2.00	6,917,800.00	13,835,600.00
13	Sumur Resapan	Unit	2.00	5,077,000.00	10,154,000.00
14	Pasang Jet Pump 1,5 PK	bh	1.00	2,500,000.00	2,500,000.00
15	Sumur Air Bersih	Unit	1.00	4,250,000.00	4,250,000.00
16	Saluran Terbuka Buis Beton U 20 cm	m'	48.90	317,700.00	15,535,530.00
17	Bak Kontrol 30 x 30 cm	bh	7.00	442,100.00	3,094,700.00
				Jumlah	71,150,494.00
B	LANTAI 2				
1	Pas. Pipa PVC Ø 3/4"	m'	13.68	38,100.00	521,208.00
2	Pas. Pipa PVC Ø 1,5"	m'	2.40	96,200.00	230,880.00
3	Pas. Pipa PVC Ø 2,5"	m'	6.90	169,800.00	1,171,620.00
4	Pas. Pipa PVC Ø 3"	m'	50.07	233,000.00	11,666,682.80
5	Pas. Pipa PVC Ø 4"	m'	10.02	364,800.00	3,655,296.00
6	Jet Spry	bh	3.00	125,000.00	375,000.00
7	Kran Air	bh	5.00	32,800.00	164,000.00
8	Closet Duduk Monoblock ex. KIA	bh	3.00	674,300.00	2,022,900.00
9	Flour Drain	bh	3.00	83,400.00	250,200.00
10	Wastafel	bh	2.00	436,100.00	872,200.00
				Jumlah	20,929,986.80
C	LANTAI 3				
1	Pas. Pipa PVC Ø 3/4"	m'	13.68	38,100.00	521,208.00
2	Pas. Pipa PVC Ø 1,5"	m'	2.40	96,200.00	230,880.00

3	Pas. Pipa PVC Ø 2,5"	m'	6.90	169,800.00	1,171,620.00
4	Pas. Pipa PVC Ø 3"	m'	50.07	233,000.00	11,666,682.80
5	Pas. Pipa PVC Ø 4"	m'	10.02	364,800.00	3,655,296.00
6	Jet Spry	bh	3.00	125,000.00	375,000.00
7	Kran Air	bh	5.00	32,800.00	164,000.00
8	Closet Duduk Monoblock ex. KIA	Unit	3.00	674,300.00	2,022,900.00
9	Flour Drain	bh	3.00	83,400.00	250,200.00
10	Wastafel	bh	2.00	436,100.00	872,200.00
11	Tandon Air Kapasitas 1.000 ltr.	bh	1.00	1,400,000.00	1,400,000.00
				Jumlah	22,329,986.80
				Jumlah VIII	114,410,467.60
XIV	PEKERJAAN AIR HUJAN				
1	Pas. Talang Tegak PVC 3"	m'	115.15	233,000.00	26,829,950.00
2	Pas. Saluran terbuka buis beton U 20 cm	m'	48.90	317,700.00	15,535,530.00
3	Pas. Bak kontrol 30x30 cm	bh	7.00	442,100.00	3,094,700.00
				Jumlah IX	45,460,180.00
XV	PEKERJAAN LISTRIK				
A	LANTAI 1				
1	Pek. Instalasi Listrik	Ttk	70.00	207,600.00	14,532,000.00
2	Pas. Lampu TL. LED 2 x 9 Watt Full Reflektor	Bh	28.00	522,400.00	14,627,200.00
3	Pas. Lampu LED 13 Watt	Bh	5.00	110,100.00	550,500.00
4	Pas. Lampu Downlight LED 13 Watt	Bh	5.00	181,500.00	907,500.00
5	Pas. Lampu Baret LED 13 watt	Bh	1.00	132,000.00	132,000.00
6	Pas. ExHouse Fan	Bh	3.00	1,131,700.00	3,395,100.00
7	Pas. Stop Kontak 1 phase	Bh	16.00	79,900.00	1,278,400.00
8	Pas. Stop Kontak 1 phase (untuk AC+ steker)	Bh	12.00	79,900.00	958,800.00
9	Pas. Panel Box MCB Lt.1	Bh	1.00	671,300.00	671,300.00
10	Pas. Panel Box SDP	Bh	1.00	4,000,000.00	4,000,000.00
11	Pas. Panel Box MDP	Bh	1.00	4,800,000.00	4,800,000.00
12	Pas. Panel Box AC	Bh	1.00	4,800,000.00	4,800,000.00
13	Pasang Kabel NYY 4 x 16 mm dari SDP ke MDP	M1	29.00	125,000.00	3,625,000.00

14	Pasang Kabel NYY 4 x 25 mm dari Meter ke Panel	M1	14.00	140,000.00	1,960,000.00
15	Pasang Kabel Arde BC 16 mm	M1	3.95	45,000.00	177,750.00
16	Pasang Arde Panel	Bh	1.00	175,000.00	175,000.00
17	Pengadaan dan pemasangan kabel twisted 3 x 95 mm + 1 x 70 mm	M1	150.00	154,000.00	23,100,000.00
18	Pengadaan dan pemasangan material bantu				
17.1.	Service dan breacket (inc.stainless steel,pin)	Set	12.00	91,000.00	1,092,000.00
17.2.	Suspension dan breacket (inc.stainless steel,pin)	Set	4.00	84,000.00	336,000.00
17.3.	Gay wire (tracsukur) dan galian	Titik	3.00	840,000.00	2,520,000.00
17.4.	Skun AL/CU 95 mm dan isolasi	M1	6.00	91,000.00	546,000.00
17.5.	Skun AL/CU 70 mm dan isolasi	M1	2.00	63,000.00	126,000.00
17.6.	Aseessories (klem 2",paku,ties kable),	Set	1.00	2,000,000.00	2,000,000.00
17.7.	Pengadaan dan pemasangan panel KWH meter	Set	1.00	7,700,000.00	7,700,000.00
				Jumlah	94,010,550.00
B	LANTAI 2				
1	Pek. Instalasi Listrik	Ttk	79.00	207,600.00	16,400,400.00
2	Pas. Lampu TL. LED 2 x 9 watt Full Reflektor	Bh	15.00	522,400.00	7,836,000.00
3	Pas. Lampu LED. 18 Watt	Bh	5.00	110,100.00	550,500.00
4	Pas. Lampu Downlight LED 13 Watt	Bh	32.00	181,500.00	5,808,000.00
5	Pas. Lampu Baret LED 13 Watt	Bh	1.00	132,000.00	132,000.00
6	Pas. Exhaust Fan	Bh	3.00	1,131,700.00	3,395,100.00
7	Pas. Stop Kontak 1 phase	Bh	19.00	79,900.00	1,518,100.00
8	Pas. Stop Kontak 1 phase (untuk AC+ steker)	Bh	4.00	79,900.00	319,600.00
9	Pas. Panel Box SDP	Bh	1.00	4,000,000.00	4,000,000.00
10	Pas. Panel Box MCB Lt.2	Bh	1.00	671,300.00	671,300.00
11	Pas. Panel Box AC	Bh	1.00	4,800,000.00	4,800,000.00
				Jumlah	45,431,000.00
C	LANTAI 3				
1	Pek. Instalasi Listrik	Ttk	40.00	207,600.00	8,304,000.00
2	Pas. Lampu TL. LED 2 x 9 watt Full Reflektor	Bh	28.00	522,400.00	14,627,200.00
3	Pas. Lampu LED. 13 Watt	Bh	5.00	110,100.00	550,500.00
4	Pas. Lampu Downlight LED 13 Watt	Bh	5.00	181,500.00	907,500.00

5	Pas. Lampu Baret LED 13	Bh	1.00	132,000.00	132,000.00
6	Pas. Exhaust Fan	Bh	3.00	1,131,700.00	3,395,100.00
7	Pas. Stop Kontak 1 phase	Bh	16.00	79,900.00	1,278,400.00
8	Pas. Stop Kontak 1 phase (untuk AC+ steker)	Bh	11.00	79,900.00	878,900.00
9	Pas. Panel Box SDP	Bh	1.00	4,000,000.00	4,000,000.00
10	Pas. Panel Box MCB	Bh	1.00	671,300.00	671,300.00
11	Pas. Panel Box AC	Bh	1.00	4,800,000.00	4,800,000.00
					39,544,900.00
				Jumlah	178,986,450.00
C	KABEL FEEDER				
1	Kabel NYY 4x35mm ² , Dari Panel SDP lantai 1 ke KWH	m'	8.00	250,000.00	2,000,000.00
2	Kabel NYY 4x25mm ² , Dari Panel SDP lantai 2 ke SDP Lantai 1	m'	4.50	180,000.00	810,000.00
3	Kabel NYY 4x25mm ² , Dari Panel SDP lantai 3 ke SDP Lantai 2	m'	4.50	180,000.00	810,000.00
4	Kabel BC 25mm ² , Dari Panel SDP lantai 1 ke Bak Kontrol	m'	5.00	55,000.00	275,000.00
				Jumlah	3,895,000.00
				Jumlah X	182,881,450.00
XVI	PEKERJAAN INSTALASI FIRE ALARM				
A	LANTAI 1				
1	Pasang Titik Instalasi+Acessorries ROR Detektor		1.00	250,000.00	250,000.00
2	Pasang Titik Instalasi+Acessorries Smoke Detektor		12.00	250,000.00	3,000,000.00
3	Pasang Titik Instalasi+Acessorries Bell Alarm		1.00	250,000.00	250,000.00
				Jumlah	3,500,000.00
B	LANTAI 2				
1	Pasang Titik Instalasi+Acessorries ROR Detektor		1.00	250,000.00	250,000.00
2	Pasang Titik Instalasi+Acessorries Smoke Detektor		14.00	250,000.00	3,500,000.00
3	Pasang Titik Instalasi+Acessorries Bell Alarm		1.00	250,000.00	250,000.00
				Jumlah	4,000,000.00
C	LANTAI 3				
1	Pasang Titik Instalasi+Acessorries ROR Detektor		1.00	250,000.00	250,000.00
2	Pasang Titik Instalasi+Acessorries Smoke Detektor		12.00	250,000.00	3,000,000.00
3	Pasang Titik Instalasi+Acessorries Bell Alarm		1.00	250,000.00	250,000.00

				Jumlah	3,500,000.00
				Jumlah XI	11,000,000.00
XVII	PEKERJAAN INSTALASI KABEL TRY				
1	Pasang Penggantung + Accesories Kabel Tray Arus Kuat dan Lemah Lantai 1	m'	28.65	255,000.00	7,305,750.00
2	Pasang Penggantung + Accesories Kabel Tray Arus Kuat dan Lemah Lantai 2	m'	28.65	255,000.00	7,305,750.00
3	Pasang Penggantung + Accesories Kabel Tray Arus Kuat dan Lemah Lantai 3	m'	28.65	255,000.00	7,305,750.00
				Jumlah XII	21,917,250.00
XVIII	PEKERJAAN JARINGAN KOMPUTER DAN ITERNET				
A	LANTAI 1				
	Pasang Titik Instalasi + Accessories Komputer	Ttk	42.00	250,000.00	10,500,000.00
	Pasang Titik Instalasi + Accessories Internet	Ttk	42.00	250,000.00	10,500,000.00
				Jumlah	21,000,000.00
B	LANTAI 2				
	Pasang Titik Instalasi + Accessories Komputer	Ttk	4.00	250,000.00	1,000,000.00
	Pasang Titik Instalasi + Accessories Internet	Ttk	4.00	250,000.00	1,000,000.00
				Jumlah	2,000,000.00
C	LANTAI 3				
	Pasang Titik Instalasi + Accessories Komputer	Ttk	4.00	250,000.00	1,000,000.00
	Pasang Titik Instalasi + Accessories Internet	Ttk	4.00	250,000.00	1,000,000.00
				Jumlah	2,000,000.00
				Jumlah XIII	25,000,000.00
XIX	PEKERJAAN INSTALASI TATA UDARA				
A.	LANTAI 1				
1	Pasang AC Window 2 PK	Bh	12.00	15,450,800.00	185,409,600.00
2	Pasang Instalasi AC dan Pembuangan	Ttk	12.00	250,000.00	3,000,000.00
				Jumlah	188,409,600.00
B.	LANTAI 2				
1	Pasang AC Window 2 PK	Bh	4.00	15,450,800.00	61,803,200.00
	Pasang AC Ceiling 1/2 PK	Bh	12.00	4,193,800.00	50,325,600.00

2	Pasang Instalasi AC dan Pembuangan	Ttk	16.00	250,000.00	4,000,000.00
				Jumlah	116,128,800.00
C.	LANTAI 3				
1	Pasang AC Window 2 PK	Bh	11.00	15,450,800.00	169,958,800.00
2	Pasang Instalasi AC dan Pembuangan	Ttk	11.00	250,000.00	2,750,000.00
				Jumlah	172,708,800.00
				Jumlah XIV	477,247,200.00

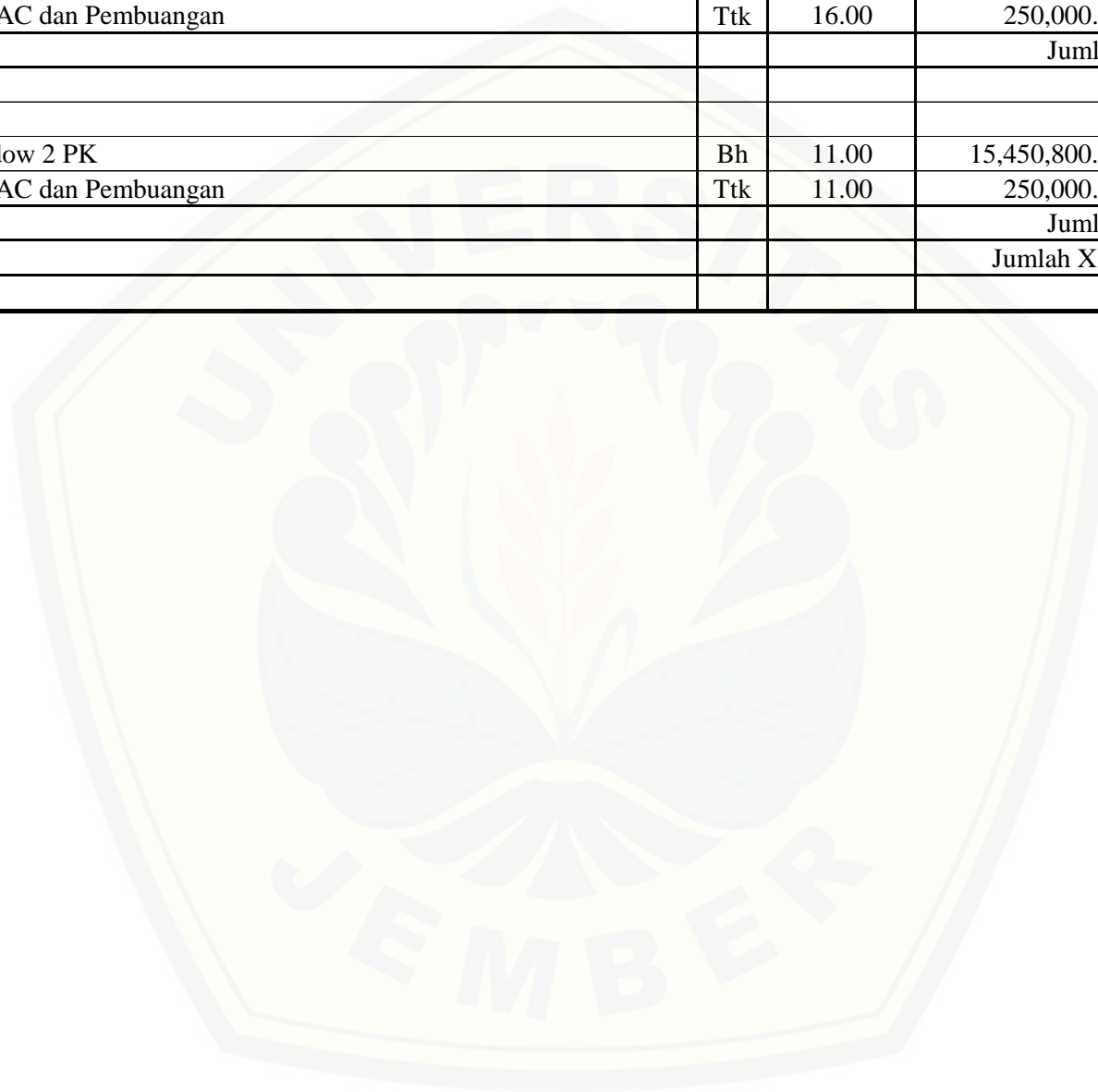

REKAPITULASI RENCANA ANGGARAN BIAYA (RAB)

PEKERJAAN : PEMBANGUNAN R. KULIAH AKUTANSI - FAK. EKONOMI
 LOKASI : KAMPUS UNIVERSITA JEMBER
 TAHUN : 2017

No.	URAIAN PEKERJAAN	JUMLAH
I	PEKERJAAN PERSIAPAN	10,249,240.00
II	PEKERJAAN TANAH	37,047,520.62
III	PEKERJAAN PONDASI	10,270,868.00
IV	PEKERJAAN BETON	809,727,802.30
V	PEKERJAAN ATAP	450,872,974.73
VI	PEKERJAAN PENANGKAL PETIR	18,164,800.00
VII	PEKERJAAN PASANGAN	62,922,016.75
VIII	PEKERJAAN PLESTERAN	143,201,392.84
IX	PEKERJAAN KUSEN DAN DAUN PINTU	412,244,040.00
X	PEKERJAAN LANTAI & KERAMIK	180,835,219.65
XI	PEKERJAAN PLAFOND	113,981,272.50
XII	PEKERJAAN PENGECATAN	83,024,582.11
XIII	PEKERJAAN INSTALASI SANITAIR DAN INST. AIR	114,410,467.60
XIV	PEKERJAAN AIR HUJAN	45,460,180.00
XV	PEKERJAAN LISTRIK	178,986,450.00
XVI	PEKERJAAN INSTALASI FIRE ALARM	11,000,000.00
XVII	PEKERJAAN INSTALASI KABEL TRY	21,917,250.00
XVIII	PEKERJAAN JARINGAN KOMPUTER DAN ITERNET	25,000,000.00
XIX	PEKERJAAN INSTALASI TATA UDARA	477,247,200.00
	JUMLAH BIAYA	3,206,563,277.09
	Ppn 10%	320,656,327.71
	JUMLAH TOTAL	3,527,219,604.80
	JUMLAH DIBULATKAN	3,527,219,000.00







